



Telit's Modules Software User Guide

1vv0300784 Rev. 20 – 2017-05-02

TELIT
TECHNICAL
DOCUMENTATION

SPECIFICATIONS ARE SUBJECT TO CHANGE WITHOUT NOTICE

NOTICES LIST

While reasonable efforts have been made to assure the accuracy of this document, Telit assumes no liability resulting from any inaccuracies or omissions in this document, or from use of the information obtained herein. The information in this document has been carefully checked and is believed to be reliable. However, no responsibility is assumed for inaccuracies or omissions. Telit reserves the right to make changes to any products described herein and reserves the right to revise this document and to make changes from time to time in content hereof with no obligation to notify any person of revisions or changes. Telit does not assume any liability arising out of the application or use of any product, software, or circuit described herein; neither does it convey license under its patent rights or the rights of others.

It is possible that this publication may contain references to, or information about Telit products (machines and programs), programming, or services that are not announced in your country. Such references or information must not be construed to mean that Telit intends to announce such Telit products, programming, or services in your country.

COPYRIGHTS

This instruction manual and the Telit products described in this instruction manual may be, include or describe copyrighted Telit material, such as computer programs stored in semiconductor memories or other media. Laws in the Italy and other countries preserve for Telit and its licensors certain exclusive rights for copyrighted material, including the exclusive right to copy, reproduce in any form, distribute and make derivative works of the copyrighted material. Accordingly, any copyrighted material of Telit and its licensors contained herein or in the Telit products described in this instruction manual may not be copied, reproduced, distributed, merged or modified in any manner without the express written permission of Telit. Furthermore, the purchase of Telit products shall not be deemed to grant either directly or by implication, estoppel, or otherwise, any license under the copyrights, patents or patent applications of Telit, as arises by operation of law in the sale of a product.

COMPUTER SOFTWARE COPYRIGHTS

The Telit and 3rd Party supplied Software (SW) products described in this instruction manual may include copyrighted Telit and other 3rd Party supplied computer programs stored in semiconductor memories or other media. Laws in the Italy and other countries preserve for Telit and other 3rd Party supplied SW certain exclusive rights for copyrighted computer programs, including the exclusive right to copy or reproduce in any form the copyrighted computer program. Accordingly, any copyrighted Telit or other 3rd Party supplied SW computer programs contained in the Telit products described in this instruction manual may not be copied (reverse engineered) or reproduced in any manner without the express written permission of Telit or the 3rd Party SW supplier. Furthermore, the purchase of Telit products shall not be deemed to grant either directly or by implication, estoppel, or otherwise, any license under the copyrights, patents or patent applications of Telit or other 3rd Party supplied SW, except for the normal non-exclusive, royalty free license to use that arises by operation of law in the sale of a product.

USAGE AND DISCLOSURE RESTRICTIONS

I. License Agreements

The software described in this document is the property of Telit and its licensors. It is furnished by express license agreement only and may be used only in accordance with the terms of such an agreement.

II. Copyrighted Materials

Software and documentation are copyrighted materials. Making unauthorized copies is prohibited by law. No part of the software or documentation may be reproduced, transmitted, transcribed, stored in a retrieval system, or translated into any language or computer language, in any form or by any means, without prior written permission of Telit

III. High Risk Materials

Components, units, or third-party products used in the product described herein are NOT fault-tolerant and are NOT designed, manufactured, or intended for use as on-line control equipment in the following hazardous environments requiring fail-safe controls: the operation of Nuclear Facilities, Aircraft Navigation or Aircraft Communication Systems, Air Traffic Control, Life Support, or Weapons Systems (High Risk Activities"). Telit and its supplier(s) specifically disclaim any expressed or implied warranty of fitness for such High Risk Activities.

IV. Trademarks

TELIT and the Stylized T Logo are registered in Trademark Office. All other product or service names are the property of their respective owners.

V. Third Party Rights



The software may include Third Party Right software. In this case you agree to comply with all terms and conditions imposed on you in respect of such separate software. In addition to Third Party Terms, the disclaimer of warranty and limitation of liability provisions in this License shall apply to the Third Party Right software.

TELIT HEREBY DISCLAIMS ANY AND ALL WARRANTIES EXPRESS OR IMPLIED FROM ANY THIRD PARTIES REGARDING ANY SEPARATE FILES, ANY THIRD PARTY MATERIALS INCLUDED IN THE SOFTWARE, ANY THIRD PARTY MATERIALS FROM WHICH THE SOFTWARE IS DERIVED (COLLECTIVELY "OTHER CODE"), AND THE USE OF ANY OR ALL THE OTHER CODE IN CONNECTION WITH THE SOFTWARE, INCLUDING (WITHOUT LIMITATION) ANY WARRANTIES OF SATISFACTORY QUALITY OR FITNESS FOR A PARTICULAR PURPOSE.

NO THIRD PARTY LICENSORS OF OTHER CODE SHALL HAVE ANY LIABILITY FOR ANY DIRECT, INDIRECT, INCIDENTAL, SPECIAL, EXEMPLARY, OR CONSEQUENTIAL DAMAGES (INCLUDING WITHOUT LIMITATION LOST PROFITS), HOWEVER CAUSED AND WHETHER MADE UNDER CONTRACT, TORT OR OTHER LEGAL THEORY, ARISING IN ANY WAY OUT OF THE USE OR DISTRIBUTION OF THE OTHER CODE OR THE EXERCISE OF ANY RIGHTS GRANTED UNDER EITHER OR BOTH THIS LICENSE AND THE LEGAL TERMS APPLICABLE TO ANY SEPARATE FILES, EVEN IF ADVISED OF THE POSSIBILITY OF SUCH DAMAGES.

APPLICABILITY TABLE

PRODUCTS

			SW Version	Technology
		GL865 SERIES	10.01.xx3	2G
		GE865-QUAD	10.01.xx3	
		GE864 V2 SERIES	10.01.xx3	
		GL868-DUAL	10.01.xx3	
		GE910 SERIES	13.00.xx9	
		GE910-QUAD V3	16.01.xx3	
		GE866-QUAD	16.01.xx3	
		GL865 V3 SERIES	16.01.xx3	
		GL868-DUAL V3	16.01.xx3	
		HE910 SERIES	12.00.xx8	3G
		UE910 SERIES	12.00.xx8	
		UL865 SERIES	12.00.xx8	
		UE866 SERIES	12.00.xx8	
		LE910 V2 SERIES	20.00.xx2	4G
		LE866 SERIES	23.00.xx2	

CONTENTS

NOTICES LIST	2
COPYRIGHTS	2
COMPUTER SOFTWARE COPYRIGHTS.....	2
USAGE AND DISCLOSURE RESTRICTIONS	3
I. License Agreements	3
II. Copyrighted Materials	3
III. High Risk Materials	3
IV. Trademarks	3
V. Third Party Rights	3
APPLICABILITY TABLE	4
CONTENTS	5
FIGURES LIST	12
TABLES LIST	12
AT COMMAND LIST	13
1. INTRODUCTION	14
1.1. Scope	14
1.2. Audience.....	14
1.3. Contact Information, Support	14
1.4. Text Conventions.....	15
1.5. Related Documents	16
2. PRELIMINARY INFORMATION	17
3. BASIC AT COMMANDS	18
3.1. The Main Serial Port	18
3.1.1. RTS/CTS handshaking	18
3.1.1.1. RTS control line	19
3.1.1.1.1. 2G Modules	19
3.1.1.1.2. 3G Modules	20
3.1.1.2. CTS control line	20
3.2. Serial Port Speed.....	21
3.2.1. 2G Modules	21
3.2.1.1. SW Ver. 10.xx.xxx, 16.xx.xxx.....	21
3.2.1.2. SW Ver. 13.xx.xxx	21

3.2.2.	3G Modules	22
3.2.2.1.	SW Ver. 12.xx.xxx	22
3.3.	Serial Ports Arrangements	23
3.3.1.	Auxiliary Serial Port Arrangement	23
3.3.1.1.	2G Modules	23
3.4.	AT Interface Style Selection	24
3.4.1.	2G Modules	24
3.4.2.	3G Modules	24
3.5.	AT Error Report Format	25
3.6.	Module Identification	25
3.7.	Select 2G or 3G Network	25
3.7.1.	2G Modules	26
3.7.2.	3G Modules	26
3.8.	Band Configuration	26
3.8.1.	2G Modules	26
3.8.2.	3G Modules	26
3.9.	SIM/USIM Management	27
3.9.1.	SIM Presence and PIN Request	27
3.9.2.	Enter PIN code	28
3.9.3.	Enter PUK code	28
3.9.4.	SIM Status	29
3.9.5.	SIM Detection Mode	30
3.9.6.	SIM/USIM Access File	31
3.9.7.	MSISDN	32
3.9.7.1.	2G Modules	32
3.9.7.2.	3G Modules	32
3.10.	Network Information	33
3.10.1.	Network Status	33
3.10.1.1.	2G Modules	33
3.10.1.2.	3G Modules	33
3.10.2.	Network Operator Identification	34
3.10.2.1.	2G Modules	35
3.10.2.2.	3G Modules	35
3.10.3.	Preferred Network Operator List	36
3.10.3.1.	2G Modules	36
3.10.3.2.	3G Modules	37
3.10.4.	Signal Strength & Quality	37

3.10.5.	Fast Network Status Check	38
3.10.5.1.	2G Modules	38
3.10.5.2.	3G Modules	40
3.10.6.	Network Survey	40
3.10.7.	BCCH Survey	41
3.10.8.	Enhanced Network Selection and AT&T functions	42
3.10.8.1.	2G Modules SW Ver. ≥ 10.00.xx5/16.00.xx2	42
3.10.8.1.1.	No AT&T SIM Card	42
3.10.8.1.2.	AT&T SIM card	42
3.10.8.2.	2G Modules SW Ver. ≥ 13.00.xx2	44
3.10.8.2.1.	No AT&T SIM cards	44
3.10.8.2.2.	AT&T SIM card	44
3.10.8.3.	3G Modules SW Ver. = 12.00.xx2	46
3.10.8.3.1.	No AT&T SIM cards	46
3.10.8.3.2.	AT&T SIM card	46
3.10.8.4.	3G Modules SW Ver. ≥ 12.00.xx3	47
3.10.8.4.1.	No AT&T SIM cards	47
3.10.8.4.2.	AT&T SIM card	48
3.11.	Voice Call Establishment – Originate	49
3.11.1.	Set Module in Voice Mode	49
3.11.2.	Dialing a Phone Number	50
3.11.3.	Disconnect a Call	50
3.11.4.	Answering an Incoming Call	50
3.11.5.	Audio Codec Information	50
3.11.6.	Setting Audio Codec	51
3.11.7.	Set Audio Path Active	52
3.11.7.1.	2G Modules Software Version 13.xx.xxx	52
3.11.7.2.	3G Modules	52
3.11.8.	Set Volume on Speaker	53
3.11.9.	Set Microphone Mute	53
3.11.10.	Hand Set Path Commands	53
3.11.10.1.	HS Microphone Gain	53
3.11.10.2.	HS Sidetone	54
3.11.10.3.	HS Echo Canceller	54
3.11.10.4.	HS Automatic Gain	55
3.11.10.5.	HS Noise Reduction	55
3.11.11.	Hands Free Path Commands	56

3.11.11.1.	HF Microphone Gain.....	56
3.11.11.2.	HF Sidetone.....	56
3.11.11.3.	HF Echo Cancellor.....	57
3.11.11.4.	HF Automatic Gain	57
3.11.11.5.	HF Noise Reduction.....	58
3.12.	CSD Data Call Establishing – Originate	58
3.12.1.	Set Module in ONLINE Mode.....	58
3.12.2.	Dialing a Phone Number.....	58
3.12.3.	Disconnect Data Call	59
3.12.4.	Set Modulation and Speed.....	59
3.12.4.1.	2G Modules	59
3.12.4.2.	3G Modules	60
3.12.5.	Modules Supporting Only Data Call	60
3.13.	GSM Single Numbering Scheme	61
3.13.1.	2G Modules	61
3.14.	TTY Feature	61
3.15.	Software Shutdown.....	61
4.	ADVANCED AT COMMANDS	62
4.1.	Call Management.....	62
4.1.1.	Identifying the Call Type	62
4.1.2.	Identify the Caller.....	62
4.1.3.	Calling Line Indication.....	63
4.1.3.1.	CLIR Service Status	63
4.1.3.2.	Restrict/Allow Caller Line ID Indication	64
4.1.4.	Call Barring Control	64
4.1.4.1.	Lock/Unlock the Module.....	65
4.1.4.1.1.	2G Modules	65
4.1.4.1.2.	3G Modules	65
4.1.4.2.	Call Barring Service Status	66
4.1.4.3.	Bar/Unbar All Incoming Calls	67
4.1.4.4.	Bar/Unbar Incoming Calls in International Roaming	68
4.1.4.5.	Bar/Unbar All Outgoing Calls	69
4.1.4.6.	Bar/Unbar All Outgoing International Calls.....	70
4.1.4.7.	Bar/Unbar All Outgoing Internat. Calls except to Home Country .	71
4.1.4.8.	Unbar All Calls.....	72
4.2.	DTMF Tones.....	73
4.3.	Encryption Algorithm.....	73

4.3.1.	2G Modules	73
4.3.2.	3G Modules	73
4.4.	SMS Management	74
4.4.1.	Select SMS Format Type	74
4.4.1.1.	Set Text Mode Parameters	74
4.4.1.2.	Character Sets.....	76
4.4.1.2.1.	IRA Character Set.....	77
4.4.1.2.2.	UCS2 Character Set	77
4.4.2.	Read SMSC Number	78
4.4.3.	Set SMSC Number	78
4.4.4.	Send a SMS	79
4.4.4.1.	2G Modules	79
4.4.4.2.	3G Modules	82
4.4.5.	Select/Check SMS Storage Type.....	82
4.4.5.1.	2G Modules	82
4.4.5.2.	3G Modules	83
4.4.6.	Select URC Behavior	83
4.4.6.1.	2G Modules	83
4.4.6.2.	3G Modules	85
4.4.7.	Store a SMS	85
4.4.7.1.	2G Modules	85
4.4.7.2.	3G Modules	86
4.4.7.3.	PDU Mode	87
4.4.8.	Send a Stored SMS	88
4.4.9.	Send a New SMS using GPRS service	88
4.4.10.	Delete an SMS	89
4.4.10.1.	2G Modules	90
4.4.11.	Read an SMS	91
4.4.12.	SMS Status.....	91
4.4.12.1.	2G Modules	92
4.4.13.	Cell Broadcast Service.....	93
4.4.14.	Read concatenated SMS	94
4.5.	Phonebooks.....	96
4.5.1.	Phonebook types	96
4.5.1.1.	2G Modules	96
4.5.1.2.	3G Modules	97
4.5.2.	Select Phonebook Memory Storage.....	97

4.5.2.1.	2G Modules	98
4.5.2.2.	3G Modules	99
4.5.3.	Search Phonebook Entries	99
4.5.4.	Read Phonebook Entries	100
4.5.5.	Write Phonebook Entry	100
4.5.6.	Delete Phonebook Entry	101
4.5.7.	Dial Phonebook Entry	101
4.6.	GSM Power Saving Modes	103
4.6.1.	Some clarifications.....	103
4.6.2.	CFUN=0 and 3G Modules.....	104
4.6.3.	CFUNs and the Main Serial Port.....	105
4.6.4.	CFUNs and Wake up Events	108
4.6.5.	CFUN Examples	111
4.6.5.1.	CFUN=0: Call, SMS, #QSS, +CALA	111
4.6.5.2.	CFUN=2: #QSS, +CALA.....	114
4.6.5.3.	CFUN=4: #QSS, +CALA.....	116
4.6.5.4.	CFUN=5: Call, SMS, +CALA.....	118
4.6.5.5.	CFUN=7: Call, SMS, +CALA.....	122
4.6.5.6.	CFUN=9: +CALA	125
4.6.5.7.	CFUN=10: +CALA	126
4.6.5.8.	CFUN=11: +CALA	127
4.7.	GPIO Pins.....	130
4.7.1.	Set GPIO Pin as OUTPUT	130
4.7.2.	Set GPIO Pin as INPUT	130
4.7.3.	GPIO Pin Status	130
4.7.4.	GPIO & Alternate Function	131
4.7.4.1.	GPIO4 Pin as RF Transmission Control.....	132
4.7.4.2.	GPIO5 Pin as RFTXMON OUTPUT.....	132
4.7.4.3.	GPIO6 Pin as ALARM OUTPUT	132
4.7.4.4.	GPIO7 Pin as BUZZER OUTPUT	132
4.7.4.5.	Set STAT_LED GPIO	133
4.7.4.6.	JAM GPIO	133
4.7.4.6.1.	2G Modules	133
4.7.4.6.2.	3G Modules	134
4.8.	Clock and Alarm Functions	135
4.8.1.	Clock	135
4.8.1.1.	Set Module Clock.....	135

4.8.1.2.	Read the Current Date and Time	136
4.8.1.3.	Automatic Data/Time updating.....	136
4.8.2.	Alarm.....	137
4.8.2.1.	Set Alarm.....	137
4.8.2.2.	Delete Alarm.....	138
4.8.2.3.	Recurrent Alarm.....	139
4.8.2.4.	Postpone Alarm Time	141
4.8.2.5.	Stop Alarm.....	141
4.8.2.6.	Alarm Status	142
4.8.2.7.	A simple Alarm Application	142
5.	TCP/IP PROTOCOL.....	144
5.1.	2G/3G Dialup Connection	144
5.1.1.	2G Modules	144
5.1.2.	3G Modules	144
5.2.	4G Modules and Default/Dedicated EPS Bearers.....	145
5.2.1.	Default EPS Bearer at UE Power on.....	146
5.2.1.1.	Change a Default EPS Bearer at UE Power on	147
5.2.2.	Establish a Default EPS Bearer	148
5.2.3.	Dedicated EPS Bearer.....	148
5.2.4.	AT#DUALAPN	149
5.2.4.1.	IP Easy Connection	149
5.2.4.2.	Dialup Connection	152
5.2.5.	AT#PDPAUTH.....	153
5.2.6.	AT#PDPAUTH & AT#NCM	154
6.	FIRMWARE UPDATE TOOL.....	159
6.1.	Xpf tool	159
6.1.1.	Update Procedure.....	159
6.1.1.1.	Command Line running Xfp tool.....	162
7.	GLOSSARY AND ACRONYMS	164
8.	DOCUMENT HISTORY	166

FIGURES LIST

Fig. 1: RTS/CTS control lines.....	18
Fig. 2: RTS Control Line.....	19
Fig. 3: CTS Control Line.....	20
Fig. 4: CFUN=7, Cyclic Sleep	106

TABLES LIST

Tab. 1: Serial Port Speed: Autobauding	21
Tab. 2: AT#SII & AT Parsers.....	23
Tab. 3: SIM/USIM	31
Tab. 4: CFUN Modes & Software Versions	103
Tab. 5: CFUN Modes & Wake up Events (con't)	109

AT COMMAND LIST

The following list, organized in alphabetical order, shows the AT commands covered by this User Guide. The number close to each command indicates the page of the first AT command occurrence.

AT#AUTOBND	26	AT#SII	23	AT+CMGW	85
AT#BND	26	AT#SIMDET	30	AT+CMSS	87
AT#CAP	52	AT#SLED	133	AT+CMUT	53
AT#CCLK	137	AT#SLEDSAV	133	AT+CNMI	83
AT#CEERNET	150	AT#SMSMODE	79	AT+COPS	34
AT#CMGLCONCINDEX	94	AT#WAKE	142	AT+CPBF	99
AT#CODEC	51	AT#WAKE	140	AT+CPBR	100
AT#CODECINFO	50	AT&P0	22	AT+CPBS	97
AT#CSURV	40	AT&W0	22	AT+CPBW	100
AT#DUALAPN	149	AT+CALA	137	AT+CPIN	27
AT#ENCALG	73	AT+CALD	138	AT+CPMS	82
AT#GPIO	130	AT+CAPD	141	AT+CPOL	36
AT#HFMICG	56	AT+CBST	59	AT+CRC	62
AT#HSMICG	53	AT+CCLK	135	AT+CREG	33
AT#JDRENH	133	AT+CFUN	103	AT+CRSM	32
AT#MONI	39	AT+CGACT	146	AT+CSCA	78
AT#NCM	148	AT+CGATT	146	AT+CSCB	93
AT#NITZ	136	AT+CGATT	89	AT+CSCS	76
AT#PDPAUTH	153	AT+CGCONTRDP	147	AT+CSIM	31
AT#QSS	29	AT+CGDCONT	146	AT+CSMP	74
AT#SERVINFO	39	AT+CGMM	25	AT+CSNS	61
AT#SGACT	148	AT+CGMR	25	AT+CSQ	37
AT#SHDN	61	AT+CGPADDR	150	AT+FCLASS	49
AT#SHFAGC	57	AT+CLCK	65	AT+IPR	21
AT#SHFEC	57	AT+CLIP	62	AT+SELINT	24
AT#SHFNR	58	AT+CLIR	63	AT+SNUM	32
AT#SHFSD	56	AT+CLVL	53	AT+WS46	26
AT#SHSAGC	55	AT+CMEE	25	ATD	50
AT#SHSEC	54	AT+CMGD	90	ATD*99#	144
AT#SHSNR	55	AT+CMGF	74	ATH	50
AT#SHSSD	54	AT+CMGL	91		

1. INTRODUCTION

1.1. Scope

This document covers the more significant standard and proprietary AT commands provided by Telit's modules. Several module features are described and for each one of them the related AT commands are explained through examples. This document is not an exhaustive description of the AT commands implemented on the Telit's modules series, its target is only to give you an entry point to the AT commands world.

1.2. Audience

The present User Guide is addressed to users that need to learn and use quickly standard and proprietary AT commands. The reader can learn the use of the AT commands through simple examples shown in the document, and then deepen the interested AT commands reading the documents [1]/[17] in accordance with the used module.

1.3. Contact Information, Support

For general contact, technical support services, technical questions and report documentation errors contact Telit Technical Support at:

- TS-EMEA@telit.com
- TS-AMERICAS@telit.com
- TS-APAC@telit.com
- TS-SRD@telit.com (for Short Range Devices)

Alternatively, use:

<http://www.telit.com/support>

For detailed information about where you can buy the Telit modules or for recommendations on accessories and components visit:

<http://www.telit.com>

Our aim is to make this guide as helpful as possible. Keep us informed of your comments and suggestions for improvements.

Telit appreciates feedback from the users of our information.

1.4. Text Conventions



Danger – This information **MUST** be followed or catastrophic equipment failure or bodily injury may occur.



Caution or Warning – Alerts the user to important points about integrating the module, if these points are not followed, the module and end user equipment may fail or malfunction.



Tip or Information – Provides advice and suggestions that may be useful when integrating the module.

All dates are in ISO 8601 format, i.e. YYYY-MM-DD.

1.5. Related Documents

- [1] AT Commands Reference Guide, 80000ST10025a
- [2] Refer to the specific "Telit Product Description" document
- [3] Refer to the specific "Telit Hardware User Guide" document
- [4] IP Easy User Guide, 80000ST10028A
- [5] ETSI GSM 07.07, 27.07
- [6] EVK2 User Guide, 1v0300704
- [7] ETSI GSM 03.38, 23.038
- [8] /
- [9] Device Requirements AT&T, Document Number 13340
- [10] Telit 3G Modules Ports Arrangements User Guide, 1v0300971
- [11] Enhanced JDR Technical Note, 30353NT11086A
- [12] ITU-T Recommendation E.164
- [13] ETSI GSM 11.11, 51.011, 31.101, 31.102
- [14] ITU-T Recommendation V.24
- [15] /
- [16] ETSI GSM 11.14, 51.014
- [17] Telit 3G Modules AT Commands Reference Guide, 80378ST10091A
- [18] Audio Setting Application Note, 80000NT10007A
- [19] ETSI GSM 27.005
- [20] Telit's Easy Scan User Guide, 1v0300972
- [21] Jamming Detection – HE910 Series Application Note, 80000NT11408A
- [22] GE910 Series Ports Arrangements User Guide, 1v0301049
- [23] IP Easy User Guide Application Note, 80000ST10028A
- [24] Virtual Serial Device Application Note, 80000NT10045A
- [25] NCM Protocol User Guide, 1v0301246
- [26] Telit LE910 V2 Series AT Commands Reference Guide, 80446ST10707A

2. PRELIMINARY INFORMATION

Before describing the AT commands use, it is needed to define a way to point out significant differences, when needed, between modules belonging to different series, or having different software versions.

- In 2G Modules sub-chapters (or under label in the text) are described AT commands examples concerning the modules supporting the 2G Technology only. Where needed, the guide specifies also the software version.
- In 3G Modules sub-chapters (or under label in the text) are described AT commands examples concerning the modules supporting the 2G/3G Technologies. Where needed, the guide specifies also the software version.
- If the AT command example is valid for all products, no labels or dedicated chapters are used.
- Chapter 5 is focusing on the Default/Dedicated EPS Bearer (4G modules)

The AT commands use specified in this guide assumes that the #SELINT=2 AT Interface Style is used.

Refer to document [1]/[17]/[26] in accordance with the module that you are using to have more information on the AT commands syntax, parameters, and parameters range.



In this guide is used the notation [x]/[y] to refer to documents of different modules. See the document in accordance with your module.

Refer to document [3] in accordance with the module that you are using to have information on the hardware. For example, serial ports, GPIO pins... etc.

Refer to document [18] to have detailed information on the audio architecture provided by the modules.

3. BASIC AT COMMANDS

3.1. The Main Serial Port

Here is the V.24 serial interface standard provided by the Main Serial Port of the modules. To have hardware information refer to document [3] in accordance with your module.

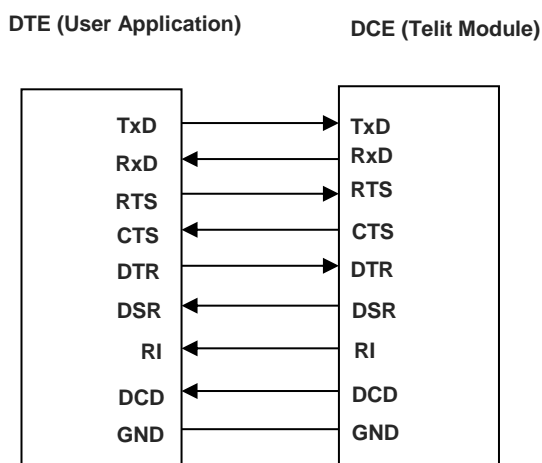

After power on, the module is ready to receive AT commands on its Main Serial Port. Its second serial port, called Auxiliary, is used for factory test.

For example, type in the following AT command to verify if the DTE/DCE connection is working.

```
AT
OK
```

Refer to § 3.2 to configure the speed of the Main Serial Port.

3.1.1. RTS/CTS handshaking

The next sub-chapters describe the RTS/CTS handshaking of the Main Serial Port.

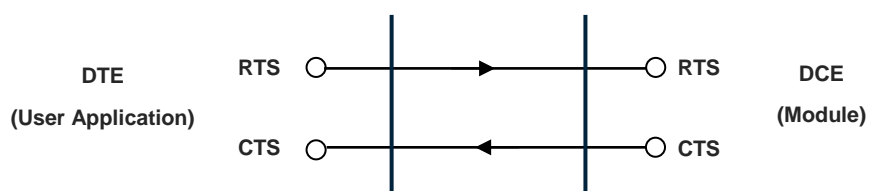

Fig. 1: RTS/CTS control lines

3.1.1.1. RTS control line

3.1.1.1.1. 2G Modules

The RTS control line indicates permission to the DCE (module) to send data to the DTE (user equipment). The module every GSM TDMA frame (4.61 ms) checks the RTS (output) of DTE. As soon as the RTS of the DTE is detected as not asserted, the module immediately stops the transmission of the bytes toward the DTE.

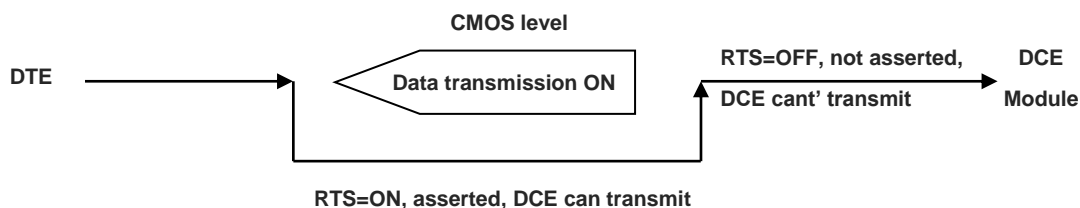

Fig. 2: RTS Control Line

The maximum number of characters that Telit Module can send to the DTE after the transition RTS asserted to RTS NOT asserted depends upon the used serial port speed. In any case, to consider delays due to software tasks priorities it is necessary to consider a detection interval equal to $4.61 \times 2 = 9.22$ ms.

Example:

- at 115200 8N1 the maximum number of transmitted characters (bytes) by DCE is 107;
- $115200 \text{ 8N1} \Rightarrow 115200 \text{ bit/s} = 11520 \text{ char/s} = 11.52 \text{ char/ms} = 106.2 \text{ char/GSM frame} \times 2$;
- at 57600 8N1 the maximum number of transmitted characters (bytes) by DCE is 54;
- at 9600 8N1 the maximum number of transmitted characters (bytes) by DCE is 9.

For the GE910 products (no V3) the number of transmitted characters is formed by two quantities:

- 288 characters: the number is fixed, regardless the selected speed,
- 53 is the max number of characters that are transmitted when the software detects the RTS transition after the max interval time equal to 4.61 ms. In this example the used speed is 115200 bits/s,
- in this example, the maximum number of transmitted characters is: $288 + 53 = 341$.

3.1.1.1.2. 3G Modules

HE910 Series

RTS control line indicates permission to the DCE (module) to send data to the DTE (user equipment). The low-high RTS transition generates an interrupt signal. Between the RTS transition and the interrupt signal recognition, the module can send at most one character toward DTE.

Suppose that the HE910 module is in ONLINE Mode and the DTE forces the RTS control line to high, see Fig. 2 . The data flow from the module to the DTE (download) is stopped. At the same time, the CTS control line is low - see Fig. 3 -, it means that the module can receive data from DTE (upload). Follow the steps below to force the module in the COMMAND Mode:

- Enter the escape sequence: +++
- Force the RTS to low. The Tx buffer of the module will be emptied, and the OK message will be displayed.
- Now, the module is in COMMAND Mode.

3.1.1.2. CTS control line

The CTS control line indicates permission to the DTE (user equipment) to send data to the DCE (module). The CTS (output) of the DCE is not asserted when the data in its receiver buffer is greater than 75% of its capacity, the DTE transmission is stopped. The CTS is asserted when data in the receiver buffer of the module is lower than 25% of its capacity, the DTE transmission starts again.

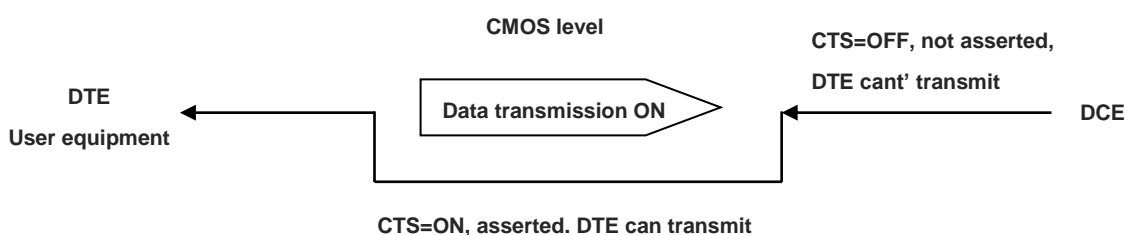

Fig. 3: CTS Control Line

3.2. Serial Port Speed

Modules	Software Version	Main Serial Port Speed Configuration
2G	10.00.xxx, 16.00.xxx	Autobauding
2G	13.00.xxx	No autobauding, 115200 bit/sec factory setting
3G	12.00.xxx	No autobauding, 115200 bit/sec factory setting

Tab. 1: Serial Port Speed: Autobauding

3.2.1. 2G Modules

Use the following AT command to configure the Main Serial Port speed.

AT+IPR=<rate>

Check the current Main Serial Port speed.

AT+IPR?

+IPR: 0 ← autobauding = 0, factory setting.

OK

3.2.1.1. SW Ver. 10.xx.xxx, 16.xx.xxx

Check the Main Serial Port speed range.

AT+IPR=?

+IPR:

(0,300,1200,2400,4800,9600,19200,38400,57600,115200),(0,300,1200,2400,4800,9600,1920,0,38400,57600,115200)

OK

3.2.1.2. SW Ver. 13.xx.xxx

Check the Main Serial Port speed range.

AT+IPR=?

+IPR: (300,1200,2400,4800,9600,19200,38400,57600,115200,230400,460800,921600)

OK

Set up the Main Serial Port speed to 38400 bps.

AT+IPR=38400

OK

Before entering the following AT commands, set up the DTE serial port speed to 38400 bps

AT&W0 ← store the setting on profile 0
OK

AT&P0 ← at power on use profile 0
OK

Check the current Main Serial Port speed.

AT+IPR?
+IPR: 38400
OK

3.2.2. 3G Modules

3.2.2.1. SW Ver. 12.xx.xxx

Use the following AT command to specify the Main Serial Port.

AT+IPR=<rate>

Check the current Main Serial Port speed.

AT+IPR?
+IPR: 115200 ← 115200 bps, factory setting
OK

Check the Main Serial Port speed range.

AT+IPR=?
+IPR: (300,1200,2400,4800,9600,19200,38400,57600,115200,230400,460800,921600)
OK

Set up the Main Serial Port speed to 38400 bps.

AT+IPR=38400
OK

Before entering the following AT commands, set up the DTE serial port to 38400 bps

AT&W0 ← store the setting on profile 0
OK

AT&P0 ← at power on use profile 0
OK

Check the current Main Serial Port speed.

AT+IPR?
+IPR: 38400
OK

3.3. Serial Ports Arrangements

To have exhaustive information on the serial ports arrangements, refer to document [22]/[10] in accordance with your module.

3.3.1. Auxiliary Serial Port Arrangement

3.3.1.1. 2G Modules

Use the following AT command to connect/disconnect the Auxiliary Serial Port to/from one of the three Services:

- AT1 Parser (Instance # 2)
- AT2 Parser (Instance # 3)
- Trace Service

AT#SII = <inst>

Examples

AT#SII?

#SII: 0 the Auxiliary Serial Port is connected to Trace Service; see the table below
OK

AT#SII=1

OK Auxiliary Serial Port is disconnected from Trace Service and connected to AT1parser. Main Serial Port is still connected to AT0 Parser as showed on the table.

Power on / AT#SII	AT0 Instance #1	AT1 Instance #2	AT2 Instance #3	Trace Service
Power on	Main Serial Port	X	X	Aux. Serial Port
AT#SII=1	Main Serial Port	Aux. Serial Port	X	X
AT#SII=2	Main Serial Port	X	Aux. Serial Port	X
AT#SII=0	Main Serial Port	X	X	Aux. Serial Port

Tab. 2: AT#SII & AT Parsers

To have hardware information on the Main and Auxiliary Serial Ports provided by the module, refer to document [3].

3.4. AT Interface Style Selection

Use the following AT command to check the current AT Interface Style.

```
AT#SELINT?
```

3.4.1. 2G Modules

After powering ON the module, check the current AT command Interface Style.

```
AT#SELINT?  
#SELINT: 0  
OK
```

Check the AT command Interfaces Set supported.

```
AT#SELINT=?  
#SELINT: (0-2)  
OK
```

Select the desired AT command Interface Set.

```
AT#SELINT=2  
OK
```

Select a wrong AT command Interface Set just to see the response.

```
AT#SELINT=7  
ERROR
```

Check that AT command Interface is active.

```
AT#SELINT?  
#SELINT: 2  
OK
```

3.4.2. 3G Modules

Check the supported AT Command Interface Style.

```
AT#SELINT=?  
#SELINT: (2)                    ← only interface style 2 is supported.  
OK
```

3.5. AT Error Report Format

Disable the Error Report in numerical and verbose format.

```
AT+CMEE=0  
OK
```

Enable the Error Report in numerical format.

```
AT+CMEE=1  
OK
```

Enable the Error Report in verbose format.

```
AT+CMEE=2  
OK
```

3.6. Module Identification

Use the following AT commands to verify the Software Versions and module identification.

Check the Software Versions.

```
AT+CGMR  
10.00.004  
OK
```

Check the module identification.

```
AT+CGMM  
GM862-QUAD  
OK
```

3.7. Select 2G or 3G Network

The following AT command selects the technology: 2G, 3G, or both.

```
AT+WS46=[<n>]
```



The <n> parameter is stored in NVM, and the command will take effect on the next power on. If on the air are present both technologies 2G and 3G, the second one is preferred.

3.7.1. 2G Modules

Select 2G Technology, the only available.

```
AT+WS46=12  
OK
```

3.7.2. 3G Modules

Examples

Select 2G Technology.

```
AT+WS46=12  
OK
```

Select 3G Technology only.

```
AT+WS46=22  
OK
```

Select both Technologies: 2G and 3G.

```
AT+WS46=25  
OK
```

3.8. Band Configuration

3.8.1. 2G Modules

The following AT command enables the automatic band selection:

```
AT#AUTOBND=2  
OK
```

The following AT command disables the automatic band selection (manual band selection):

```
AT#AUTOBND=0  
OK
```

In manual band selection the following AT command selects the current band:

```
AT#BND=[<band>]
```

Examples

```
AT#BND=0            ← selected band: GSM 900MHz + DCS 1800MHz  
OK
```

3.8.2. 3G Modules

The following AT command enables the automatic band selection:

```
AT#AUTOBND=2
OK
```

The following AT command disables the automatic band selection (manual band selection):

```
AT#AUTOBND=0
OK
```

In manual band selection the following AT command selects the current band for both technologies GERAN and UTRAN:

```
AT#BND=[<band>][,<UMTS band>]
```

Examples

```
AT#BND=0,0    ← selected band: GSM 900MHz + DCS 1800MHz 2100 MHz (FDD I)
OK
```



The module uses a band out of the two entered with the previous command. The selected band will be in accordance with the +WS46 command and the technologies available on the air.

Check the bands supported by the module

```
AT#BND=?
#BND: (0-3),(0-6)
OK
```

3.9. SIM/USIM Management

3.9.1. SIM Presence and PIN Request

The following AT command checks if the SIM device needs the PIN code:

```
AT+CPIN?
```

Examples

Assume that the SIM is inserted into the module and the PIN code is needed.

```
AT+CPIN?
+CPIN: SIM PIN
OK
```

Assume that the SIM is not inserted and Extended Error result code is not enabled. Check if PIN code is needed, just to see the response command:

```
AT+CPIN?
ERROR
```

Assume that the SIM is not inserted and Verbose Extended error result code is enabled. Check if PIN code is needed, just to see the response command:

AT+CPIN?

+CME ERROR: SIM not inserted

Assume that the SIM is not inserted and Numerical Extended error result code is enabled. Check if PIN code is needed, just to see the response command:

AT+CPIN?

+CME ERROR: 10

3.9.2. Enter PIN code

Use the following AT command to enter the PIN code:

AT+CPIN=<pin>

Examples

Assume to enter a wrong PIN code, and Extended Error result is not enabled.

AT+CPIN=1235

ERROR

Now, enter the right PIN code:

AT+CPIN=1234

OK

Enable Verbose Extended error result code:

AT+CMEE=2

OK

Enter a wrong PIN code:

AT+CPIN=1235

+CME ERROR: incorrect password.



After 3 PIN code failed attempts, the PIN code is no longer requested and the SIM is locked. Use SIM PUK to enter a new PIN code and unlock the SIM.

3.9.3. Enter PUK code

Enter the following AT command if PUK or PUK2 code is required:

AT+CPIN=<pin>[,<newpin>]



After 10 PUK code failed attempts, the SIM Card is locked and no longer available.

3.9.4. SIM Status

Use the following AT command to enable/disable the SIM Status Unsolicited Indication.

AT#QSS = <mode>

Example 1

Enable the unsolicited indication concerning the SIM status change.

AT#QSS=1 ← enable URCs: #QSS:0/1
OK

#QSS: 0 ← unsolicited indication: the SIM is extracted.

#QSS: 1 ← unsolicited indication: the SIM is inserted.

Example 2

AT#QSS=2 ← enable URCs: #QSS:0/1/2/3
OK

AT+IPR=19200 ← select the Main Serial Port speed = DTE speed
OK

AT&W0 ← store the setting on profile 0
OK

AT&P0 ← at Power on use profile 0
OK

Now, power off the module:

#QSS:1 ← unsolicited indication: SIM inserted

Now, power on the module:

#QSS:1 ← unsolicited indication: SIM inserted

AT+CPIN?
+CPIN: SIM PIN ← SIM is locked
OK

AT+CPIN=<PIN> ← enter PIN
OK

#QSS: 2 ← unsolicited indication: SIM is unlocked

#QSS: 3 ← unsolicited indication: SMS and Phonebook are accessible



The time interval between the two unsolicited indications (#QSS: 2 and #QSS: 3) depends from the number of SMS stored on the module and the Phonebook size.

3.9.5. SIM Detection Mode

Use the following AT command to manage the SIM Detection Mode:

AT#SIMDET=<mode>

Example

```
AT#SIMDET?
#SIMDET: 2,1
OK
```

2 = automatic SIM detection through SIMIN pin (Factory Setting)

1 = SIM inserted

Enable the unsolicited indication concerning the SIM status change.

AT#QSS=1

Now, extract the SIM

```
#QSS: 0      ← unsolicited indication: SIM is extracted
```

Now, insert the SIM

```
#QSS: 1      ← unsolicited indication: SIM is inserted
```

```
AT#SIMDET=0  ← simulate SIM not inserted, but it is still physically inserted
OK
```

```
#QSS: 0      ← unsolicited indication, but SIM is NOT physically extracted
```

```
AT#SIMDET?
#SIMDET: 0,1 ← 0 = simulate the status SIM not inserted, 1 = SIM is physically inserted
OK
```

Now, extract/insert the SIM, no unsolicited indication appears on DTE!

Extract the SIM again

```
AT#SIMDET=1  ← simulate SIM inserted, but it is still physically extracted
OK
```

```
AT#SIMDET?
#SIMDET: 1,0 ← 1 = simulate the status SIM inserted, 0 = SIM is physically not inserted
OK
```

Now, insert/extract the SIM, no unsolicited indication appears on DTE!

Extract the SIM and set automatic SIM detection

AT#SIMDET=2
OK

AT#SIMDET?
#SIMDET: 2,0 ← 2 = automatic SIM detection through SIMIN pin (Factory Setting),
OK 0 = SIM not inserted

Now, insert/extract the SIM, unsolicited indication appears again on DTE!

#QSS: 1 ← unsolicited indication: SIM is physically inserted

#QSS: 0 ← unsolicited indication: SIM is physically extracted

3.9.6. SIM/USIM Access File

SIM and USIM cards are accessible using two different protocols, the cards can support one or both protocols. Modules, in accordance with the installed software version, can access only SIM or both SIM/USIM cards. Refer to the table below:

Modules	Software Version	Cards supported	Support mode
2G	10.00.xxx, 13.00.xxx, 16.00.xxx	SIM/USIM	AT#ENASIM enables SIM protocol (factory setting) AT#ENASIM=1 enables USIM protocol
3G	12.00.xxx	SIM/USIM	Automatic detection: if the used card provides both protocols, the module selects the USIM protocol (it is the preferred).

Tab. 3: SIM/USIM

Use the AT+CSIM command to read/write SIM/USIM files. The format of the AT+CSIM parameters and the sequence of the AT+CSIM commands must be in accordance with the protocol card. The distinction between SIM and USIM <command> format is needed because the AT+CSIM command works directly on the card.

AT+CSIM=<length>,<command>

Example

AT+CSIM=1 ← Lock SIM interface
OK

....

To read/write card files refer to documents [13], [16].

....

AT+CSIM=0 ← Unlock SIM interface
OK

3.9.7. MSISDN

MSISDN is a number uniquely identifying a subscription in a GSM or UMTS mobile network. MSISDN is defined by the ITU-U Recommendation [12] which defines the numbering plan: a number uniquely identifies a public network termination point and typically consists of three fields, CC (Country Code), NDC (National Destination Code), and SN (Subscriber Number), up to 15 digits in total.

3.9.7.1. 2G Modules

The following AT command can be used to store the MSISDN on the assigned field (EF_MSISDN) of the SIM card.

AT+CRSM=<command>[,<file id>[,<P1>,<P2>,<P3>[,<data>]]]

Using this command, the user needs to know the structure of the field used by the SIM card to storage the MSISDN number, refer to [5], [13]. AT#SNUM is an AT command more "user friendly", it is valid also for USIM card. See the following example:

Before entering the MSISDN in international phone number format, it is mandatory to enter the command AT#ENS=1. It enables the features described on § 3.10.8.

AT#ENS=1
OK

Write phone number and memo string.

AT#SNUM=1,"+393X912Y45Z7","MY NUMBER"
OK

If the features activated with AT#ENS=1 are no longer needed, enter the command AT#ENS=0.

AT#ENS=0
OK

Read phone number and memo string

AT+CNUM
+CNUM: "MY NUMBER", "+393X912Y45Z7", 145
OK

3.9.7.2. 3G Modules

Referring to § 4.1.

Select the "ON" storage:

AT+CPBS="ON"
OK

Write a new record on the selected storage:

```
AT+CPBW=1,"+393X912Y45Z7",145,"MyNumber"  
OK
```

Read the just entered number:

```
AT+CPBF="MyNumber"  
+CPBF: 1," +393X912Y45Z7",145," MyNumber "  
OK
```

3.10. Network Information

3.10.1. Network Status

Enter the following AT command to verify if the module is registered on a network.

```
AT+CREG?
```

3.10.1.1. 2G Modules

Check if the module is registered.

```
AT+CREG?  
+CREG: 0,1            ← yes, it is registered.  
OK
```

Now, disconnect the antenna from the module and enter again the command.

```
AT+CREG?  
+CREG: 0,3  
OK
```

Connect again the antenna to the module and select the Network Registration Report format: Local Area Code and Cell Id.

```
AT+CREG=2  
OK
```

```
AT+CREG?  
+CREG: 2,1,55FA,12EB  
OK
```

Now, enter a wrong parameter just to see the result format when Verbose Extended Error result is enabled.

```
AT+CREG=9  
+CME ERROR: operation not supported
```

3.10.1.2. 3G Modules

Suppose that 2G and 3G technologies are present on the air.

Force the module in 2G mode.

```
AT+WS46=12  
OK
```

Select the Network Registration Report format: Local Area Code and Cell Id:

```
AT+CREG=2  
OK
```

```
AT+CREG?  
+CREG: 2,1,"D5BD","520F",0  
OK
```

Now, use the command AT+WS46=22 or AT+WS46=25 to force the module in 3G mode.

```
AT+WS46=25  
OK
```

Select the Network Registration Report format: Local Area Code and Cell Id:

```
AT+CREG=2  
OK
```

```
AT+CREG?  
+CREG: 2,1,"EF8D","52D2388",2  
OK
```

3.10.2. Network Operator Identification

Use the following AT command to query the module for Network Operators Identifications Codes and Names.

```
AT+COPS=?
```

3.10.2.1. 2G Modules

Assume that the module is registered on a network.

AT+COPS=?

```
+COPS: (2,"I TIM",,"22201"),(1,"MOBITEL",,"29341"),(3,"I WIND",,"22288"),(3,"vodafone
IT",,"22210"),(1,"Si.mobil",,"29340"),(1,"SI TUSMOBIL",,"29370"),,(0-4),(0,2)
OK
```

Now, disconnect the antenna and assume that Verbose Extended Error result is enabled. Enter again the previous AT command.

AT+COPS=?

```
+CME ERROR: no network service
```

3.10.2.2. 3G Modules

Assume that 2G and 3G technologies are present on the air.

Force the module in 2G mode.

AT+WS46=12

```
OK
```

Check if the module is in 2G mode.

AT+COPS?

```
+COPS: 0,0,"I TIM",0 ← yes, it is in 2G mode
OK
```

Collect information about 2G networks.

AT+COPS=?

```
+COPS: (2,"I TIM",,"22201",0),(1,"SI MOBITEL GSM",,"29341",0),(3,"I WIND",,"2228
8",0),(1,"SI VEGA 070",,"29370",0),(1,"SI.MOBIL",,"29340",0),,(0-4),(0,2)
OK
```

Now, use the command AT+WS46=22 or AT+WS46=25 to force the module in 3G mode.

AT+WS46=25

```
OK
```

Check if the module is in 3G mode

AT+COPS?

```
+COPS: 0,0,"I TIM",2 ← yes, it is in 3G mode
OK
```

Collect information about 3G and 2G networks.

AT+COPS=?

```
+COPS: (2,"I TIM",,"22201",2),(2,"I TIM",,"22201",0),(1,"SI MOBITEL GSM",,"29341
",0),(3,"I WIND",,"22288",2),(1,"SI.MOBIL",,"29340",0),(1,"3 ITA",,"22299",2),(3,"I
WIND",,"22288",0),
(1,"SI VEGA 070",,"29370",0),,(0-4),(0,2)
OK
```

3.10.3. Preferred Network Operator List

Use the following AT command to manage the Preferred Operator List stored on SIM.

AT+CPOL=[<index>]...

The AT+CPOL command has a different set of parameters in accordance with the module type. See the following two sub-chapters.

3.10.3.1. 2G Modules

Use the following AT command to manage the Preferred Operator List stored on SIM.

AT+CPOL=[<index>][,<format>[,<oper>]]

Check the supported number of operators in the SIM Preferred Operator List and the format:

AT+CPOL=?

+CPOL: (1-20),(2) ←The used SIM supports 20 positions; the supported format (2) is numeric
OK

Reading the entire list:

AT+CPOL?

+CPOL: 1,2,"20801"

+CPOL: 2,2,"20810"

+CPOL: 3,2,"23205"

+CPOL: 4,2,"22802"

+CPOL: 5,2,"29341"

.

+CPOL: 19,2,"23802"

+CPOL: 20,2,"24201"

OK

The meaning of the string "XXXYY" is: - XXX = Mobile Country Code

- YY = Mobile Network Code

Delete the first entry using a non-existent <format> value just to see the response when the Extended Error result code is enabled.

AT+CPOL=1,3

+CME ERROR: operation not supported

Now, delete the first entry using the right <format> value.

AT+CPOL=1,2

OK

Check if the first entry is deleted.

```

AT+CPOL?
+CPOL: 2,2,"20810"
+CPOL: 3,2,"23205"
.
+CPOL: 19,2,"23802"
+CPOL: 20,2,"24201"
OK

```

The entry on first position is deleted.

```

AT+CPOL=1,2,20801    ←Write a new entry in the first position
OK

```

Check if the new entry is written on first position:

```

AT+CPOL?
+CPOL: 1,2,"20801"    ←The new entry is written on first position
+CPOL: 2,2,"20810"
.
+CPOL: 20,2,"24201"
OK

```

3.10.3.2. 3G Modules

Use the following AT command to manage the Preferred Operator List stored on SIM.

```

AT+CPOL=[<index>][,<format>[,<oper>[,<GSM_Act>,<GSM_Compact_Act>,<UTRAN_ActT]]]

```

Check the supported number of operators in the SIM preferred operator list and the format:

```

AT+CPOL=?
+CPOL: (1-35),(2) ←The used SIM supports 35 positions; the supported format (2) is numeric
OK

```

```

AT+CPOL?
+CPOL: 1,2,"20801",1,0,1
+CPOL: 2,2,"21407",1,0,1
.
+CPOL: 35,2,"73001",1,0,1
OK

```

3.10.4. Signal Strength & Quality

Assume that the module is registered on a network that provides 2G or 3G technology. The following AT command returns the received signal strength & quality giving an indication about the radio link reliability.

```

AT+CSQ

```

Assume that the antenna is not connected to the module or network coverage is not present at all.

```

AT+CSQ
+CSQ: 99,99
OK

```

Now, the antenna is connected to the module and network coverage is present. Enter again the previous AT command:

```

AT+CSQ
+CSQ: 17,0      ← 17 = <rssi> = Received Signal Strength Indication
OK              0 = <ber> = Bit Error Rate

```

Now, a wrong parameter is entered just to see the result format when Verbose Extended Error result is enabled:

```

AT+CSQ?
+CME ERROR: operation not supported

```

3.10.5. Fast Network Status Check

Once the module is registered on a network, does not matter about the technology (2G or 3G), it is useful to know the received signal strength and the network on which the module is registered. This information is gathered by means of the following standard AT commands: +CREG, +COPS and +CSQ. These commands are not fast in the response due to network response time, especially the +COPS command. If the user objective is to keep his application as general as possible, he can use the standard AT command above mentioned.

Telit's modules provide proprietary AT commands to gather all the information in a faster and simpler way, they are:

- AT#MONI
- AT#SERVINFO

AT#MONI and AT#SERVINFO commands should be used only to collect network name and signal strength information. To check if the module is registered or it is looking for a suitable network to register on, use +CREG command. In fact, if the network signal is too weak and module loses the registration, until a new network is found the two commands report the last measured valid values and not the real ones. The TA (timing advance parameter) is valid only during a call.

Check network registration with +CREG command. When module is registered, query the module for network operator name and signal strength with AT#MONI command.

3.10.5.1. 2G Modules

The following examples are valid also for modules providing 3G Technology when they are forced in GSM mode by means of the AT+WS46=12 command.

Assume that the antenna is connected to the module and only serving cell information is needed.

Check if the module is using 2G Technology.

```

AT+COPS?
+COPS: 0,0,"I TIM",0
OK

```

Yes, it is using 2G Technology. Only the modules providing 2/3G Technologies return the last parameter. It gives information on access technology.

Select the Serving Cell:

AT#MONI=0

OK

Collect information:

AT#MONI

#MONI: I WIND BSIC:70 RxQual:0 LAC:55FA Id:12EB ARFCN:979 PWR:-75dbm TA:0

OK

The module is registered on "I WIND" network, the signal strength is -75dBm.

Now, disconnect the antenna from the module and trying to collect cell information just to see the format response:

AT#MONI

ERROR

OK

The antenna is again connected to the module and Serving Cell and Neighboring Cells information is needed. Select all available cells:

AT#MONI=7

OK

Collect information:

AT#MONI

#MONI:	Cell	BSIC	LAC	CellId	ARFCN	Power	C1	C2	TA	RxQual	PLMN
#MONI:	S	70	55FA	12EB	979	-75 dbm	29	29	0	0	I WIND
#MONI:	N1	75	55FA	1297	983	-86 dbm	18	18			
#MONI:	N2	70	55FA	12EA	985	-87 dbm	17	17			
#MONI:	N3	73	55FA	1D23	754	-100 dbm	2	16			
#MONI:	N4	72	55FA	12EC	977	-101 dbm	3	3			
#MONI:	N5	72	55FA	1D0D	751	-107 dbm	-5	-5			
#MONI:	N6	FF	FFFF	0000	1007	-107 dbm	-1	-1			

OK

Collect only the Serving Cell network Information.

AT#SERVINFO

#SERVINFO: 979,-75,"I WIND","22288",70,55FA,00,1,,"I",01,6

3.10.5.2. 3G Modules

Suppose that the 3G Technology is present on the air. Use the command AT+WS46=22 or AT+WS46=25 to force the module in 3G mode.

Examples

Check if the module is using 3G Technology:

```
AT+COPS?  
+COPS: 0,0,"I TIM",2  
OK
```

Yes, it is using 3G Technology.

Select the Serving Cell:

```
AT#MONI=0  
OK
```

Collect information:

```
AT#MONI  
#MONI: I TIM PSC:49 RSCP:-102 LAC:EF8D Id:52D2388 Eclo:-2.5 UARFCN:10638 PWR:-97  
dbm DRX:64 SCR:784  
OK
```

Use the following AT command to collect only the Serving Cell Information:

```
AT#SERVINFO  
#SERVINFO: 10638,-94,"I TIM","22201",49,EF8D,64,3,-101,"II",00  
OK
```

Use this command to get the current network status.

```
AT#RFSTS  
#RFSTS: "222 01",10638,49,-5.0,-95,-85,EF8D,00,-  
128,128,19,4,2,,52D2388,"2220102413217","I TIM",3,0  
OK
```

3.10.6. Network Survey

Use the following AT command to perform a quick survey of the channels belonging to the current band, refer to [20].

```
AT#CSURV [=<s>,<e>]
```



3G Modules do not support this command.

Examples

AT#BND?

#BND: 0

OK

AT#CSURV=4,8

Network survey started ...

arfcn: 7 bsic: 18 rxLev: -78 ber: 0.00 mcc: 222 mnc: 01 lac: 54717 cellId: 21007 cellStatus:
CELL_SUITABLE numArfcn: 3 arfcn: 7 13 27arfcn: 4 bsic: 16 rxLev: -85 ber: 0.00 mcc: 222 mnc: 01 lac: 54717 cellId: 21094 cellStatus:
CELL_SUITABLE numArfcn: 2 arfcn: 4 1021

arfcn: 8 rxLev: -92

arfcn: 6 rxLev: -93

arfcn: 5 rxLev: -98

Network survey ended

OK

3.10.7. BCCH Survey

Use the following AT command to perform a quick survey of the channels belonging to the current band. The survey stops as soon as <n> BCCH carriers are found.

AT#CSURVB = [<n>]

3G Modules do not support this command.

Examples

AT#CSURVB=2

Network survey started ...

arfcn: 104 bsic: 63 rxLev: -68 ber: 0.00 mcc: 222 mnc: 88 lac: 22010 cellId: 4737 cellStatus:
CELL_FORBIDDEN numArfcn: 3 arfcn: 114 989 995arfcn: 761 bsic: 57 rxLev: -72 ber: 0.00 mcc: 222 mnc: 88 lac: 22010 cellId: 7437 cellStatus:
CELL_FORBIDDEN numArfcn: 4 arfcn: 776 785 794 803

Network survey ended

OK

3.10.8. Enhanced Network Selection and AT&T functions

Use the following AT command to enable/disable the Enhanced Network Selection and the AT&T features. ENS works if the module and the SIM card are both ENS-capable.

AT#ENS=[<mode>]

AT#ENS?

#ENS: 0 ← factory setting

Using the factory setting, the module follows the European Standard R98/R4/R7.

Enter the following setting. Power OFF/ON the module to make active the new entered setting.

AT#ENS=1

OK

The following chapters describe the features enabled by the AT#ENS command for each module/software version.

3.10.8.1. 2G Modules SW Ver. ≥ 10.00.xx5/16.00.xx2

3.10.8.1.1. No AT&T SIM Card

- EONS features (refer to [9], § 15)
- ENS features for network selection (refer to [9], §13)
- special requirements for USSD strings (refer to [9], <CDR-GSM-255>)
- special ATD dial string format (ATDxxxxxPyyyyyy), refer to [9] <CDR-CON-3074>, <CDR-CON-3342>;
- **10.00.xx5**
if #AUTOBND=0 then, automatically, #AUTOBND is forced to 1. If #AUTOBND=2 (factory setting) no action is taken.
- **>= 10.00.xx6/16.00.xx2**
if #AUTOBND=0 then, automatically, #AUTOBND is forced to 2. If #AUTOBND=2 (factory setting) no action is taken.
- +PACSP AT command to display the PLMN Mode Bit read from CPHS file on SIM (refer to [9])
- AT#STIA=2,1 as default
- the max length of the telephone number that can be stored in SIM phonebooks is greater than the default value (20)
- AT#PLMNMODE=1 as default
- different coding and encoding for MCC and MNC for SAT functions (refer to [9])
- MWI messages (refer to [9], §16)

3.10.8.1.2. AT&T SIM card

Assume that #ENS=1. The module supports the features indicated in § 3.10.8.1.1, plus the following:

- Acting Home PLMN (refer to [9], § 12)

When AT#ENS=1, it is recommended to use the following setting:

AT#AUTOBND=2
AT#NITZ=7,X (X if the user wants the URC)
AT#SMSMODE=1

Regardless the SIM card used, the module supports the following features in accordance with the #ENS setting:

- Concerning Phonebook string management:

	BCD format	conversion	ASCII format
#ENS=1	0x0D (wild char)	→	?
	?	←	0x0D (wild char)
	0x0C	←	P
	0x0C	←	p

	BCD format	conversion	ASCII format
#ENS=0	0x0D (wild char)	→	@
	@	←	0x0D (wild char)
	0x0C	←	P

- #ENS=1: USSD MT event is notified via the tone associated to an SMS MT. If #ENS=0, the event is not notified via the tone, but is notified via an unsolicited message (if it is enabled).
- #ENS=1: the default GSM band parameter of #BND AT command is 3. If #ENS=0, the default GSM band parameter is 0.
- #ENS=1: #BND=1 or #BND=2 are not permitted. If #ENS=0, they are permitted.
- #ENS=1: ATD 0; and ATD 00; AT commands execute a call to the phone number 0 and 00 respectively. If #ENS=0, 0 and 00 are interpreted as USSD strings and sent to the network.
- #ENS=1: enter AT+CLCK="FD",1,PIN2 AT command to select the FD phonebook as current phonebook. If #ENS=0, enter the following commands:

AT+CPBS="FD"
ERROR

AT+CPIN=PIN2
OK

AT+CPBS="FD"
OK

In alternative of the three above listed AT commands the following one can be used:

AT+CLCK="FD",1,PIN2

- #ENS=1: after activating the context via AT+CGACT=1,<cid> AT commands, the DNS information is not received. Enter ATD*99***1# to execute the dial up. If #ENS=0, after activating the context via AT+CGACT=1,<cid> AT commands, the DNS information is received. Enter ATD*99***1# to execute the dial up.

3.10.8.2. 2G Modules SW Ver. ≥ 13.00.xx2

3.10.8.2.1. No AT&T SIM cards

The module supports the following features independently from the #ENS setting:

- EONS features (refer to [9], § 15)
- special requirements for USSD strings (refer to [9], <CDR-GSM-255>)
- special ATD dial string format (ATDxxxxxPyyyyyy), refer to [9] <CDR-CON-3074>, <CDR-CON-3342>;
- +PACSP AT command to display the PLMN Mode Bit read from CPHS file on SIM (refer to [9])
- the max length of the telephone number that can be stored in SIM phonebooks is greater than the default value (20)

The module supports the following features when #ENS=1:

- If #AUTOBND=0 then, automatically, #AUTOBND is forced to 2. If #AUTOBND=2 (factory setting) no action is taken.
- AT#BND supports only values 0 and 3
- AT#STIA=2,1 as default
- different coding and encoding for MCC and MNC for SAT functions (refer to [9])
- MWI messages (refer to [9], §16)
- ENS features for Network selection (refer to [9], §13)
- AT#PLMNMODE=1 as default

3.10.8.2.2. AT&T SIM card

Assume that #ENS=1. The module supports the features indicated in § 3.10.8.2.1, plus the following:

- Acting Home PLMN (refer to [9], § 12)

When AT#ENS=1, it is recommended to use the following setting:

AT#AUTOBND=2
AT#NITZ=7,X (X if the user wants the URC)
AT#SMSMODE=1

Regardless the SIM card used, the module supports the following features in accordance with the #ENS setting:

- Concerning Phonebook string management:

	BCD format	conversion	ASCII format
#ENS=1	0x0D (wild char)	→	?
	?	←	0x0D (wild char)
	0x0C	←	P
	0x0C	←	p

	BCD format	conversion	ASCII format
#ENS=0	0x0D (wild char)	→	@
	@	←	0x0D (wild char)
	0x0C	←	P

- #ENS=1: USSD MT event is notified via the tone associated to an SMS MT. If #ENS=0, the event is not notified via the tone, but is notified via an unsolicited message (if it is enabled).
- #ENS=1: the default GSM band parameter of #BND AT command is 3. If #ENS=0, the default GSM band parameter is 0.
- #ENS=1: #BND=1 or #BND=2 are not permitted. If #ENS=0, they are permitted.
- #ENS=1: ATD 0; and ATD 00; AT commands execute a call to the phone number 0 and 00 respectively. If #ENS=0, 0 and 00 are interpreted as USSD strings and sent to the network.
- #ENS=1: after activating the context via AT+CGACT=1,<cid> commands, the DNS information is not received. Enter ATD*99***1# to execute the dial up. If #ENS=0, after activating the context via AT+CGACT=1,<cid> commands, the DNS information is received. Enter ATD*99***1# to execute the dial up

3.10.8.3. 3G Modules SW Ver. = 12.00.xx2

3.10.8.3.1. No AT&T SIM cards

Assume that #ENS=1. The module supports:

- EONS features (refer to [9], § 15)
- special requirements for USSD strings (refer to [9], <CDR-GSM-255>
- special ATD dial string format (ATDxxxxxPyyyyyy), refer to [9] <CDR-CON-3074>, <CDR-CON-3342>;
- If #AUTOBND=0 then, automatically, #AUTOBND is forced to 2. If #AUTOBND=2 (factory setting) no action is taken.
- AT#BND supports only values 0 and 3, no restriction on second parameter
- +PACSP AT command to display the PLMN Mode Bit read from CPHS file on SIM (refer to [9])
- AT#STIA=2,1 as default
- the max length of the telephone number that can be stored in SIM phonebooks is greater than the default value (20)
- different coding and encoding for MCC and MNC for SAT functions (refer to [9])
- MWI messages (refer to [9], §16)

3.10.8.3.2. AT&T SIM card

Assume that #ENS=1. The module supports the features indicated in § 3.10.8.3.1, plus the following:

- Acting Home PLMN (refer to [9], § 12)

When **AT#ENS=1**, it is recommended to use the following setting:

AT#AUTOBND=2

AT#NITZ=7,X (X if the user wants the URC)

Regardless the SIM card used, the module supports the following features in accordance with the #ENS setting:

- Concerning Phonebook string management:

	BCD format	conversion	ASCII format
#ENS=1	0x0D (wild char)	→	?
	?	←	0x0D (wild char)
	0x0C	←	P
	0x0C	←	p

	BCD format	conversion	ASCII format
#ENS=0	0x0D (wild char)	→	@
	@	←	0x0D (wild char)
	0x0C	←	P

- #ENS=1: USSD MT event is notified via the tone associated to an SMS MT. If #ENS=0 the event is not notified via the tone, but is notified via an unsolicited message (if it is enabled).
- #ENS=1: the default GSM band parameter of #BND AT command is 3. If #ENS=0, the default GSM band parameter is 0.
- #ENS=1: #BND=1 or #BND=2 are not permitted. If #ENS=0, they are permitted.
- #ENS=1: ATD 0; and ATD 00; AT commands execute a call to the phone number 0 and 00 respectively. If #ENS=0, 0 and 00 are interpreted as USSD strings and sent to the network.
- #ENS=1: after activating the context via AT+CGACT=1,<cid> commands, the DNS information is not received. Enter ATD*99***1# to execute the dial up. If #ENS=0, after activating the context via AT+CGACT=1,<cid> commands, the DNS information is received. Enter ATD*99***1# to execute the dial up

3.10.8.4. 3G Modules SW Ver. ≥ 12.00.xx3

3.10.8.4.1. No AT&T SIM cards

The module supports the following features independently from the #ENS setting:

- EONS features (refer to [9], § 15)
- special requirements for USSD strings (refer to [9], <CDR-GSM-255>
- special ATD dial string format (ATDxxxxxPyyyyyy), refer to [9] <CDR-CON-3074>, <CDR-CON-3342>;
- +PACSP AT command to display the PLMN Mode Bit read from CPHS file on SIM (refer to [9])
- the max length of the telephone number that can be stored in SIM phonebooks is greater than the default value (20)

The module supports the following features when #ENS=1:

- If #AUTOBND=0 then, automatically, #AUTOBND is forced to 2. If #AUTOBND=2 (factory setting) no action is taken.
- AT#BND supports only values 0 and 3, no restriction on second parameter
- AT#STIA=2,1 as default
- different coding and encoding for MCC and MNC for SAT functions (refer to [9])
- MWI messages (refer to [9], §16)

3.10.8.4.2. AT&T SIM card

Assume that #ENS=1. The module supports the features indicated in § 3.10.8.4.1, plus the following:

- Acting Home PLMN (refer to [9], § 12)

When **AT#ENS=1**, it is recommended to use the following setting:

AT#AUTOBND=2

AT#NITZ=7,X (X if the user wants the URC)

Regardless the SIM card used, the module supports the following features in accordance with the #ENS setting:

- Concerning Phonebook string management:

	BCD format	conversion	ASCII format
#ENS=1	0x0D (wild char)	→	?
	?	←	0x0D (wild char)
	0x0C	←	P
	0x0C	←	p

	BCD format	conversion	ASCII format
#ENS=0	0x0D (wild char)	→	@
	@	←	0x0D (wild char)
	0x0C	←	P

- #ENS=1: USSD MT event is notified via the tone associated to an SMS MT. If #ENS=0, the event is not notified via the tone, but is notified via an unsolicited message (if it is enabled).
- #ENS=1: the default GSM band parameter of #BND AT command is 3. If #ENS=0, the default GSM band parameter is 0.
- #ENS=1: #BND=1 or #BND=2 are not permitted. If #ENS=0, they are permitted.
- #ENS=1: ATD 0; and ATD 00; AT commands execute a call to the phone number 0 and 00 respectively. If #ENS=0, 0 and 00 are interpreted as USSD strings and sent to the network.
- #ENS=1: AT+CFUN=0 is the same of AT+CFUN=4. If #ENS=0, +CFUN=0 and +CFUN=4 have the standard behavior.

- #ENS=1: the Radio Policy Management (RPM) is supported. If #ENS=0, RPM is not supported.
- #ENS=1: the default class parameter is 12 (AT#MSCLASS=12). If #ENS=0, the default class parameter is 33.
- #ENS=1: the following CPC features are disabled:
 - HSPA and HSPA+ 7.4 HSPA+ <CDR-HSD-491> UL DPCCCH Gating (Uplink DTX)
 - HSPA and HSPA+ 7.4 HSPA+ <CDR-HSD-492> E-DCH Tx Start Timer Restriction (Uplink DRX)
 - HSPA and HSPA+ 7.4 HSPA+ <CDR-HSD-493> Downlink DRX
 - HSPA and HSPA+ 7.4 HSPA+ <CDR-HSD-494> New UL DPCCCH Slot Format
 - HSPA and HSPA+ 7.4 HSPA+ <CDR-HSD-496> CQI Reporting Reduction

If #ENS=0, the features are enabled.

- #ENS=1: after power on the module executes the SIM reading and the network registration in sequential way. The call establishment is immediately available after the network registration. If #ENS=0, the module executes the SIM reading and the network registration in parallel. It can happen that the module is registered, but the reading SIM is not ended, for this reason wait for some seconds after network registration before calling.
- #ENS=1: after activating the context via AT+CGACT=1,<cid> commands, the DNS information is not received. Enter ATD*99***1# to execute the dial up. If #ENS=0, after activating the context via AT+CGACT=1,<cid> commands, the DNS information is received. Enter ATD*99***1# to execute the dial up

3.11. Voice Call Establishment – Originate

Before setting up the Voice Call, it is assumed that Telit Module is registered on a network and the signal strength is enough to carry on a reliable radio link.



The following sub-chapters introduce AT commands regarding the audio section of the modules. To have detailed information about the audio architecture and the related topics refer to document [18].

3.11.1. Set Module in Voice Mode

Use the following AT command to set up the module for a Voice Call:

```
AT+FCLASS=8
OK
```



+FCLASS=8 command may be omitted if the “;” modifier is added at the end of the ATD command, after the entered phone number.

3.11.2. Dialing a Phone Number

Use the following AT command to dial up a phone number.

```
ATD<number>[:]
```

Examples

Assume that the module is set in voice mode: AT+FCLASS=8 has been executed. After that, call the national number 040-4X92XYX.

```
ATD 0404X92XYX  
OK
```

Now, call the national number 040-4X92XYX in international format +39-040-4X92XYX.

```
ATD +390404X92XYX  
OK
```

Call the national number 040-4X92XYX in international format +39-040-4X92XYX. The module is not set in voice mode (AT+FCLASS=8 has not been executed). In this case to perform the Voice Call the User must use the “;” character at the end of the command.

```
ATD +390404X92XYX;  
OK
```

3.11.3. Disconnect a Call

Use the following AT command to hang up the current Voice Call:

```
ATH  
OK
```

3.11.4. Answering an Incoming Call

When an Incoming Call is recognized, the module sends an Unsolicited Code to DTE. Use the following AT command to answer to the call.

```
ATA  
OK
```

3.11.5. Audio Codec Information

This example is valid for both Technologies: 2G and 3G. Even if the module is registered on 3G network, usually the Operator assigns to the module a GSM channel to carry on a voice call. Use the following AT command to get codec information about a call..

```
AT#CODECINFO = <format>,<mode>  
OK
```

Example

AT#CODECINFO=1,1 ← enable codec information
OK

ATD<phone number>;
#CODECINFO: "HAMR","FR","EFR","HR","FAMR","HAMR"
OK

NO CARRIER ← remote hang up
#CODECINFO: "None","FR","EFR","HR","FAMR","HAMR"

3.11.6. Setting Audio Codec

This example is valid for both Technologies: 2G and 3G. Even if the module is registered on 3G network, usually the Operator assigns to the module a GSM channel to carry on a voice call. Use the following AT command to select a codec during a call.

AT#CODEC = <codec>
OK

Example

AT#CODEC?
#CODEC: 0 ← all the codec are enabled
OK

AT#CODECINFO=1,1 ← enable codec information
OK

ATD<phone number>; ← establish the call
#CODECINFO: "HAMR","FR","EFR","HR","FAMR","HAMR"
OK

NO CARRIER ← remote hang up
#CODECINFO: "None","FR","EFR","HR","FAMR","HAMR"

AT#CODEC=1 ← select FR mode
OK

ATD<phone number>; ← establish the call
#CODECINFO: "FR","FR"
OK

NO CARRIER ← remote hang up
#CODECINFO: "None","FR"

3.11.7. Set Audio Path Active

The present chapter gives a short description about the AT commands that manage the HS and HF audio paths provided by the modules. Not all modules provide two audio paths, see document [3]. The modules that provide two audio paths feature the capability to switch between them using software or hardware mode.

When your module provides two physical audio paths, use the following AT command to switch between them:

```
AT#CAP=<n>
OK
```

Examples 1:

```
AT#CAP=2           ← Use software mode to select HS audio path
OK
```

Examples 2

```
AT#CAP=1           ← Use software mode to select HF audio path
OK
```

Examples 3

```
AT#CAP=0           ← Use hardware mode to select audio path
OK
```

After entering the previous command select the audio path by means of the pin AXE, refer to [3]:

- pin AXE = HIGH to select HS audio path.
- pin AXE = LOW to select HF audio path.



The audio paths can be switched also during a call in both ways. When hardware control is not used, AXE pin can be left unconnected.

3.11.7.1. 2G Modules Software Version 13.xx.xxx

AT#CAP=<n> is a dummy command, returns OK response and no actions are performed by the module. It has been introduced for backward compatibility reasons.

3.11.7.2. 3G Modules

AT#CAP=<n> is a dummy command, returns OK response and no actions are performed by the module. It has been introduced for backward compatibility reasons.

3.11.8. Set Volume on Speaker

Use the following AT command to set up the output volume level on the active audio path:

```
AT+CLVL=<vol>  
OK
```

If the used module provides two audio paths (HS and HF), when moving from one path to the new one, the volume level does not change.

3.11.9. Set Microphone Mute

The following AT command mutes the microphone of the active path:

```
AT+CMUT=1  
OK
```

Check the microphone setting:

```
AT+CMUT?  
+CMUT: 1  
OK
```

3.11.10. Hand Set Path Commands

Refer to chapter 0

3.11.10.1. HS Microphone Gain

Use the following AT command to set up microphone input gain:

```
AT#HSMICG=<n>
```

Examples

Check the available gain levels

```
AT#HSMICG=?  
#HSMICG: (0-7)  
OK
```

Check the current gain level

```
AT#HSMICG?  
#HSMICG: 0  
OK
```

Set up a new gain level

```
AT#HSMICG=1  
OK
```

3.11.10.2. HS Sidetone

Use the following AT command to enable/disable the sidetone on HS audio path.

AT#SHSSD=<mode>

Examples

Check the available values

```
AT#SHSSD =?  
#SHSSD: (0-1)  
OK
```

Check the current value

```
AT#SHSSD?  
#SHSSD: 0  
OK
```

Enable sidetone

```
AT#SHSSD=1  
OK
```

3.11.10.3. HS Echo Canceller

Use the following AT command to enable/disable the echo canceller function on HS audio path.

AT#SHSEC=<mode>

Examples

Check the available values

```
AT#SHSEC =?  
#SHSEC: (0-1)  
OK
```

Check the current value

```
AT#SHSEC?  
#SHSEC: 0  
OK
```

Enable echo canceller function

```
AT#SHSEC=1  
OK
```

3.11.10.4. HS Automatic Gain

Use the following AT command to enable/disable the automatic gain control function on HS audio path.

AT#SHSAGC=<mode>

Examples

Check the available values

```
AT# SHSAGC =?  
#SHSAGC: (0-1)  
OK
```

Check the current value

```
AT# SHSAGC?  
# SHSAGC: 0  
OK
```

Enable automatic gain control function

```
AT# SHSAGC =1  
OK
```

3.11.10.5. HS Noise Reduction

Use the following AT command to enable/disable the noise reduction function on HS audio path.

AT#SHSNR=<mode>

Examples

Check the available values

```
AT# SHSNR =?  
#SHSNR: (0-1)  
OK
```

Check the current value

```
AT# SHSNR?  
# SHSNR: 0  
OK
```

Enable the noise reduction function

```
AT# SHSNR =1  
OK
```

3.11.11. Hands Free Path Commands

The Hands Free (HF) Path Commands showed on the following sub-chapters are dummy commands for the Modules that do not provide the HF audio path, refer to chapter 0. The commands return OK response and no actions are performed by the Modules. This solution was adopted for backward compatibility reasons.

3.11.11.1. HF Microphone Gain

Use the following AT command to set up the microphone input gain:

AT#HFMICG=<n>

Examples

Check the available gain levels

```
AT#HFMICG=?  
#HFMICG: (0-7)  
OK
```

Check the current gain level

```
AT#HFMICG?  
#HFMICG: 0  
OK
```

Set up a new gain level

```
AT#HFMICG=1  
OK
```

3.11.11.2. HF Sidetone

Use the following AT command to enable/disable the sidetone on HF audio path.

AT#SHFSD=<mode>

Examples

Check the available values

```
AT#SHFSD=?  
#SHFSD: (0-1)  
OK
```

Check the current value

```
AT#SHFSD?  
#SHFSD: 0  
OK
```

Enable sidetone

```
AT#SHFSD=1  
OK
```

3.11.11.3. HF Echo Canceller

Use the following AT command to enable/disable the echo canceller function on HF audio path.

AT#SHFEC=<mode>

Examples

Check the available values

```
AT#SHFEC =?  
#SHFEC: (0-1)  
OK
```

Check the current value

```
AT#SHFEC?  
#SHFEC: 0  
OK
```

Enable echo canceller function

```
AT#SHFEC=1  
OK
```

3.11.11.4. HF Automatic Gain

Use the following AT command to enable/disable the automatic gain control function on HF audio path.

AT#SHFAGC=<mode>

Examples

Check the available values

```
AT# SHFAGC =?  
#SHFAGC: (0-1)  
OK
```

Check the current value

```
AT# SHFAGC?  
# SHFAGC: 0  
OK
```

Enable automatic gain control function

```
AT# SHFAGC =1  
OK
```

3.11.11.5. HF Noise Reduction

Use the following AT command to enable/disable the noise reduction function on HF audio path.

AT#SHFNR=<mode>

Examples

Check the available values

```
AT# SHFNR =?  
#SHFNR: (0-1)  
OK
```

Check the current value

```
AT# SHFNR?  
# SHFNR: 0  
OK
```

Enable the noise reduction function

```
AT# SHFNR =1  
OK
```

3.12. CSD Data Call Establishing – Originate

Before setting up the CSD Data Call (not GPRS), it is assumed that Telit Module is registered on a network and the signal strength is enough to carry on a reliable radio link.

3.12.1. Set Module in ONLINE Mode

Use the following AT command to set up the module for a Data Call:

```
AT+FCLASS=0  
OK
```



+FCLASS setting is stored in NVM, so there is no need to repeat this command if +FCLASS setting is not required to change.

3.12.2. Dialing a Phone Number

Use the following AT command to dial a phone number:

ATD<number>

Examples

Call the national number 040-4X92XYX. The module is set in ONLINE Mode (**AT+FCLASS=0** has been executed).

ATD0404X92XYX
CONNECT 9600

Call the national number 040-4X92XYX in international format +39-40-4X92XYX. The module is set in ONLINE Mode (**AT+FCLASS=0** has been executed).

ATD+39404X92XYX
CONNECT 9600

The ATD response is returned when the modem handshake is over; it takes an interval of time depending from several factors (Network Operator, communication speed, etc.). Wait for this time before doing anything: when the module is doing the handshake, entering any character closes the handshake and aborts the call.

3.12.3. Disconnect Data Call

During the data call, the module is in ONLINE Mode (ON Line) and if any AT command is entered it is discarded and not executed. Before typing in the ATH command to close the call, the Escape Sequence (+++) must be used to enter the COMMAND Mode. No characters must be entered between two consecutive "+" characters forming the Escape Sequence.

Assume that a CSD Data Call is in progress. To exit the ONLINE Mode, do the following actions:

- Enter the Escape Sequence: +++
- Wait for the Escape Sequence pause time (see AT512 command, refer to [1]/[17]).
- Wait for the response OK.

Now, the module is in COMMAND Mode. Enter the following command.

ATH
NO CARRIER

3.12.4. Set Modulation and Speed

The Data Connection can be established using different speeds, bearer services, connection element. The connection mode can be selected with the following AT command:

AT+CBST[=<speed>[,<name>[,<ce>]]]
OK

3.12.4.1. 2G Modules

Examples

AT+CBST=? ← Check the supported range
+CBST: (0-4,6,7,14,65,66,68,70,71,75),(0),(0,1)
OK

AT+CBST? ← Read current values
 +CBST: 0,0,1
 OK

AT+CBST=1,0,1 ← Setting new speed
 OK

AT+CBST? ← Check if new speed value is set
 +CBST: 1,0,1
 OK



It is recommended to use the Non Transparent mode to avoid the reception of noise characters.

3.12.4.2. 3G Modules

AT+CBST=? ← Check the supported range
 +CBST: (0,4-7,12,14-17,68,70,71,75,79-84,115,116,120,121,130-134),(0),(0,1)
 OK

3.12.5. Modules Supporting Only Data Call

These modules do not feature the capability to manage Mobile Originated and Mobile Terminated Voice calls, they provide Data only:

ATD<phone number>; ← the voice call is not supported
 NO CARRIER

ATA ← answer to an incoming call is not supported
 ERROR

The following command is supported, but it does not work for an incoming voice calls. The automatic answer is not performed.

ATS0=<number of rings>
 OK



Even though the incoming voice call is not supported, when one is active the RING message is displayed on the DTE. The RING message persists until the call is active. Remind that ATA command is not available and ATS0 command does not work with the incoming voice call. Use the ATH command to drop down the call.

3.13. GSM Single Numbering Scheme

3.13.1. 2G Modules

Most Network Operators use a primary phone number associated to the voice service and a secondary phone number to data and fax. If the Operator employs a GSM Single Numbering Scheme, the voice and data number is the same. To select the bearer to be used when a mobile terminated Single Numbering Scheme call is established, use the following AT command.

AT+CSNS=<mode>

Example 1

```
AT+CSNS=0          ← voice (factory default)
OK
RING
RING
ATA
```

voice channel is ON

Example 2

```
AT+CSNS=2          ← data
OK
RING
RING
ATA
```

data channel is ON

3.14. TTY Feature

Refer to document [18].

3.15. Software Shutdown

Enter the following AT command to start the module shutdown.

```
AT#SHDN
OK
```

During shutdown, the module executes the following actions:

- Detachment from the network
- Module power off

To have more information about procedure and timing refer to document [3] in accordance with the module that you are using.

4. ADVANCED AT COMMANDS

4.1. Call Management

4.1.1. Identifying the Call Type

The module can identify the call type before answering. To accomplish this feature, the module provides different ring indications (URC) depending on the call type. It is up to the user to enable the extended format reporting of incoming calls using the following AT command.

```
AT+CRC=[<mode>]
OK
```

Examples

Disable extended format reporting, and then assume that the module receives a call.

```
AT+CRC=? ← Check the range value
+CRC: (0,1)
OK
```

```
AT+CRC=0 ← Disable extended format reporting.
OK
```

```
AT+CRC?
+CRC: 0
OK
```

The module detects a call. Ring indications are displayed on DTE:

```
RING
RING
```

Now, enable extended format reporting, and then assume the module receives a call.

```
AT+CRC=1 ← Enable extended format reporting
OK
```

```
AT+CRC? ← Check if extended format reporting is enabled
+CRC: 1
OK
```

The module detects a call. Ring indications in extended format are displayed on DTE:

```
+CRING: VOICE
+CRING: VOICE
```

4.1.2. Identify the Caller

The Telit Module can identify the caller number and give indication about it before the call is answered. The Calling Line Indication is shown on DTE after each RING or +CRING indication. The following AT command is used to enable/disable the Calling Line Indication.

```
AT+CLIP=[<n>]
OK
```

Examples

Enable extended format reporting and caller number identification, and then assume to receive a call.

Enable extended format reporting.

```
AT+CRG=1
OK
```

Check if extended format reporting is enabled.

```
AT+CRG?
+CRG: 1
OK
```

Check the values range.

```
AT+CLIP?
+CLIP: 0,1
OK
```

Enable caller number identification.

```
AT+CLIP=1
OK
```

```
AT+CLIP?
+CLIP: 1,1
OK
```

The module detects a call; ring indications and Calling Line Identification of the calling party are displayed on DTE:

```
+CRING: VOICE
+CLIP: "+390404X92XYX",145,"",128,"",0
+CRING: VOICE
+CLIP: "+390404X92XYX",145,"",128,"",0
```

4.1.3. Calling Line Indication

The Telit Module can send the Calling Line Indication (CLI) to the other party through the Network when an outgoing call is established. This indication can be restricted (CLIR) in various ways.

4.1.3.1. CLIR Service Status

Use the following AT command to query the CLIR Service status.

```
AT+CLIR?
```

Examples

Check the current CLIR settings:

```
AT+CLIR?
+CLIR: 0,4
OK
```

<n> = 0 = CLIR module facility in accordance with CLIR Network Service

<m>= 4 = CLIR temporary mode presentation allowed (it is the facility status on the Network)

The <m> parameter reports the status of the service at Network level. If the CLIR service is not provisioned by the Network, then it is not possible to use this service and changing the first parameter <n> will not change the CLI presentation to the other party behavior of the Network.

4.1.3.2. Restrict/Allow Caller Line ID Indication

Use the following AT command to enable or disable the presentation of the CLI to the called party.

```
AT+CLIR=<n>
OK
```

Examples

Disable the CLI presentation to the other party permanently.

Read the supported values.

```
AT+CLIR=?
+CLIR: (0-2)
OK
```

Read the current Module and Network status.

```
AT+CLIR?
+CLIR: 0,4
OK
```

Set to 1 Module status, CLI not sent.

```
AT+CLIR=1
OK
```

Read the current Module and Network status.

```
AT+CLIR?
+CLIR: 1,4
OK
```

4.1.4. Call Barring Control

The Call Barring Service enables the user to control the calls. The user can block all:

- Outgoing calls
- Outgoing international calls
- Outgoing international calls except those for its Country

- Incoming calls
- Incoming calls while roaming.

User can activate or cancel Call Barring using the AT commands hereafter described. Moreover, the user needs to enter a special access code (Call Barring Access Code) to modify Call Barring options. Network Operator provides the Call Barring Code for every subscriber. Hereafter the Call Barring Code is indicated as "Network Password provided by Network Operator".

The network handles the Call Barring Service, hence the module sends a network request and it may take several seconds to have the response from the network. Furthermore, all the Call Barring Service AT commands must be used when the module is registered on some network, otherwise an error code is returned.

4.1.4.1. Lock/Unlock the Module

Use the following AT command to lock/unlock the Module or a Network facilities:

AT+CLCK=<fac>,<mode>[,<passwd>[,<class>]]

4.1.4.1.1. 2G Modules

Read the supported facilities:

AT+CLCK=?

+CLCK: ("SC","FD","AO","OI","OX","AI","IR","AB","AG","AC","PN","PU","PP","PC","PS","PF")
OK

4.1.4.1.2. 3G Modules

Read the supported facilities:

AT+CLCK=?

+CLCK: ("SC","FD","AO","OI","OX","AI","IR","AB","AG","AC","PN","PU","PP","PC","PS","PF","MC")
OK

4.1.4.2. Call Barring Service Status

Use the following AT command to require the status of the selected network facility.

AT+CLCK=<fac>,2

Examples

Check the status of SIM facility:

```
AT+CLCK="SC",2  
+CLCK: 1  
OK
```

Check the status of a wrong facility just to see the format response. Before doing that verify the Extended Error result code.

```
AT+CMEE?  
+CMEE: 2 ← verbose format  
OK
```

```
AT+CLCK="S1",2  
+CME ERROR: operation not supported
```

Check "IR" network facility status (Bar Incoming Calls status when roaming outside the home country).

```
AT+CLCK=IR,2  
+CLCK: 0,1  
+CLCK: 0,2  
+CLCK: 0,4  
OK
```

"IR" network facility is unlocked (0): 1 = voice, 2 = data, 4 = fax.

Check "OI" network facility status (Bar Outgoing (originated) International Calls).

```
AT+CLCK=OI,2  
+CLCK: 0,1  
+CLCK: 0,2  
+CLCK: 0,4  
OK
```

"OI" network facility is unlocked (0): 1 = voice, 2 = data, 4 = fax.

Assume that the module is not registered. Try to check "OI" network facility status just to see the format response when Extended Error result code is enabled in numeric format.

```
AT+CMEE=1  
OK  
  
AT+CLCK=OI,2  
+CME ERROR: 100
```

4.1.4.3. Bar/Unbar All Incoming Calls

Use the following AT command to change the status of the AI network facility (All Incoming Calls):

AT+CLCK=AI,<mode>,<passwd>

Examples

Lock and unlock "AI" network facility. Assume that the Network Password provided by Network Operator is 2121.

Check "AI" network facility status:

AT+CLCK=AI,2

+CLCK: 0,1

+CLCK: 0,2

+CLCK: 0,4

OK

"AI" network facility is unlocked (0): 1 = voice, 2 = data, 4 = fax.

Lock "AI" network facility:

AT+CLCK=AI,1,2121

OK

Check "AI" facilities status:

AT+CLCK=AI,2

+CLCK: 1,8

+CLCK: 1,4

+CLCK: 1,2

OK

"AI" network facility is locked (1): 8 = short message service, 4 = fax, 2 = data.

Unlock "AI" facilities:

AT+CLCK=AI,0,2121

OK

Check "AI" facilities status:

AT+CLCK=AI,2

+CLCK: 0,1

+CLCK: 0,2

+CLCK: 0,4

OK

"AI" network facility is unlocked (0): 1 = voice, 2 = data, 4 = fax.

4.1.4.4. Bar/Unbar Incoming Calls in International Roaming

Use the following AT command to change the status of the “IR” network facility (Incoming Calls when Roaming outside the home country).

AT+CLCK=IR,<mode>,<passwd>

Examples

Lock and unlock “IR” network facility. Assume that the network password provided by Network Operator is 2121.

Check “IR” network facilities status:

```
AT+CLCK=IR,2  
+CLCK: 0,1  
+CLCK: 0,2  
+CLCK: 0,4  
OK
```

“IR” network facility is unlocked (0): 1 = voice, 2 = data, 4 = fax.

Lock “IR” network facility:

```
AT+CLCK=IR,1,2121  
OK
```

Check “IR” facilities status:

```
AT+CLCK=IR,2  
+CLCK: 1,1  
+CLCK: 1,8  
+CLCK: 1,4  
+CLCK: 1,2  
OK
```

“IR” network facility is locked (1): 8 = short message service, 4 = fax, 2 = data.

Unlock “IR” network facility:

```
AT+CLCK=IR,0,2121  
OK
```

Read IR facilities status:

```
AT+CLCK=IR,2  
+CLCK: 0,1  
+CLCK: 0,2  
+CLCK: 0,4  
OK
```

“IR” network facility is unlocked (0): 1 = voice, 2 = data, 4 = fax.

4.1.4.5. Bar/Unbar All Outgoing Calls

Use the following AT command to change the status of the “AO” network facility (All Outgoing Calls).

AT+CLCK=AO,<mode>,<passwd>

Examples

Lock and unlock “AO” network facility. Assume the network password provided by Network Operator is 2121.

Check “AO” network facility status:

AT+CLCK=AO,2

+CLCK: 0,1

+CLCK: 0,2

+CLCK: 0,4

OK

“AO” network facility is unlocked (0): 1 = voice, 2 = data, 4 = fax.

Lock “AO” network facility:

AT+CLCK=AO,1,2121

OK

Check “AO” network facility status:

AT+CLCK=AO,2

+CLCK: 1,8

+CLCK: 1,4

+CLCK: 1,2

OK

“AO” network facility is locked (1): 8 = short message service, 4 = fax, 2 = data.

Unlock “AO” network facility:

AT+CLCK=AO,0,2121

OK

Checking “AO” network facility status:

AT+CLCK=AO,2

+CLCK: 0,1

+CLCK: 0,2

+CLCK: 0,4

OK

“AO” network facility is unlocked (0): 1 = voice, 2 = data, 4 = fax.

4.1.4.6. Bar/Unbar All Outgoing International Calls

Use the following AT command to change the status of the “OI” network facility (Outgoing International Calls).

AT+CLCK=OI,<mode>,<passwd>

Examples

Lock and unlock “OI” network facility. Assume the network password provided by Network Operator is 2121.

Checking “OI” network facility status:

```
AT+CLCK=OI,2  
+CLCK: 0,1  
+CLCK: 0,2  
+CLCK: 0,4  
OK
```

“OI” network facility is unlocked (0): 1 = voice, 2 = data, 4 = fax.

Lock “OI” network facility:

```
AT+CLCK=OI,1,2121  
OK
```

Check “OI” network facility status:

```
AT+CLCK=OI,2  
+CLCK: 1,1  
+CLCK: 1,8  
+CLCK: 1,4  
+CLCK: 1,2  
OK
```

“OI” network facility is locked (1): 1 = voice, 8 = short message service, 4 = fax, 2 = data.

Unlock “OI” network facility:

```
AT+CLCK=OI,0,2121  
OK
```

Check “OI” network facility status:

```
AT+CLCK=OI,2  
+CLCK: 0,1  
+CLCK: 0,2  
+CLCK: 0,4  
OK
```

“OI” network facility is unlocked (0): 1 = voice, 2 = data, 4 = fax.

4.1.4.7. Bar/Unbar All Outgoing Internat. Calls except to Home Country

Use the following AT command to change the status of the "OX" network facility (Outgoing International Calls except to Home Country).

AT+CLCK=OX,<mode>,<passwd>

Examples

Lock and unlock "OX" network facility. Assume the network password provided by Network Operator is 2121.

Check "OX" network facility status:

AT+CLCK=OX,2

+CLCK: 0,1

+CLCK: 0,2

+CLCK: 0,4

OK

"OX" network facility is unlocked (0): 1 = voice, 2 = data, 4 = fax.

Lock "OX" network facility. It is a setting not supported by the network:

AT+CLCK=OX,1,2121

ERROR

Enable extended error result codes in verbose format:

AT+CMEE=2

OK

Try again to lock "OX" network facility:

AT+CLCK=OX,1,2121

+CME ERROR: unknown

Check "OX" network facility status:

AT+CLCK=OX,2

+CLCK: 0,1

+CLCK: 0,2

+CLCK: 0,4

OK

"OX" network facility is unlocked (0): 1 = voice, 2 = data, 4 = fax.

4.1.4.8. Unbar All Calls

Use the following AT command to unlock “AB” network facility (All Barring services).

AT+CLCK=AB,0,<passwd>

Examples

Unlock “AB” network facility. Assume the Network Password provided by Network Operator is 2121.

AT+CLCK=AB,0,2121
OK

Check “IR” network facility status:

AT+CLCK=IR,2
+CLCK: 0,1
+CLCK: 0,2
+CLCK: 0,4
OK

“IR” network facility is unlocked (0): 1 = voice, 2 = data, 4 = fax.

Check “OI” network facility status:

AT+CLCK=OI,2
+CLCK: 0,1
+CLCK: 0,2
+CLCK: 0,4
OK

“OI” network facility is unlocked (0): 1 = voice, 2 = data, 4 = fax.

Check “AI” network facility status:

AT+CLCK=AI,2
+CLCK: 0,1
+CLCK: 0,2
+CLCK: 0,4
OK

“AI” network facility is unlocked (0): 1 = voice, 2 = data, 4 = fax.

4.2. DTMF Tones

Refer to document [18].

4.3. Encryption Algorithm

Use the following AT command to enables or disables the GSM and/or GPRS encryption algorithms supported by the module.

AT#ENCALG=[<encGSM>][,<encGPRS>]

In accordance with the response of the AT#ENCALG=? Command, you can know the features supported by the command and your Telit Module type.

4.3.1. 2G Modules

AT#ENCALG=?
 #ENCALG: (0,1,4,5,255),(0-3,255)
 OK

4.3.2. 3G Modules

AT#ENCALG=?
 #ENCALG: (0,1,4,5,255),(0-7,255)
 OK

Examples

AT#ENCALG=? ← Get the supported parameters range
 #ENCALG: (0,1,4,5,255),(0-3,255)
 OK

AT#ENCALG? ← Get the current setting
 #ENCALG: 5,3,1,0
 OK

Selected: 5 = A5/1 or A5/3; 3 = GEA1 or GEA2
 Last used: 1 = A5/1; 0 = no GPRS algorithm

AT#ENCALG=0,3 ← no GSM algorithm
 OK

AT#ENCALG? ← Setting is not changed
 #ENCALG: 5,3,1,0
 OK

Turn OFF/ON the module

```
AT#ENCALG?           ← Setting is changed!
#ENCALG: 0,3,0,0
OK
```

4.4. SMS Management

The modules provide the SMS Service to store, send, receive, and delete a SMS, which is a short text message up to 160 characters long. Before using the SMS messages, you must configure the Short Message Service.

4.4.1. Select SMS Format Type

The Telit Module supports two SMS formats:

- PDU mode
- Text mode

The module uses the PDU format to send a message on the air. The PDU mode enables the user to edit the message in PDU format. If the user is familiar with PDU encoding, he can operate with PDU by selecting that mode and use the appropriate commands.

The present document uses the Text mode to explain how to operate with SMS. Here is the AT command to select the mode.

```
AT+CMGF=<mode>
```

Examples

Check the supported range of values:

```
AT+CMGF=?
+CMGF: (0,1)
OK
```

Set up Text Mode for the SMS:

```
AT+CMGF=1
OK
```

This setting is stored and remains active until the module is turned OFF.

4.4.1.1. Set Text Mode Parameters

When SMS format is Text mode, the SMS parameters that usually reside on the header of the PDU must be set apart with the +CSMP command.

```
AT+CSMP=<fo>,<vp>,<pid>,<dc>
```

Example 1

Set the SMS parameters as follow:

- <fo> expressed in binary format, see table below. The binary number expressed in decimal format is 17.

0	0	0	1	0	0	0	1
Module is not requesting a status report	Always 0	Replay Path not requested	Validity period field present in relative format	Always 0	SMS-SUBMIT		

- <vp> validity period (in relative format) = 24 hours is coded into 167 decimal format.
- <pid> protocol identifier.
- <dc> data coding scheme, default value 0.

AT+CSMP= 17,167,0,0

OK

Example 2

Set the SMS parameters as follow:

- <fo> expressed in binary format, see table below. The binary number expressed in decimal format is 25.

0	0	0	1	1	0	0	1
Module is not requesting a status report	Always 0	Replay Path not requested	Validity period field present in absolute format	Always 0	SMS-SUBMIT		

- <vp> validity period in absolute format represents the expiration date of the message, for example:
date: 29/06/02; time: 02:20; in the time zone of Italy (+1) is formatted as follows:
"29/06/02,02:20:00+1"
- <pid> protocol identifier.
- <dc> data coding scheme:
 - Default Alphabet
 - Class 0 (immediate display SMS)

Data coding scheme is coded in the following binary format: 11110000, corresponding to 240 in decimal format.

AT+CSMP= 25, 29/06/02,02:20:00+1,0,240

OK



Use dcs=0 if no particular data coding scheme is needed. Not all dcs combinations described in the [7] are jointly supported by Networks and Telit Modules: some features may be not implemented on Networks or on Telit Modules. This no matching is resulting in a +CMS ERROR: 303 result code (operation not supported), use different dcs.

4.4.1.2. Character Sets

Use the following AT command to select the character set:

AT+CSCS=<76hest>

Here are the supported character sets:

- "GSM" (default alphabet, [7])
- "IRA" – ITU-T.50
- "8859-1" – ISO 8859 Latin 1
- "PCCP437" – PC character set Code Page 437.
- "UCS2" – 16-bit universal multiple-octet coded character set (ISO/IEC10646)

Examples

Check the supported character sets:

```
AT+CSCS=?
+CSCS: ("GSM","IRA","8859-1","PCCP437","UCS2")
OK
```

Check the current character set:

```
AT+CSCS?
+CSCS: "IRA"
OK
```

Select a non-existent character set, merely to see the response format:

```
AT+CSCS="GSA"
ERROR
```

Enabling the Error report in verbose format:

```
AT+CMEE=2
OK
```

Select again a non-existent character set:

```
AT+CSCS="GSA"
+CME ERROR: operation not supported
```

4.4.1.2.1. IRA Character Set

The IRA character set is used in Text mode. IRA set defines each character as a 7-bit value: from 0x00 to 0x7F. The table below lists all the supported characters and their hexadecimal code.

		Most Significant Nibble							
		0x	1x	2x	3x	4x	5x	6x	7x
Least Significant Nibble	x0			SP ¹	0	@	P		p
	x1			!	1	A	Q	a	q
	x2			"	2	B	R	b	r
	x3			#	3	C	S	c	s
	x4			\$	4	D	T	d	t
	x5			%	5	E	U	e	u
	x6			&	6	F	V	f	v
	x7			'	7	G	W	g	w
	x8			(8	H	X	h	x
	x9)	9	I	Y	i	y
	xA	LF ²		*	:	J	Z	j	z
	xB			+	;	K		k	
	xC			,	<	L		l	
	xD	CR ³		-	=	M		m	
	xE			.	>	N		n	
	xF			/	?	O	£	o	

¹ – SP stands for space character

² – LF stands for Line Feed character

³ – CR stands for Carriage Return character

The following examples show how to use the IRA table:

- Get the IRA code of the character '&': the most significant nibble is 2, the least significant nibble is 6, so the IRA code for the '&' character is the hexadecimal value: 0x26.
- Translate IRA code 0x6B into the corresponding character: the most significant nibble is 6, the least significant nibble is B, the cell at the crossing of column 6 and row B holds the character: "k".

4.4.1.2.2. UCS2 Character Set

The UCS2 Character Set is used in Text mode.

- Phone number 329 05 69 6... converted into "UCS2" format: 3=0033, 2=0032, 9=0039, 0=0030, 5=0035, 6=0036, 9=0039, 6=0036 ...
- Text HELLO converted into UCS2 format: H=0048, E=0045, L=004C, O=004F

4.4.2. Read SMSC Number

The module sends the SMS to the SMSC where the message is dispatched towards its final destination or is kept until the delivery is possible. To ensure the correct operation of this service the number of the SMSC needs to be configured on the module in accordance with the network operator used.

To know the SMSC number stored on the module, use the following AT command.

AT+CSCA?

Check the stored SMSC number:

AT+CSCA?

+CSCA: "+39X20XX58XX0",145

OK

SMSC number is compliant with the international numbering scheme.

4.4.3. Set SMSC Number

Use the following AT command to store a new SMSC number. The old number is overwritten.

AT+CSCA=<number>,<type>

Set up the desired SMSC number in international format:

AT+CSCA=+39X20XX58XX0,145

OK

This setting remains stored in the SIM card until it is changed or deleted, so this operation may be done only once if the SIM Card is not changed.

Enter the command with no SMSC number:

AT+CSCA=,145

OK

Check the stored SMSC number:

AT+CSCA?

+CSCA: "+",145

OK

Enable extended result code in verbose format:

AT+CMEE=2

OK

Enter the command with no parameters:

AT+CSCA=

ERROR

4.4.4. Send a SMS

Use the following AT command to send a SMS.

AT+CMGS



To read and set the SMSC number see § 4.4.2 and 4.4.3.

4.4.4.1. 2G Modules

Example 1

Send a SMS to the module itself and do not store it. Use the UCS2 character set.

Select Text Mode.

AT+CMGF=1

OK

Check the SMS operation mode provided by the module.

AT#SMSMODE=?

#SMSMODE: (0-2)

OK



Telit does not suggest to disable the improved SMS operation mode (ETSI Standard compliant). AT#SMSMODE command is provided to resolve retro compatibility issues.

AT#SMSMODE=0

OK

Select the UCS2 character set.

AT+CSCS="UCS2"
OK

Set SMS parameters:

AT+CSMP=17,168,0,26
OK

Select how the new received message event is notified by the DCE to the DTE.

AT+CNMI=1,1,0,0,0
OK

Send the message to the module itself. The UCS2 character set is used:

- Phone number 329 05 69 628 is converted into "UCS2" format: 3=0033, 2=0032, 9=0039, 0=0030, 5=0035, 6=0036, 9=0039, 6=0036, 2=0032, 8=0038
- Text CIAO is converted into UCS2 format: C=0043, I=0049, A=0041, O=004F

AT+CMGS=0033003200390030003500360039003600320038
> **004300490041004F** (close the message with Ctrl Z)
+CMGS: 81
OK

The module itself receives the SMS, the following unsolicited indication is shown on DTE:

+CMTI: "SM",3



The SMS was successfully sent to the SMSC and its network reference number is 81. Do not confuse message reference with message index position: the first one indicates the network reference for identifying the sent message, the second one – reported by the unsolicited indication – indicates that the module receives the message and it is stored on the position 3 of the "SM" storage.

Select the "SM" storage as indicated by the unsolicited indication.

AT+CPMS="SM"
+CPMS: 3,50,3,50,3,50
OK

Read the message from the storage position indicated by the unsolicited indication.

AT+CMGR=3
+CMGR: "REC UNREAD", "002B003300390033003200390030003500360039003600320038",
"00570049004E0044002000530049004D", "08/05/13,12:22:08+08"
004300490041004F
OK

Example 2

Send a SMS to the module itself and do not store it.

Select Text Mode

```
AT+CMGF=1
OK
```



Telit suggest to enable the improved SMS operation mode.

```
AT#SMSMODE=1
OK
```

Select how the new received message event is notified by the DCE to the DTE.

```
AT+CNMI=1,1,0,0,0
OK
```

Send the message to the module itself.

```
AT+CMGS="+39329X569YYY"
> SEND THE SMS #1 TO ITSELF (close the message with Ctrl Z)
+CMGS: 76
OK
```

The module itself receives the SMS #1, the following unsolicited indication is shown on DTE:

```
+CMTI: "SM",1
```

The SMS was successfully sent to the SMSC and its network reference number is 76. Do not confuse message reference with message index position: the first one indicates the network reference for identifying the sent message, the second one – reported by the unsolicited indication – indicates that the module has received the message and it is stored on the position 1 of the "SM" storage.

Use unsolicited indication parameter to read the SMS #1 for the first time.

```
AT+CMGR=1
+CMGR: "REC UNREAD", "+39329X569YYY", "WIND SIM", "08/04/18,13:58:04+08"
SEND THE SMS #1 TO THE MODULE ITSELF
OK
```

4.4.4.2. 3G Modules

The 3G modules series supports only the improved SMS feature, accordingly the AT#SMSMODE command is not supported by this series.

4.4.5. Select/Check SMS Storage Type

Telit Modules can provide two type of SMS storage, in agreement with the family of belonging:

- “SM” – SIM Card Memory
- “ME” – Mobile Equipment Memory.

Use the following AT command to select memory storage:

AT+CPMS=<memr>,<memw>,<mems>

4.4.5.1. 2G Modules

These modules have two storage types: "SM" and "ME". The modules provide the AT#SMSMODE command to enable/disable the improved SMS feature that are ETSI Standard compliant.

Example 1

AT#SMSMODE?	← Check the SMS mode
#SMSMODE: 1	← Improved SMS functionality are enabled
OK	
AT+CPMS=?	← Check the supported SMS storage types
+CPMS: ("SM"),("SM"),("SM")	← Only "SM" storage type is supported
OK	

Example 2

AT#SMSMODE=0	← Disable improved SMS functionality
#SMSMODE: 0	
OK	
AT#SMSMODE?	← Check SMS mode
#SMSMODE: 0	
OK	
AT+CPMS=?	← Check the supported SMS storage types
+CPMS: ("ME", "SM"), ("SM"), ("SM")	
OK	
AT+CPMS?	← Check the current active storage type
+CPMS: "SM",1,50,"SM",1,50,"SM",1,50	
OK	

AT+CPMS="ME" ← Select "ME" storage type
 +CPMS: 1,1,1,50,1,50
 OK

AT+CPMS? ← Check the current active storage types
 +CPMS: "ME",1,1,"SM",1,50,"SM",1,50 ← Two SMS storage types are active: "ME"
 OK and "SM"

The "ME" storage is a volatile read only memory, where only one received message of Class 0 can be stored regardless of the selected storage, which could be "SM".

4.4.5.2. 3G Modules

These modules provide only the improved SMS features, therefore the #SMSMODE command is not needed.

AT+CPMS=? ← Check the supported SMS storage types
 +CPMS: ("SM"),("SM"),("SM") ← Only "SM" storage type is supported
 OK

4.4.6. Select URC Behavior

When the module receives a new SMS, an Unsolicited Result Code is generated. This indication may be sent to the DTE, buffered if the DTE is busy (for example, during a data call), or discarded. To set the desired behavior, use the following command:

AT+CNMI=<mode>,<mt>,<bm>,<ds>,<bfr>

4.4.6.1. 2G Modules

Example

Assume that the module sends two consecutive SMSs to itself to see the unsolicited indications on DTE and verify that "ME" provides a single storage position. In fact, the second SMS overlaps the first one. Here is the AT commands sequence.

AT+CMGF=1 ← Select Text Mode
 OK

AT#SMSMODE=0 ← Disable SMS improved functionality
 OK

AT+CSMP=17,168,0,240 ← Set up Class 0
 OK

Select how the module notifies to the DTE the receiving of a new message from the network.

AT+CNMI=1,1,0,0,0
 OK

Send the message to the module itself

AT+CMGS="+39329X569YYY"

> SEND THE SMS #1 TO MODULE ITSELF (close the message with Ctrl Z)

+CMGS: 76

OK

The module itself receives the SMS #1, the following unsolicited indication is shown on DTE:

+CMTI: "ME",1

AT+CPMS="ME" ← Select SMS storage type

+CPMS: 1,1,13,50,13,50

OK

Use unsolicited indication parameter to read the SMS #1 for the first time.

AT+CMGR=1

+CMGR: "REC UNREAD", "+39329X569YYY", "WIND SIM", "08/04/18,13:58:04+08"

SEND THE SMS #1 TO MODULE ITSELF

OK

Read again the SMS # 1 to see the "REC READ" status.

AT+CMGR=1

+CMGR: "REC READ", "+39329X569YYY", "WIND SIM", "08/04/18,13:58:04+08"

SEND THE SMS #1 TO MODULE ITSELF

OK

Check the current active storage types.

AT+CPMS?

+CPMS: "ME",1,1,"SM",13,50,"SM",13,50

OK

Send the second message to the module itself:

AT+CMGS="+39329X569YYY"

> SEND THE SMS #2 TO THE MODULE ITSELF (close the message with Ctrl Z)

+CMGS: 77

OK

The module itself receives the SMS #2, the following unsolicited indication is shown on DTE:

+CMTI: "ME",1

Use unsolicited indication parameter to read the just received SMS.

AT+CMGR=1

+CMGR: "REC UNREAD", "+39329X569YYY", "WIND SIM", "08/04/18,14:47:23+08"

SEND THE SMS #2 TO MODULE ITSELF

OK

The new SMS has overlapped the old one.

4.4.6.2. 3G Modules

These modules provide only the improved SMS feature; therefore, the #SMSMODE command is not needed.

4.4.7. Store a SMS

Use the following AT command to store a SMS.

AT+CMGW="<da>"

4.4.7.1. 2G Modules

Example

Store a new SMS in the "SM" storage, send it to the module itself and read the message in the receiving storage.

AT+CMGF=1 ← Select Text Mode
OK

AT#SMSMODE=0 ← Disable the improved SMS functionality
OK

AT+CSMP=17,168,0,240 ← Assume to send a SMS of Class 0
OK

Select how the new received message event is notified by the DCE to the DTE

AT+CNMI=1,1,0,0,0
OK

Store into "SM" the SMS message to be sent to the module itself.

AT+CMGW="+39329X569YYY"
> **SEND THE STORED SMS #1 TO THE MODULE ITSELF** (close with Ctrl Z or ESC to abort)
+CMGW: 1
OK

Send the stored SMS #1 using the storage position returned by the previous command.

AT+CMSS=1
+CMSS: 78
OK

The module itself receives the SMS #1, the following unsolicited indication is shown on DTE:

+CMTI: "ME",1

Check the current storage memory for SMS reading.

AT+CPMS?

```
+CPMS: "SM",1,50,"SM",1,50,"SM",1,50
OK
```

Use index 1 to read SMS #1 from "SM" storage memory, where the SMS was stored before sending.

AT+CMGR=1

```
+CMGR: "STO SENT","+39329X569YYY","WIND SIM"
SEND THE STORED SMS # 1 TO MODULE ITSELF
OK
```

Select "ME" storage type.

AT+CPMS="ME"

```
+CPMS: 1,1,1,50,1,50
OK
```

Use index 1 to read received SMS #1 from "ME" storage type.

AT+CMGR=1

```
+CMGR: "REC UNREAD","+39329X569YYY","WIND SIM","08/04/21,09:56:38+08"
SEND THE STORED SMS # 1 TO THE MODULE ITSELF
OK
```

Use index 1 to read again received SMS #1 from "ME".

AT+CMGR=1

```
+CMGR: "REC READ","+39329X569YYY","WIND SIM","08/04/21,09:56:38+08"
SEND THE STORED SMS # 1 TO THE MODULE ITSELF
OK
```

4.4.7.2. 3G Modules

Example

Store a SMS in the "SM" storage, send it to the module itself and read the message in the receiving storage.

```
AT+CMGF=1
OK
```

← Select Text Mode

```
AT+CSMP=17,168,0,240
OK
```

← Assume to send a SMS of Class 0

Select how the new received message event is notified by the DCE to the DTE

```
AT+CNMI=1,1,0,0,0
OK
```

Store into "SM" the SMS message to be sent to the module itself.

```
AT+CMGW="+39329X569YYY"
```

```
> SEND THE STORED SMS #1 TO THE MODULE ITSELF (close with Ctrl Z or ESC to abort)
```

```
+CMGW: 5
OK
```

Use index 5 to read SMS #1 from "SM" storage type.

```
AT+CMGR=5
+CMGR: "STO SENT", "+39329X569YYY", "WIND SIM"
SEND THE STORED SMS # 1 TO MODULE ITSELF
OK
```

Send the stored SMS #1 using the storage position 5 returned by the previous command.

```
AT+CMSS=5
+CMSS: 78
OK
```

The module itself receives the SMS #1, the following unsolicited indication is shown on DTE:

```
+CMTI: "SM",6
```

Check the current SMS storage type.

```
AT+CPMS?
+CPMS: "SM",6,30,"SM",6,30,"SM",6,30
OK
```

Use index 6 to read received SMS #1 from "SM" storage memory.

```
AT+CMGR=6
+CMGR: "REC UNREAD", "+39329X569YYY", "WIND SIM", "08/04/21,09:56:38+08"
SEND THE STORED SMS # 1 TO THE MODULE ITSELF
OK
```

Use index 6 to read again received SMS #1 from "SM" storage memory.

```
AT+CMGR=6
+CMGR: "REC READ", "+39329X569YYY", "WIND SIM", "08/04/21,09:56:38+08"
SEND THE STORED SMS # 1 TO THE MODULE ITSELF
OK
```

4.4.7.3. PDU Mode

AT+CMGW command does not work when the module is in PDU mode.

Example

```
AT+CMGF=0          ← Set up PDU Mode
OK
```

Store into "SM" storage the SMS message to be sent.

```
AT+CMGW="+39329X569YYY"
+CMS ERROR: 304      ← the command does not work when the module is in PDU Mode.
```

Set up Text Mode.

```
AT+CMGF=1
OK
```

Store into "SM" storage the SMS message to be sent.

```

AT+CMGW="+39329X569YYY"
> EDIT NEW SMS ... (use ESC to abort the command.)
OK

```

4.4.8. Send a Stored SMS

A SMS stored in the "SM" storage type is sent using the following AT command. Its storage location index is needed.

```

AT+CMSS=<index>

```



If the module belongs to one of the 2G series, you must use AT#SMSMODE=1

Example

Send the stored SMS to the module itself:

Select Text Mode

```

AT+CMGF=1
OK

```

Select "SM" storage to read SMS

```

AT+CPMS="SM"
+CPMS: 1,50,1,50,1,50
OK

```

Read the SMS stored on position 1.

```

AT+CMGR=1
+CMGR: "STO SENT", "+39329X569YYY", "WIND SIM"
SEND THE STORED SMS # 1 TO MODULE ITSELF
OK

```

Select how the new received message event is indicated by the DCE to the DTE.

```

AT+CNMI=1,1,0,0,0
OK

```

Send the stored SMS # 1 message to module itself.

```

AT+CMSS=1
+CMSS: 79
OK

```

The module itself receives the SMS #1, the following unsolicited indication is shown on DTE:

```

+CMTI: "SM",2

```

4.4.9. Send a New SMS using GPRS service

An SMS can be sent by means of the GPRS service [4]. It is worth to remind that not all Network Operators support this features.



If the module belongs to one of the 2G series, you must use AT#SMSMODE=1

Example

Send the SMS message to the module itself, not store it before transmitting and use the GPRS service.

AT#SELINT=2 ← Select AT command interface style
OK

AT+CGSMS=2 ← Select the GPRS service
OK

Check if the module is attached to GPRS service

AT+CGATT?
+CGATT: 1
OK

Select Text Mode.

AT+CMGF=1
OK

Select how the new received message event is indicated by the DCE to the DTE.

AT+CNMI=1,1,0,0,0
OK

Send the message to the module itself.

AT+CMGS="+386X18X19X4"
> **SEND THE SMS BY MEANS OF THE GPRS SERVICE TO ITSELF** (close the message with Ctrl Z)
+CMGS: 14
OK

The module itself receives the SMS, the following unsolicited indication is shown on DTE:

+CMTI: "SM",11

AT+CPMS="SM"
+CPMS: 11,50,11,50,11,50
OK

Use unsolicited indication parameter to read the SMS for the first time.

AT+CMGR=11
+CMGR: "REC UNREAD","+386X18X19X4","","09/08/03,14:14:04+08"
SEND THE SMS BY MEANS OF THE GPRS SERVICE TO ITSELF
OK

4.4.10. Delete an SMS

Use the following AT command to delete an SMS stored on the "SM" storage type.

AT+CMGD=<index>*Example*

Deleting an SMS stored in “SM” storage type:

AT+CPMS="SM" ← Select memory storage
 +CPMS: 13,50,13,50,13,50
 OK

AT+CMGD=? ← Check the SMS
 +CMGD: (1,2,3,4,5,6,7,8,9,10,11,12,13),(0-4)
 OK

Delete SMS in memory position 1.

AT+CMGD=1
 OK

Check if the SMS is deleted:

AT+CMGD=?
 +CMGD: (2,3,4,5,6,7,8,9,10,11,12,13),(0-4)
 OK

Delete all SMS. Disregard the first parameter of the +CMGD.

AT+CMGD=1,4
 OK

AT+CMGD=?
 +CMGD: (),(0-4)
 OK

4.4.10.1. 2G Modules

AT#SMSMODE=0
 OK

AT+CPMS="ME" ← Select “ME” storage type
 +CPMS: 1,1,6,30,6,30
 OK

AT+CMGD=? ← Check the SMS.
 +CMGD: (1),(0-4)
 OK

AT+CMGD=1 ← Delete SMS in storage position 1
 OK

Check if the SMS is deleted.

```
AT+CMGD=?
+CMGD: (),(0-4)
OK
```

4.4.11. Read an SMS

An SMS is read with the following command:

```
AT+CMGR=<index>
```

Example

```
AT+CPMS?
+CPMS: "SM",1,50,"SM",1,50,"SM",1,50
OK
```

Read the SMS #1, for the first time, in storage memory "SM", position 1:

```
AT+CMGR=1
+CMGR: "STO SENT","+39329X569YYY","WIND SIM"
SEND THE STORED SMS # 1 TO MODULE ITSELF
OK
```

4.4.12. SMS Status

SMSs can be gathered into 5 different groups depending on their Status:

- REC UNREAD: received messages still not read
- REC READ: received messages already read
- STO UNSENT: written messages not yet sent
- STO SENT: written messages already sent
- ALL: all types of messages

Use the following AT command to query the SMS status:

```
AT+CMGL=<stat>
```

Check if Text Mode is active

```
AT+CMGF?
+CMGF: 1 ← Text Mode is active
OK
```

Check the supported SMS status

```
AT+CMGL=?
+CMGL: ("REC UNREAD","REC READ","STO UNSENT","STO SENT","ALL")
OK
```

Check the available SMS storage type

AT+CPMS?

+CPMS: "SM",6,30,"SM",6,30,"SM",6,30
OK

List all the SMSs stored on "SM" storage with their Status.

AT+CMGL="ALL"

+CMGL: 1,"REC READ", SMS body
+CMGL: 2,"REC READ", SMS body
+CMGL: 3,"REC READ", SMS body
+CMGL: 4,"STO SENT", SMS body
+CMGL: 5,"STO SENT", SMS body
+CMGL: 6,"REC READ", SMS body
OK

List the SMSs stored on "SM" storage with their Status=STO SENT

AT+CMGL="STO SENT"

+CMGL: 4,"STO SENT", SMS body
+CMGL: 5,"STO SENT", SMS body
OK

4.4.12.1. 2G Modules

AT#SMSMODE=0

OK

Check the supported storage types

AT+CPMS=?

+CPMS:"ME","SM"),("SM"),("SM")
OK

Check if Text Mode is active.

AT+CMGF?

+CMGF: 1
OK

Check the supported SMS status.

AT+CMGL=?

+CMGL: ("REC UNREAD","REC READ","STO UNSENT","STO SENT","ALL")
OK

Select "ME" storage type.

AT+CPMS="ME"

+CPMS: 1,1,1,50,1,50
OK

List SMSs stored in the "ME" storage type.

AT+CMGL="ALL"

+CMGL: 1,"REC READ", SMS body
OK

AT+CMGL="REC UNREAD"

OK

4.4.13. Cell Broadcast Service

GSM Standard specifies two different types of SMS:

- SMS Point to Point (SMS/PP),
- SMS Cell Broadcast (SMS/CB).

The first type can send a text message long up to 160 characters from a module to the another (as stated on the previous paragraphs), the second type allows the Network to send, at the same time, a message to all modules contained in the defined area including one or more radio cells. The availability and the implementation of the Cell Broadcast Service are strictly connected with the Network Operator of the subscriber.

Use the following AT command to enable the Cell Broadcast Service:

AT+CSCB=[<mode>[,<mids>[,<dcss>]]]

Select Text Mode.

AT+CMGF=1

OK

Select the District service.

AT+CSCB=0,50,0

OK

Select how the new received message event is indicated by the DCE to the DTE.

AT+CNMI=2,0,2,0,0

OK

After a while the "District" broadcast message is displayed on the DTE.

+CBM: 24,50,1,1,1
TRIESTE

+CBM: 4120,50,2,1,1
TRIESTE

+CBM: 8216,50,1,1,1
TRIESTE

+CBM: 12312,50,2,1,1
TRIESTE

The network operator can provide the following list of Services, it is not mandatory:

<mids>	Service name
000	Index
010	Flashes
020	Hospitals
022	Doctors
024	Pharmacy
030	Long Distant Road Reports
032	Local Road Reports
034	Taxis
040	Weather
050	District
052	Network Information
054	Operator Services
056	Directory Inquiries (national)
057	Directory Inquiries (international)
058	Customer Care (national)
059	Customer Care (international)

4.4.14. Read concatenated SMS

Use the following AT command to read concatenated SMSs:

AT#CMGLCONCINDEX

Example

Check the number of stored SMSs

AT+CPMS?

+CPMS: "SM",6,30,"SM",6,30,"SM",6,30

OK

← 6 SMSs are stored.

Check if concatenated SMSs are stored

AT#CMGLCONCINDEX

OK

← No concatenated SMSs are stored

Set up Text Mode

AT+CMGF=1

OK

Set SMS parameters

AT+CSMP=17,167,0,242

OK

Store two concatenated SMSs (they are indicated with two colors):

4.5. Phonebooks

The user can access the different Phonebook types, stored on the SIM card or on the NVM memory, by means of the dedicated AT commands. The modules support the Phonebooks described in the following sub-chapters.

4.5.1. Phonebook types

The choice of the Phonebook type must be the first Phonebook operation. Once storage is selected, it is no longer needed to select it again until the desired storage remains the same, and the module is not turned off.

4.5.1.1. 2G Modules

- **“SM” – SIM Phonebook:** is used to store and recall phone numbers.
- **“FD” – SIM Fixed Dialing-Phonebook:** it is accessible by means of the PIN2 code. Example: if the “FD” storage holds the following string numbers 0432, 040, the module can call only phone numbers starting with one of the two string numbers.
- **“LD” – SIM/NVM Last-Dialing-Phonebook:** is the list of the last dialed phone numbers, it is updated automatically. +CPBW command can be only used to delete phone numbers.
- **“MC” – NVM Missed-Calls-Phonebook:** is the list of the received calls not answered. It is updated automatically. +CPBW command can be only used to delete phone numbers.
- **“RC” – NVM Received-Calls- Phonebook:** is the list of the received and answered calls. It is updated automatically. +CPBW command can be only used to delete phone numbers.
- **“MB” – SIM Mail-Box- Phonebook:** is a read only list of the phone mailbox numbers. The MB must be supported by SIM.

4.5.1.2. 3G Modules

- **“SM” – SIM Phonebook:** is used to store and recall phone numbers.
- **“FD” – SIM Fixed Dialing-Phonebook:** It is accessible by means of the PIN2 code. E.g.: if the “FD” storage holds the following string numbers 0432, 040, the module can call only phone numbers starting with one of the two string numbers.
- **“LD” –SIM Last-Dialing-Phonebook:** is the list of the last dialed phone numbers; it is updated automatically in SIM. +CPBW command can be only used to delete phone numbers.
- **“MC” – NVM Missed-Calls-Phonebook:** is the list of the received calls not answered. It is updated automatically. +CPBW command can be only used to delete phone numbers.
- **“RC” – NVM Received-Calls-List:** is the list of the received and answered calls. It is updated automatically. +CPBW command can be only used to delete phone numbers.
- **“MB” – SIM Mail-Box-List:** is a read only list of the phone mailbox numbers. The MB must be supported by SIM.
- **“DC” – NVM Last-Dialing-Phonebook:** is the list of the last dialed phone numbers stored on the module (NVM); it is updated automatically. +CPBW command can be only used to delete phone numbers.
- **“ME”- NVM Module Phonebook:** is used to store and recall phone numbers.
- **“EN”- SIM Emergency List:** is a read only list of the emergency phone numbers stored on SIM.
- **“ON”-SIM Own Number:** is the list of the SIM numbers, e.g.: SIM number for voice call and SIM number for data call.

4.5.2. Select Phonebook Memory Storage

Use the following AT command to select the Phonebook Memory Storage:

AT+CPBS=<storage>

4.5.2.1. 2G Modules

Examples

AT+CPBS=? ← Read the supported range of Phonebook Storages
 +CPBS: ("SM","FD","LD","MC","RC") ← "MB" is not supported by the inserted SIM
 OK

AT+CPBS? ← Read the current Phonebook Storage
 +CPBS: "SM",10,250
 OK

AT+CPBS="FD" ← Select "FD" phonebook storage
 ERROR

AT+CMEE=2
 OK

AT+CPBS="FD"
 +CME ERROR: SIM PIN2 required

AT+CPIN=PIN2 ← Enter PIN2
 OK

AT+CPBS="FD" ← Select "FD" phonebook storage
 OK



The following ones can substitute the previous two commands:

AT+CLCK="FD",1,PIN2
 OK.

AT+CPBS="MC" ← Select "MC" Phonebook Storage
 OK

AT+CPBS?
 +CPBS: "MC",0,20
 OK



After module power on and PIN authentication, the module reads the data records stored on the SIM. During this activity, the phonebook access is inhibited for a time interval depending on various factors. If Phonebook commands are entered during this interval, the module returns an error message. In this case, retry the operations later.

4.5.2.2. 3G Modules

Examples

AT+CPBS=? ← Read the supported range of Phonebook Storages
 +CPBS: ("SM","FD","LD","MC","RC","DC","ME","EN","ON")
 OK

AT+CPBS? ← Read the current phonebook storage
 +CPBS: "SM",19,250
 OK

4.5.3. Search Phonebook Entries

Use the following AT command to search a Phonebook entry.

AT+CPBF=<findtext>

Examples

Read the current Phonebook storage and select "SM" storage:

AT+CPBS?
 +CPBS: "MC",0,20
 OK

AT+CPBS="SM"
 OK

AT+CPBS?
 +CPBS: "SM",10,250
 OK

Look for entries having name starting with "FA" on the selected storage:

AT+CPBF="FA"
 +CPBF: 7,"+39404192XYZ",145,"Fabio"
 +CPBF: 9,"0404X92XYX",129,"Fabrizio"
 OK

Look for an entry not present on the selected storage. Before doing that verify if the Extended Error result code is enabled.

AT+CMEE?
 +CMEE: 2
 OK

AT+CPBF="FAUSTO"
 +CME ERROR: not found



The search for <name> string is not case sensitive and the string may or may not be included in double brackets.

4.5.4. Read Phonebook Entries

Use the following AT command to read a Phonebook entry:

AT+CPBR=<index1>[,<index2>]

Select "SM" storage:

AT+CPBS="SM"

OK

Look for the entry at the position index = 7:

AT+CPBR=7

+CPBR: 7,"+39404192XYZ",145,"Fabio"

OK

Look for the entries from position 7 up to position 9:

AT+CPBR=7,9

+CPBR: 7,"+39404192XYZ",145,"Fabio"

+CPBR: 9,"0404X92XYX",129,"Fabrizio"

OK

The position 8 is empty.

4.5.5. Write Phonebook Entry

Use the following AT command to write a Phonebook entry:

AT+CPBW=[<index>][,<number>[,<type>[,<text>]]]

Examples

Select the "SM" phonebook:

AT+CPBS="SM"

OK

Write a new record on the first free position of the selected "SM" phonebook:

AT+CPBW=,"0404192XYY",129,"NewRecord"

OK

Check where the new record has been written:

AT+CPBF="NEW"

+CPBF: 8,"0404192XYY",129,"NewRecord"

OK

4.5.6. Delete Phonebook Entry

Use the following AT command with only <index> parameter to delete a Phonebook entry:

AT+CPBW=<index>

Examples

Select the "SM" phonebook:

AT+CPBS="SM"
OK

Delete record 7 on the "SM" phonebook:

AT+CPBW= 7
OK

Try to delete a non-existent record on the "SM" phonebook, just to see the format response:

AT+CPBF=99999999999
+CME ERROR: not found



The delete command overwrites the <index> record number with an empty record.

4.5.7. Dial Phonebook Entry

To dial a phone number stored in the Phonebook, the user must get the desired phone number index position using the +CPBF command. Once the <index> number is known, the user can establish the call.

ATD><n>[:]

Wait for command response in accordance with the call type entered.

Examples

Establish a Voice call, on HS audio path, to "Fabio" whose number is stored on the SIM Phonebook:

Select the "SM" as active storage.

AT+CPBS="SM"
OK

Find the index number where "Fabio" is recorded.

AT+CPBF="Fabio"
+CPBF: 7,"+390404X9YYYY",145,"Fabio"
OK

Set up Voice Call.

AT+FCLASS=8
OK

Use software way to select HS audio path.

AT#CAP=2
OK

Set the volume.

AT+CLVL=8
OK

Check the mute setting.

AT+CMUT?
+CMUT: 0

Establish the voice call using the index.

ATD>7
OK

4.6. GSM Power Saving Modes

The Telit Modules provide a function that reduces the power consumption during the period when they are in IDLE state (waiting for a call), allowing a longer activity with a given battery capacity. The power saving function can be configured in several modes in accordance with the user needs.

In accordance with the response of the **AT+CFUN=?** Command, you can know the Power Saving Modes supported by the version of your Telit Module, refer to the table below:

Modules	Software Versions	AT+CFUN=?
2G	10.01.xxx, 13.00.xxx, 16.01.xxx	+CFUN: (0,1,2,4,5,7,9,10,11),(0, 1) OK
3G	12.00.xxx	+CFUN: (0,1,4,5,7,9),(0, 1) OK

Tab. 4: CFUN Modes & Software Versions

Use the following AT command to set the power saving mode:

AT+CFUN=[<fun>[,<rst>]]

Check the current mode:

AT+CFUN?

+CFUN: 1 ← module with full functionality and power saving disabled (factory setting)

OK

4.6.1. Some clarifications

1. When the module is powered ON the power saving function is disabled (CFUN=1, factory setting) to guarantee the radio functionality and data exchange between the module and the user device. Therefore, the needed CFUN mode command should be entered after every power ON.
2. The radio power ON/OFF activities require a delay between consecutive activation of the following CFUN commands:
 - CFUN=1 → CFUN=4 or CFUN=1 ← CFUN=4
 - CFUN=1 → CFUN=10 or CFUN=1 ← CFUN=10
 - CFUN=1 → CFUN=11 or CFUN=1 ← CFUN=11

It is suggested to use a delay of 10 sec.

3. If the entered CFUN command does not turn off the radio functionality, the power saving function does not affect the network activity of the module. During the power saving mode the module remains registered on the network and reachable for incoming calls, SMS, etc. If an

incoming call arrives during the power saving, the module will wake up and proceed normally to manage the call.

4. Assume that the module is in power saving mode. The paging time range is $0.5 \div 2.1$ sec, it depends upon DRX time set by the network; when the module wakes up from the power saving mode, it takes a maximum of 150 ms before checking the DTR line coming from the DTE. If a command is received during the power saving, the module needs at least $0.5 \div 2.1$ sec +150 msec to be ready. Hence, use a delay of at least 2250 msec between the port opening (DTR=ON) and command sending.
5. The CFUN mode can be saved into the selected profile only if the AT+CFUN command is entered into the module through the AT0 parser (Instance #1, refer to documents [10], [22]).

4.6.2. CFUN=0 and 3G Modules

For HE910 series the behavior of the CFUN=0 is conditioned by the setting of the AT#ENS command, refer to § 3.10.8.3, and 3.10.8.4.

- AT#ENS=0 ← CFUN=0 has the standard functionality
- AT#ENS=1 ← CFUN=0 has the same functionality of CFUN=4

4.6.3. CFUNs and the Main Serial Port

This chapter describes the relation between the CFUN modes and the control lines (RTS, CTS refer to § 3.1) of the Main Serial Port (hereafter called AT interface). The § 4.6.4 describes the wake up events (for example, unsolicited result code) that force the module to exit from the power saving mode temporarily or permanently.

CFUN=2, CFUN=4

These CFUN modes do not interact with the control serial lines of the AT interface.

Type in CFUN=2, the module disables Tx.

Type in CFUN=4, the module performs network deregistration, and SIM deactivation.

CFUN=0, CFUN=9

Here is the starting control lines configuration, the AT interface is working.

<DSR=ON>, RI=OFF, DCD=OFF, <CTS=ON>, RTS=ON (or OFF), DTR=ON

Type in CFUN=0 or CFUN=9. The module enters the NON-CYCLIC SLEEP mode, and the AT interface is no longer accessible. Here is the new control lines configuration. <DSR=OFF>, RI=OFF, DCD=OFF, <CTS=OFF>, RTS=ON (or OFF), DTR=ON.

Power saving mode is identified by <DSR=OFF>, <CTS=OFF>. Do not send further characters, they remain in the input buffer and may delay the output of an unsolicited result code.

- The RTS line toggling forces the module to exit power saving and enter CFUN=1 mode. The AT interface is again accessible.

The power saving mode (0 or 9) does not affect the radio activities of the module. It remains registered on the network and reachable for incoming calls or SMS. If a call comes during the power saving mode, the module will wake up, enters CFUN=1 mode, and proceeds normally with the unsolicited incoming call code.

CFUN=7

Here is the starting control lines configuration, the AT interface is working.

<DSR=ON>, RI=OFF, DCD=OFF, <CTS=ON>, RTS=ON (or OFF), DTR=ON

Type in CFUN=7, the module enters the CYCLIC SLEEP mode. It sets periodically the CTS control line to ON to enable the AT interface for a short time. The period, between two consecutive CTS OFF→ON transitions, extends from some sec to some tens of sec, its variability depends on the internal timing of the module. If characters are recognized on the AT interface, the module stays active for about 2 sec after the last character has been sent or received, see

Fig. 4.

- The module exits CYCLIC SLEEP mode only if AT+CFUN=1 is entered.

The power saving mode 7 does not affect radio activities of the module. It remains registered on the network and reachable for incoming calls or SMS. If call incomes during the power saving mode, the module will wake up, proceed normally with the unsolicited incoming call code, and after that enters again CFUN=7 mode.

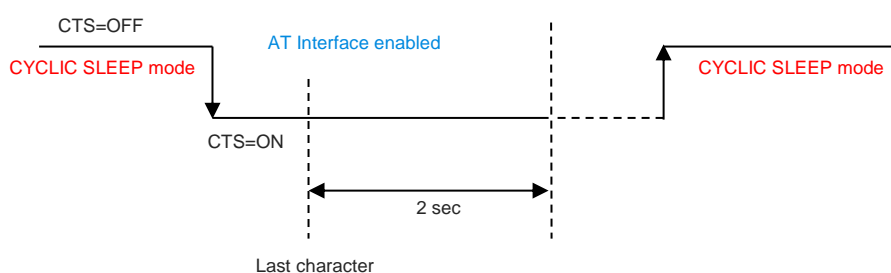

Fig. 4: CFUN=7, Cyclic Sleep

CFUN=5

Here is the starting control lines configuration, the AT interface is working.

<DSR=ON>, RI=OFF, DCD=OFF, <CTS=ON>, RTS=ON (or OFF), DTR=ON

Type in CFUN=5. The module has full functionality, and the power saving mode is enabled.

To force the module in power saving mode the DTE must set DTR control line to OFF.

Here is the new control lines configuration.

<DSR=OFF>, RI=OFF, DCD=OFF, <CTS=OFF>, RTS=ON (or OFF), DTR=OFF

- The AT interface is no longer accessible. Power saving mode is identified by <DSR=OFF>, <CTS=OFF>.
- The module is in power saving mode. The DTE must set the DTR control line to ON, and wait that the module sets the CTS/DSR control lines to ON, before sending any AT command. Now, the AT interface is accessible, but the module is still in CFUN=5 mode. Enter CFUN=1 to exit CFUN=5 mode.
- The module will go back in the power saving mode when the DTE sets DTR line to OFF.

The power saving mode 5 does not affect the radio functionalities of the module. It remains registered on the network and reachable for incoming calls or SMS. If call incomes during the power saving mode, the module will wake up, proceed normally with the unsolicited incoming call code, and after that enters again CFUN=5 mode, it is a CYCLIC SLEEP mode.

CFUN=10

Here is the starting control lines configuration, the AT interface is working.

<DSR=ON>, RI=OFF, DCD=OFF, <CTS=ON>, RTS=ON (or OFF), DTR=ON

Enter CFUN=10. The module is detached from the network (TX and RX are disabled), the SIM is deactivated, and the power saving mode is enabled.

- To force the module in power saving mode the DTE must set DTR control line to OFF. Here is the new control lines configuration.
- <DSR=OFF>, RI=OFF, DCD=OFF, <CTS=OFF>, RTS=ON (or OFF), DTR=OFF
- The AT interface is no longer accessible. Power saving mode is identified by <DSR=OFF>, <CTS=OFF>.
- The module is in power saving mode. The DTE must set the DTR control line to ON, and wait that the module sets the CTS/DSR control lines to ON, before sending any AT command. Now, the AT interface is accessible, but the module is still in CFUN=10 mode. Enter CFUN=1 to exit CFUN=10 mode.
- The module will go back in the power saving mode when the DTE sets DTR line to OFF.

CFUN=11

Here is the starting control lines configuration, the AT interface is working.

<DSR=ON>, RI=OFF, DCD=OFF, <CTS=ON>, RTS=ON (or OFF), DTR=ON

Enter CFUN=11. The module is detached from the network (TX and RX are disabled), the SIM is deactivated, and the power saving mode is automatically entered. Here is the new control lines configuration.

<DSR=OFF>, RI=OFF, DCD=OFF, <CTS=OFF>, RTS=ON (or OFF), DTR=ON

The AT interface is no longer accessible. Power saving mode is identified by <DSR=OFF>, <CTS=OFF>

- The module is in power saving. It monitors the RTS toggling every N seconds to change the current AT interface state (accessible/not accessible). The range of N extends from some sec to some tens of sec, its variability depends on the internal timing of the module. In any case, the CFUN=11 mode is still active.
- When the AT interface is accessible, enter CFUN=1 to exit CFUN=11mode.

4.6.4. CFUNs and Wake up Events



It is suggested to read § 4.6.3 before reading the Tab. 5. See CFUN examples in § 4.6.5.

The Tab. 5 shown in the next page summarizes the behavior of the CFUN modes in relation with specific wake up event. The shaded row lists the available CFUN modes; the shaded Wake up Events column lists the possible events. Therefore, the cell on the crossing between the selected CFUN mode column and the row of the selected wake up event shows the new CFUN mode entered by the module after the occurrence of the wake up event. It is assumed that the wake up events occur when the module is in power saving mode.

The "N/A" abbreviation indicates that the specific wake up event shown in the table is not applicable to the selected CFUN. For example, incoming voice call is not applicable when the module is in CFUN=4 mode because the radio is turned off.

"The new mode depends on URC" means that the final CFUN mode of the module depends on the type of the URC. For example, if the wake up event is the extraction of the SIM, #QSS URC is not generated if the module is in CFUN=4 mode because the SIM is deactivated, see § 4.6.5.1.

	CFUN=0	CFUN=2	CFUN=4	CFUN=5	CFUN=7	CFUN=9	CFUN=10	CFUN=11
Wake up Events	Module enters NON-CYCLIC SLEEP mode. Refer § 4.6.3	Disable TX.	The module performs network deregistration and SIM deactivation. TX and RX are disabled.	The power saving is enabled Refer § 4.6.3	Module enters CYCLIC SLEEP mode. Refer § 4.6.3	Module enters NON-CYCLIC SLEEP mode. Refer § 4.6.3	The module performs network deregistration and SIM deactivation. TX and RX are disabled. The power saving is enabled. Refer § 4.6.3	The module performs network deregistration and SIM deactivation. TX and RX are disabled. The module enters automatically in power saving mode. Refer § 4.6.3
Unsolicited Result Code	The new mode depends on URC.	The new mode depends on URC.	The new mode depends on URC.	The new mode depends on URC.	The new mode depends on URC.	The new mode depends on URC.	The new mode depends on URC.	The new mode depends on URC.
Incoming voice/data call	Incoming call is managed, RING is displayed. The module exits power saving state and enters CFUN=1 mode.	N/A	N/A	Incoming call is managed, RING is displayed. DTR is used to exit/ enter power saving state in CFUN=5 mode.	Incoming call is managed. RING is displayed, power saving state is exited. ATH command is used to enter again power saving state in CFUN=7 mode.	Incoming call is managed, RING is displayed. The module exits power saving state and enters CFUN=1 mode.	N/A	N/A
Incoming SMS AT+CNMI=0,0, ...	Incoming SMS is managed, URC is not displayed. The module stays in power saving state in CFUN=0 mode	N/A	N/A	Incoming SMS is managed, URC is not displayed. DTR is used to exit/ enter power saving state in CFUN=5 mode.	Incoming SMS is managed, URC is not displayed. CTS is toggling, module is in power saving state in CFUN=7 mode.	Incoming SMS is managed, URC is not displayed. The module stays in power saving state in CFUN=9 mode.	N/A	N/A
Incoming SMS AT+CNMI=1,1, ...	Incoming SMS is managed, URC is displayed. The module exits power saving state and enters CFUN=1 mode	N/A	N/A	Incoming SMS is managed, URC is displayed. DTR is used to exit/ enter power saving state in CFUN=5 mode.	Incoming SMS is managed, URC is displayed. CTS is toggling, module is in power saving state in CFUN=7 mode.	Incoming SMS is managed, URC is displayed. The module exits power saving state and enters CFUN=1 mode.	N/A	N/A

Tab. 5: CFUN Modes & Wake up Events (con't)

	CFUN=0	CFUN=2	CFUN=4	CFUN=5	CFUN=7	CFUN=9	CFUN=10	CFUN=11
Wake up Events	Module enters NON-CYCLIC SLEEP mode. Refer § 4.6.3	Disable TX.	The module performs network deregistration and SIM deactivation. TX and RX are disabled.	The power saving is enabled Refer § 4.6.3	Module enters CYCLIC SLEEP mode. Refer § 4.6.3	Module enters NON-CYCLIC SLEEP mode. Refer § 4.6.3	The module performs network deregistration and SIM deactivation. TX and RX are disabled. The power saving is enabled. Refer § 4.6.3	The module performs network deregistration and SIM deactivation. TX and RX are disabled. The module enters automatically in power saving mode. Refer § 4.6.3
Incoming GPRS packet	a)	N/A	N/A	CFUN=5	CFUN=7	CFUN=1	N/A	N/A
RTC alarm	CFUN=1	CFUN=2	CFUN=4	CFUN=5	CFUN=7	CFUN=1	CFUN=10	CFUN=11
AT+CFUN=1	/	CFUN=1	CFUN=1	/	/	/	/	/
RTS toggling	CFUN=1	/	/	/	/	CFUN=1	/	/
RTS toggling + AT+CFUN=1	/	/	/	/	/	/	/	CFUN=1
DTR=ON + AT+CFUN=1	/	/	/	CFUN=1	/	/	CFUN=1	/
CTS=ON + AT+CFUN=1	/	/	/	/	CFUN=1	/	/	/

a) For modules having: 12.00.006 sw: CFUN=0 → CFUN=1;
13.00.xxx sw: CFUN=0 → CFUN=0.

4.6.5. CFUN Examples

4.6.5.1. CFUN=0: Call, SMS, #QSS, +CALA

Example 1

The wake up event is an incoming call.

Starting control line configuration, AT interface is enabled.

```
<DSR=ON>, RI=OFF, DCD=OFF, <CTS=ON>, RTS=ON, DTR=ON
```

Type in CFUN=0, the module enters NON-CYCLIC SLEEP mode.

```
AT+CFUN=0  
OK
```

Here is the new control line configuration. The module is in power saving.

```
<DSR=OFF>, RI=OFF, DCD=OFF, <CTS=OFF>, RTS=ON, DTR=ON
```

An incoming call is arrived.

```
RING  
RING
```

Here is the new control line configuration. The module is no longer in power saving.

```
<DSR=ON>, RI=ON, DCD=OFF, <CTS=OFF>, RTS=ON, DTR=ON
```

```
RING  
RING
```

Check the current CFUN.

```
AT+CFUN?  
+CFUN: 1 ← the module is in full functionality mode  
OK
```

```
RING  
RING
```

Hang up the call.

```
ATH  
OK
```

Here is the new control line configuration.

```
<DSR=ON>, RI=OFF, DCD=OFF, <CTS=ON>, RTS=ON, DTR=ON
```

Example 2

The wake up event is a SMS receiving.

Enable URC created by the SMS receiving.

```
AT+CNMI=1,1,0,0,0  
OK
```

Starting control line configuration, AT interface is enabled.

<DSR=ON>, RI=OFF, DCD=OFF, <CTS=ON>, RTS=ON, DTR=ON

Type in CFUN=0, the module enters NON-CYCLIC SLEEP mode.

AT+CFUN=0
OK

Here is the new control line configuration. The module is in power saving.

<DSR=OFF>, RI=OFF, DCD=OFF, <CTS=OFF>, RTS=ON, DTR=ON

A SMS is arrived.

+CMTI: "SM",17

Here is the new control line configuration. The module is no longer in power saving.

<DSR=ON>, RI=OFF, DCD=OFF, <CTS=ON>, RTS=ON, DTR=ON

Check the current CFUN.

AT+CFUN?
+CFUN: 1 ← the module is in full functionality mode
OK

Example 3

The wake up event is a SMS receiving.

Disable URC created by the SMS receiving.

AT+CNMI=0,0,0,0,0
OK

Starting control line configuration, AT interface is enabled.

<DSR=ON>, RI=OFF, DCD=OFF, <CTS=ON>, RTS=ON, DTR=ON

Type in CFUN=0, the module enters NON-CYCLIC SLEEP mode.

AT+CFUN=0
OK

Here is the new control line configuration. The module is in power saving.

<DSR=OFF>, RI=OFF, DCD=OFF, <CTS=OFF>, RTS=ON, DTR=ON

A SMS is sent and received. The DTE does not displays the URC +CMTI.

Control line configuration does not change. The module is still in power saving, in CFUN=0 mode.

<DSR=OFF>, RI=OFF, DCD=OFF, <CTS=OFF>, RTS=ON, DTR=ON

Toggle RTC control line to exit power saving in CFUN=0 mode, and enter CFUN=1 mode. Here is the new control line configuration.

<DSR=ON>, RI=OFF, DCD=OFF, <CTS=ON>, RTS=OFF, DTR=ON

Example 4

The wake up event is the #QSS URC.

Starting control line configuration, AT interface is enabled.

<DSR=ON>, RI=OFF, DCD=OFF, <CTS=ON>, RTS=ON, DTR=ON

Enable Query SIM Status URC.

AT#QSS=1

OK

Type in CFUN=0, the module enters NON-CYCLIC SLEEP mode.

AT+CFUN=0

OK

Here is the new control line configuration. The module is in power saving.

<**DSR=OFF**>, RI=OFF, DCD=OFF, <**CTS=OFF**>, RTS=ON, DTR=ON

Extract the SIM. After a while, the DTE displays the following URC:

#QSS:0

Here is the new control line configuration. The module is no longer in power saving.

<**DSR=ON**>, RI=OFF, DCD=OFF, <**CTS=ON**>, RTS=ON, DTR=ON

Check the current CFUN mode.

AT+CFUN?

+CFUN: 1 ← the module is in full functionality mode

OK

Example 5

+CALA URC event forces the module in CFUN=1 mode.

Starting control line configuration, AT interface is enabled.

<DSR=ON>, RI=OFF, DCD=OFF, <CTS=ON>, RTS=ON, DTR=ON

Set the clock

AT+CCLK="08/05/16,09:20:30+00"

OK

Set when the alarm wakes up: in two minutes (it is just an example).

AT+CALA="08/05/16,09:22:30+00",0,2,"ALARM, ALARM, ALARM"

OK

Type in CFUN=0, the module enters NON-CYCLIC SLEEP mode.

AT+CFUN=0

OK

Here is the new control line configuration. The module is in power saving.

<**DSR=OFF**>, RI=OFF, DCD=OFF, <**CTS=OFF**>, RTS=ON, DTR=ON

During the ALARM waiting, the module is in power saving and the AT interface is disabled.

When the alarm wakes up, the DTE displays the URCs. The module exits power saving in CFUN=0 mode, and enters CFUN=1 mode.

+CALA: ALARM, ALARM, ALARM

Here is the new control line configuration.

<DSR=ON>, RI=OFF, DCD=OFF, <CTS=ON>, RTS=ON, DTR=ON

+CALA: ALARM, ALARM, ALARM

Check the alarm mode

AT#WAKE?

#WAKE: 1 ← the module is in alarm mode

OK

+CALA: ALARM, ALARM, ALARM

Check the current CFUN.

AT+CFUN?

+CFUN: 1 ← the module is in full functionality mode

OK

+CALA: ALARM, ALARM, ALARM

+CALA: ALARM, ALARM, ALARM

After 90 sec, the module exits alarm mode.

Check the alarm mode.

AT#WAKE?

#WAKE: 0 ← the module exited alarm mode

OK

4.6.5.2. CFUN=2: #QSS, +CALA

Example 1

#QSS URC event leaves the module in CFUN=2 mode.

Starting control line configuration, AT interface is enabled.

<DSR=ON>, RI=OFF, DCD=OFF, <CTS=ON>, RTS=ON, DTR=ON

Type in CFUN=2, the module disable Tx.

AT+CFUN=2

OK

Control line configuration is not changed.

<DSR=ON>, RI=OFF, DCD=OFF, <CTS=ON>, RTS=ON, DTR=ON

Enable Query SIM Status URC.

AT#QSS=1

OK

Extract the SIM. After a while, the DTE displays the following URC:

#QSS:0

Control line configuration is not changed.

<DSR=ON>, RI=OFF, DCD=OFF, <CTS=ON>, RTS=ON, DTR=ON

Check the current CFUN mode.

AT+CFUN?

+CFUN: 2 ← the CFUN mode is not changed.

OK

Example 2

+CALA URC event leaves the module in CFUN=2 mode.

Starting control line configuration, AT interface is enabled.

<DSR=ON>, RI=OFF, DCD=OFF, <CTS=ON>, RTS=ON, DTR=ON

Set the clock

AT+CCLK="08/05/16,09:20:30+00"

OK

Set when the alarm wakes up: in two minutes (it is just an example).

AT+CALA="08/05/16,09:22:30+00",0,2,"ALARM, ALARM, ALARM"

OK

Type in CFUN=2, the module disable Tx.

AT+CFUN=2

OK

Control line configuration is not changed

<DSR=ON>, RI=OFF, DCD=OFF, <CTS=ON>, RTS=ON, DTR=ON

When the alarm wakes up, the DTE displays the URCs.

+CALA: ALARM, ALARM, ALARM

Control line configuration is not changed.

<DSR=ON>, RI=OFF, DCD=OFF, <CTS=ON>, RTS=ON, DTR=ON

+CALA: ALARM, ALARM, ALARM

Check the alarm mode

AT#WAKE?

#WAKE: 1 ← the module is in alarm mode

OK

+CALA: ALARM, ALARM, ALARM

The module does not change CFUN mode.

AT+CFUN?

+CFUN: 2
OK

+CALA: ALARM, ALARM, ALARM

After 90 sec, the module exits alarm mode.

Check the alarm mode.

AT#WAKE?

#WAKE: 0 ← the module exited alarm mode
OK

The module does not change CFUN mode.

AT+CFUN?

+CFUN: 2
OK

4.6.5.3. CFUN=4: #QSS, +CALA

Example 1

#QSS URC event leaves the module in CFUN=4 mode.

Starting control line configuration, AT interface is enabled.

<DSR=ON>, RI=OFF, DCD=OFF, <CTS=ON>, RTS=ON, DTR=ON

Type in CFUN=4, the module performs network deregistration, and SIM deactivation.

AT+CFUN=4

OK

Control line configuration is not changed.

<DSR=ON>, RI=OFF, DCD=OFF, <CTS=ON>, RTS=ON, DTR=ON

Enable Query SIM Status URC.

AT#QSS=1

OK

Extract the SIM. The URC does not arrive because CFUN=4 mode deactivates the SIM.

The module stays in CFUN=4 mode.

AT+CFUN?

+CFUN: 4
OK

Example 2

+CALA URC event leaves the module in CFUN=4 mode.

Starting control line configuration, AT interface is enabled.

<DSR=ON>, RI=OFF, DCD=OFF, <CTS=ON>, RTS=ON, DTR=ON

Set the clock

```
AT+CCLK="08/05/16,09:20:30+00"  
OK
```

Set when the alarm wakes up: in two minutes (it is just an example).

```
AT+CALA="08/05/16,09:22:30+00",0,2,"ALARM, ALARM, ALARM"  
OK
```

Type in CFUN=4, the module performs network deregistration, and SIM deactivation.

```
AT+CFUN=4  
OK
```

Control line configuration is not changed

<DSR=ON>, RI=OFF, DCD=OFF, <CTS=ON>, RTS=ON, DTR=ON

When the alarm wakes up, the DTE displays the URCs.

```
+CALA: ALARM, ALARM, ALARM
```

Control line configuration is not changed.

<DSR=ON>, RI=OFF, DCD=OFF, <CTS=ON>, RTS=ON, DTR=ON

```
+CALA: ALARM, ALARM, ALARM
```

Check the alarm mode

```
AT#WAKE?  
#WAKE: 1 ← the module is in alarm mode  
OK
```

```
+CALA: ALARM, ALARM, ALARM
```

The module does not change CFUN mode.

```
AT+CFUN?  
+CFUN: 4  
OK
```

```
+CALA: ALARM, ALARM, ALARM
```

After 90 sec, the module exits alarm mode.

Check the alarm mode.

```
AT#WAKE?  
#WAKE: 0 ← the module exited alarm mode  
OK
```

The module does not change CFUN mode.

```
AT+CFUN?  
+CFUN: 4  
OK
```

4.6.5.4. CFUN=5: Call, SMS, +CALA

Example 1

The wake up event is an incoming call.

Starting control line configuration, AT interface is enabled.

```
<DSR=ON>, RI=OFF, DCD=OFF, <CTS=ON>, RTS=ON, DTR=ON
```

Force the module in CFUN=5 mode, the power saving is enabled.

```
AT+CFUN=5  
OK
```

Control line configuration does not change, AT interface is still enabled.

```
<DSR=ON>, RI=OFF, DCD=OFF, <CTS=ON>, RTS=ON, DTR=ON
```

Force the module in power saving.

```
DTR → OFF
```

The module is in power saving, and the AT interface is disabled.

```
<DSR=OFF>, RI=OFF, DCD=OFF, <CTS=OFF>, RTS=ON, DTR=OFF
```

An incoming call is arrived

```
RING  
RING
```

Here is the new control line configuration: RING=ON

```
<DSR=OFF>, RI=ON, DCD=OFF, <CTS=OFF>, RTS=ON, DTR=OFF
```

```
RING  
RING
```

Exit power saving, and enable again the hardware flow control of the serial port.

```
DTR→ON
```

```
<DSR=ON>, RI=ON, DCD=OFF, <CTS=ON>, RTS=ON, DTR=ON
```

The module exits power saving, but stays in CFUN=5 mode.

```
AT+CFUN?  
+CFUN:5  
OK
```

```
RING  
RING
```

Hang up the call.

```
ATH  
OK
```

Enter power saving.

DTR → OFF

The module enters again the power saving mode, and the AT interface is disabled.

<DSR=OFF>, RI=OFF, DCD=OFF, <CTS=OFF>, RTS=ON, DTR=OFF

Example 2

The wake up event is a SMS receiving.

Enable URC created by the SMS receiving.

AT+CNMI=1,1,0,0,0

OK

Starting control line configuration, AT interface is enabled.

<DSR=ON>, RI=OFF, DCD=OFF, <CTS=ON>, RTS=ON, DTR=ON

Force the module in CFUN=5 mode, the power saving is enabled.

AT+CFUN=5

OK

Control line configuration does not change, AT interface is still enabled.

<DSR=ON>, RI=OFF, DCD=OFF, <CTS=ON>, RTS=ON, DTR=ON

Force the module in power saving.

DTR → OFF

The module is in power saving and the AT interface is disabled.

<DSR=OFF>, RI=OFF, DCD=OFF, <CTS=OFF>, RTS=ON, DTR=OFF

A SMS is arrived.

+CMTI: "SM",17

The module is still in power saving and the AT interface is disabled.

<DSR=OFF>, RI=OFF, DCD=OFF, <CTS=OFF>, RTS=ON, DTR=OFF

Exit power saving, and enable again the hardware flow control of the serial line.

DTR → ON

<DSR=ON>, RI=OFF, DCD=OFF, <CTS=ON>, RTS=ON, DTR=ON

The module exits power saving, but stays in CFUN=5 mode.

AT+CFUN?

+CFUN:5

OK

Enter power saving.

DTR → OFF

The module enters again the power saving mode, and the AT interface is disabled.

<**DSR=OFF**>, RI=OFF, DCD=OFF, <**CTS=OFF**>, RTS=ON, DTR=OFF

Example 3

The wake up event is a SMS receiving

Check the number of SMS already arrived.

AT+CPMS?

+CPMS: "SM",18,30,"SM",18,30,"SM",18,30 ← Yes, a new SMS is arrived.

OK

Disable URC created by the SMS receiving.

AT+CNMI=0,0,0,0,0

OK

Starting control line configuration, AT interface is enabled.

<**DSR=ON**>, RI=OFF, DCD=OFF, <**CTS=ON**>, RTS=ON, DTR=ON

Force the module in CFUN=5 mode, the power saving is enabled.

AT+CFUN=5

OK

Control line configuration does not change, AT interface is still enabled.

<**DSR=ON**>, RI=OFF, DCD=OFF, <**CTS=ON**>, RTS=ON, DTR=ON

Force the module in power saving.

DTR → OFF

The module is in power saving and the AT interface is disabled.

<**DSR=OFF**>, RI=OFF, DCD=OFF, <**CTS=OFF**>, RTS=ON, DTR=OFF

A SMS is sent and arrived. The DTE does not displays the URC +CMTI.

The module is still in power saving and the AT interface is disabled.

<**DSR=OFF**>, RI=OFF, DCD=OFF, <**CTS=OFF**>, RTS=ON, DTR=OFF

Exit power saving, and enable again the hardware flow control of the serial line.

DTR → ON

<**DSR=ON**>, RI=OFF, DCD=OFF, <**CTS=ON**>, RTS=ON, DTR=ON

The module exits power saving, but stays in CFUN=5 mode.

AT+CFUN?

+CFUN:5

OK

Check if a new SMS is arrived.

AT+CPMS?

+CPMS: "SM",19,30,"SM",19,30,"SM",19,30 ← Yes, a new SMS is arrived.

OK

Enter power saving.

DTR→OFF

The module enters again the power saving mode, and the AT interface is disabled.

<**DSR=OFF**>, RI=OFF, DCD=OFF, <**CTS=OFF**>, RTS=ON, DTR=OFF

Example 4

+CALA URC event leaves the module in CFUN=5 mode.

Starting control line configuration, AT interface is enabled.

<**DSR=ON**>, RI=OFF, DCD=OFF, <**CTS=ON**>, RTS=ON, DTR=ON

Force the module in CFUN=5 mode, the power saving is enabled.

AT+CFUN=5

OK

Control line configuration does not change, AT interface is still enabled.

<**DSR=ON**>, RI=OFF, DCD=OFF, <**CTS=ON**>, RTS=ON, DTR=ON

Set the clock

AT+CCLK="08/05/16,09:20:30+00"

OK

Set when the alarm wakes up: in two minutes (it is just an example).

AT+CALA="08/05/16,09:21:30+00",0,2,"ALARM, ALARM, ALARM"

OK

Force the module in power saving.

DTR → OFF

During the ALARM waiting, the module is in power saving, and the AT interface is disabled.

<**DSR=OFF**>, RI=OFF, DCD=OFF, <**CTS=OFF**>, RTS=ON, DTR=OFF

When the alarm time is expired, DTE displays the URCs.

+CALA: ALARM, ALARM, ALARM

The AT interface is disabled.

Now, enable AT interface. The module exits power saving, but stays in CFUN=5 mode.

DTR → ON

<**DSR=ON**>, RI=OFF, DCD=OFF, <**CTS=ON**>, RTS=ON, DTR=ON

+CALA: ALARM, ALARM, ALARM

+CALA: ALARM, ALARM, ALARM

Check if the module is in alarm mode.

AT#WAKE?

#WAKE: 1
OK

+CALA: ALARM, ALARM, ALARM

Check the current CFUN.

AT+CFUN?

+CFUN: 5
OK

+CALA: ALARM, ALARM, ALARM

After 90 sec the module exits alarm mode.

AT#WAKE?

#WAKE: 0
OK

Check the current CFUN.

AT+CFUN?

+CFUN: 5
OK

Force the module in power saving.

DTR → OFF

The module is in power saving in CFUN=5 mode, and the AT interface is disabled.

<DSR=OFF>, RI=OFF, DCD=OFF, <CTS=OFF>, RTS=ON, DTR=OFF

4.6.5.5. CFUN=7: Call, SMS, +CALA

Example 1

The wake up event is an incoming call.

Starting control line configuration, AT interface is enabled.

<DSR=ON>, RI=OFF, DCD=OFF, <CTS=ON>, RTS=ON, DTR=ON

Force the module in CFUN=7 mode, the module toggles CTS control line.

AT+CFUN=7

OK

CTS is toggling.

<DSR=ON>, RI=OFF, DCD=OFF, <CTS=ON/OFF>, RTS=ON, DTR=ON

An incoming call is arrived

RING
RING

CTS is no longer toggling, RI=ON. The AT interface is permanently enabled, CTS=ON.

<DSR=ON>, RI=ON, DCD=OFF, <CTS=ON>, RTS=ON, DTR=ON

RING
RING

The module exits power saving, but stays in CFUN=7 mode.

AT+CFUN?
+CFUN:7
OK

RING
RING

Hang up the call.

ATH
OK

CTS is toggling, the module enters again the power saving mode.

<DSR=ON>, RI=OFF, DCD=OFF, <CTS=ON/OFF>, RTS=ON, DTR=ON

Example 2

The wake up event is a SMS receiving

Enable URC created by the SMS receiving.

AT+CNMI=1,1,0,0,0
OK

Starting control line configuration, AT interface is enabled.

<DSR=ON>, RI=OFF, DCD=OFF, <CTS=ON>, RTS=ON, DTR=ON

Force the module in CFUN=7 mode, the module toggles CTS control line.

AT+CFUN=7
OK

CTS is toggling.

<DSR=ON>, RI=OFF, DCD=OFF, <CTS=ON/OFF>, RTS=ON, DTR=ON

A SMS is arrived

+CMTI: "SM",17

CTS is still toggling. The module stays in CFUN=7 mode.

<DSR=ON>, RI=OFF, DCD=OFF, <CTS=ON/OFF>, RTS=ON, DTR=ON

Example 3

The wake up event is a SMS receiving

Disable URC created by the SMS receiving.

AT+CNMI=0,0,0,0,0

OK

Starting control line configuration, AT interface is enabled.

<DSR=ON>, RI=OFF, DCD=OFF, <CTS=ON>, RTS=ON, DTR=ON

Force the module in CFUN=7 mode, the module toggles CTS control line.

AT+CFUN=7

OK

CTS is toggling.

<DSR=ON>, RI=OFF, DCD=OFF, <CTS=ON/OFF>, RTS=ON, DTR=ON

A SMS is sent and received. The DTE does not displays the URC +CMTI.

CTS is still toggling. The module stays in CFUN=7 mode.

<DSR=ON>, RI=OFF, DCD=OFF, <CTS=ON/OFF>, RTS=ON, DTR=ON

Example 4

+CALA URC event leaves the module in CFUN=7 mode.

Starting control line configuration, AT interface is enabled.

<DSR=ON>, RI=OFF, DCD=OFF, <CTS=ON>, RTS=ON, DTR=ON

Set the clock

AT+CCLK="08/05/16,09:20:30+00"

OK

Set when the alarm wakes up: in two minutes (it is just an example).

AT+CALA="08/05/16,09:22:30+00",0,2,"ALARM, ALARM, ALARM"

OK

Force the module in CFUN=7 mode, the module toggles CTS control line.

AT+CFUN=7

OK

CTS is toggling.

<DSR=ON>, RI=OFF, DCD=OFF, <CTS=ON/OFF>, RTS=ON, DTR=ON

When the alarm time is expired, DTE displays the URCs.

+CALA: ALARM, ALARM, ALARM

CTS is still toggling.

<DSR=ON>, RI=OFF, DCD=OFF, <CTS=ON/OFF>, RTS=ON, DTR=ON

+CALA: ALARM, ALARM, ALARM

Check the alarm mode

AT#WAKE?

#WAKE: 1 ← the module is in alarm mode
OK

+CALA: ALARM, ALARM, ALARM

+CALA: ALARM, ALARM, ALARM

The module does not change CFUN mode.

AT+CFUN?

+CFUN: 7

OK

+CALA: ALARM, ALARM, ALARM

After 90 sec, the module exits alarm mode.

Check the alarm mode.

AT#WAKE?

#WAKE: 0 ← the module is no longer in alarm mode

OK

The module does not change CFUN mode.

AT+CFUN?

+CFUN: 7

OK

4.6.5.6. CFUN=9: +CALA

+CALA URC event forces the module in CFUN=1 mode.

Starting control line configuration, AT interface is enabled.

<DSR=ON>, RI=OFF, DCD=OFF, <CTS=ON>, RTS=ON, DTR=ON

Set the clock

AT+CCLK="08/05/16,09:20:30+00"

OK

Set when the alarm wakes up: in two minutes (it is just an example).

AT+CALA="08/05/16,09:22:30+00",0,2,"ALARM, ALARM, ALARM"

OK

Type in CFUN=9, the module enters NON-CYCLIC SLEEP mode.

AT+CFUN=9

OK

Here is the new control line configuration. The module is in power saving.

<**DSR=OFF**>, RI=OFF, DCD=OFF, <**CTS=OFF**>, RTS=ON, DTR=ON

During the ALARM waiting, the module is in power saving and the AT interface is disabled.

When the alarm wakes up, the DTE displays the URCs. The module exits power saving in CFUN=9 mode, and enters CFUN=1 mode.

+CALA: ALARM, ALARM, ALARM

Here is the new control line configuration.

<DSR=ON>, RI=OFF, DCD=OFF, <CTS=ON>, RTS=ON, DTR=ON

+CALA: ALARM, ALARM, ALARM

Check the alarm mode

AT#WAKE?

#WAKE: 1 ← the module is in alarm mode

OK

+CALA: ALARM, ALARM, ALARM

Check the current CFUN.

AT+CFUN?

+CFUN: 1 ← the module is in full functionality mode

OK

+CALA: ALARM, ALARM, ALARM

+CALA: ALARM, ALARM, ALARM

After 90 sec, the module exits alarm mode.

Check the alarm mode.

AT#WAKE?

#WAKE: 0 ← the module exited from alarm mode

OK

4.6.5.7. CFUN=10: +CALA

+CALA URC event leaves the module in CFUN=10 mode.

Starting control line configuration, AT interface is enabled.

<DSR=ON>, RI=OFF, DCD=OFF, <CTS=ON>, RTS=ON, DTR=ON

Force the module in CFUN=10 mode, the module performs network deregistration, and SIM deactivation. The power saving is enabled.

AT+CFUN=10

OK

Control line configuration does not change, AT interface is still enabled.

<DSR=ON>, RI=OFF, DCD=OFF, <CTS=ON>, RTS=ON, DTR=ON

Set the clock

AT+CCLK="08/05/16,09:20:30+00"

OK

Set when the alarm wakes up: in two minutes (it is just an example).

```
AT+CALA="08/05/16,09:21:30+00",0,2,"ALARM, ALARM, ALARM"
OK
```

Force the module in power saving.

```
DTR → OFF
```

During the ALARM waiting, the module is in power saving and the AT interface is disabled.

```
<DSR=OFF>, RI=OFF, DCD=OFF, <CTS=OFF>, RTS=ON, DTR=OFF
```

The DTE displays the URCs only if the AT interface is enabled. Enable AT interface. The module exits power saving, but stays in CFUN=10 mode.

```
DTR → ON
```

```
<DSR=ON>, RI=OFF, DCD=OFF, <CTS=ON>, RTS=ON, DTR=ON
```

```
+CALA: ALARM, ALARM, ALARM
```

Check if the module is in alarm mode.

```
AT#WAKE?
```

```
#WAKE: 1
```

```
OK
```

```
+CALA: ALARM, ALARM, ALARM
```

Check the current CFUN.

```
AT+CFUN?
```

```
+CFUN: 10
```

```
OK
```

```
+CALA: ALARM, ALARM, ALARM
```

After 90 sec the module exits alarm mode.

```
AT#WAKE?
```

```
#WAKE: 0
```

```
OK
```

Check the current CFUN.

```
AT+CFUN?
```

```
+CFUN: 10
```

```
OK
```

Force the module in power saving.

```
DTR → OFF
```

The module is in power saving in CFUN=10 mode, and the AT interface is disabled.

```
<DSR=OFF>, RI=OFF, DCD=OFF, <CTS=OFF>, RTS=ON, DTR=OFF
```

4.6.5.8. CFUN=11: +CALA

+CALA URC event leaves the module in CFUN=11 mode.

Starting control line configuration, AT interface is enabled.

<DSR=ON>, RI=OFF, DCD=OFF, <CTS=ON>, RTS=ON, DTR=ON

Set the clock

```
AT+CCLK="08/05/16,09:20:30+00"
OK
```

Set when the alarm wakes up: in two minutes (it is just an example).

```
AT+CALA="08/05/16,09:22:30+00",0,2,"ALARM, ALARM, ALARM"
OK
```

Type in CFUN=11 mode. The module performs network deregistration, SIM deactivation. Tx and Rx are disabled, and power saving is automatically entered.

```
AT+CFUN=11
OK
```

Here is the new control line configuration. The AT interface is disabled.

```
<DSR=OFF>, RI=OFF, DCD=OFF, <CTS=OFF>, RTS=ON, DTR=ON
```

The module is in power saving, it monitors the RTS toggling every N seconds to change the current AT interface state (disabled/enabled).

Toggle RTS, the AT interface is enabled.

Check the current CFUN.

```
AT+CFUN?
+CFUN: 11
OK
```

Toggle RTS, the AT interface is disabled.

When the alarm time is expired, DTE shows the URCs only if AT interface is enabled.

Toggle RTS, the AT interface is enabled.

```
+CALA: ALARM, ALARM, ALARM
```

Check the alarm mode

```
AT#WAKE?
#WAKE: 1 ← the module is in alarm mode
OK
```

```
+CALA: ALARM, ALARM, ALARM
```

Check the current CFUN.

```
AT+CFUN?
+CFUN: 11
OK
```

```
+CALA: ALARM, ALARM, ALARM
```

After 90 sec, the module exits alarm mode.

Check the alarm mode.

AT#WAKE?

#WAKE: 0 ← the module exited alarm mode
OK

The module does not change CFUN mode.

AT+CFUN?

+CFUN: 11
OK

Toggle RTS, the module enter power saving, and the AT interface is disabled.

<**DSR=OFF**>, RI=OFF, DCD=OFF, <**CTS=OFF**>, RTS=ON, DTR=ON

4.7. GPIO Pins

Telit Modules provide various GPIO pins, which can be configured, by means of the AT commands, as showed hereafter:

- Inputs,
- Outputs,
- “Alternate Functions”.

User applications, through GPIO AT commands, can control external user equipment connected to GPIO pins. Simple or no circuitries are needed to perform the required hardware interface.



The GPIO setting is not saved on power off. At power on, repeat the GPIO setting. For detailed GPIO pins descriptions refer to document [3] in accordance with the used module.

4.7.1. Set GPIO Pin as OUTPUT

Use the following AT command to set a GPIO as output with Low or High status value.

AT#GPIO=<pin>,<value>,1

Set GPIO8 pin as Output with Low status:

AT#GPIO=8,0,1

OK ← GPIO8 pin is set in output; its status is Low

Set GPIO8 pin as Output with High status:

AT#GPIO=8,1,1

OK ← GPIO8 pin is set in output; its status is High

4.7.2. Set GPIO Pin as INPUT

Use the following AT command to set a GPIO as input. A dummy value must be specified for pin status value.

AT#GPIO=<pin>,<dummy_value>,0

Example

Set GPIO9 pin as Input:

AT#GPIO=9,0,0

OK ← GPIO9 pin is set in input

4.7.3. GPIO Pin Status

Use the following AT command to check the pin status.

AT#GPIO=<pin>,2

Set GPIO8 pin as output with Low status.

AT#GPIO=8,0,1
OK

Set GPIO9 pin as input.

AT#GPIO=9,0,0
OK

Now, physically connect GPIO8 with GPIO9, and check the GPIO9 status.

AT#GPIO=9,2
#GPIO: 0,0 ← GPIO9 pin status is Low, as commanded by GPIO8.

Set GPIO8 pin as output with High status.

AT#GPIO=8,1,1
OK

Check the GPIO9 status.

AT#GPIO=9,2
#GPIO: 0,1 ← GPIO9 pin status is High, as commanded by GPIO8.

Check the GPIO8 status.

AT#GPIO=8,2
#GPIO: 1,1

GPIO8 pin is set in Output direction and its status is High.

Check the supported range of pin, mode and direction. The command response depends on the used module.

AT#GPIO=?
#GPIO: (1-13),(0-2),(0-2)
OK



The AT command response is function of the pin direction:

- input: the command response indicates the current input status
- output: the command response indicates the last setting of the pin status

If GPIO pin is set to Alternate Function mode, the reported status is not valid.

4.7.4. GPIO & Alternate Function

The following paragraphs describe the GPIO dedicated to support the Alternate Function configuration, and the AT commands used to perform the setting. For a detailed documentation about the Alternate Functions and GPIO circuitry refer to document [3] in accordance with the used module.

4.7.4.1. GPIO4 Pin as RF Transmission Control

The user application by means of the GPIO4 can control the transmitter of the module. Use the following AT command to set the GPIO4 in RF Transmission Control Alternate Function mode.

AT#GPIO=4,<dummy_value>,2



The GPIO4 pin is set in input; the setting is saved at module power off

4.7.4.2. GPIO5 Pin as RFTXMON OUTPUT

The GPIO5 pin is provided with circuitry in order to be connected to the “RFTXMON OUTPUT”. The user application by means of the GPIO5 can monitor the transmitter module status. Use the following AT command to set the GPIO5 in “RFTXMON OUTPUT” Alternate Function mode.

AT#GPIO=5,<dummy_value>,2

Set GPIO5 pin as RFTXMON Output:

AT#GPIO=5,0,2

OK ← GPIO5 pin is successfully set in RFTXMON Output Alternate Function mode.



The GPIO5 pin is set in output; the setting is saved at module power off

4.7.4.3. GPIO6 Pin as ALARM OUTPUT

The user application through the GPIO6 can monitor the ALARM status. The AT+CALA command is used to set the ALARM working with GPIO6. Use the following AT command to set the GPIO6 pin in Alarm Output Alternate Function mode.

AT#GPIO=6,<dummy_value>,2

Set GPIO6 pin as Alarm Output:

AT#GPIO=6,0,2

OK ← GPIO6 pin is successfully set in Alarm Output Alternate Function mode.



The GPIO6 pin is set in output, the setting is saved at module power off

4.7.4.4. GPIO7 Pin as BUZZER OUTPUT

Use the following AT command to set the GPIO7 pin in Buzzer Output Alternate Function mode.

AT#GPIO=7,<dummy_value>,2

Set GPIO7 pin as Buzzer Output:

AT#GPIO=7,0,2

OK ← GPIO7 pin is successfully set in BUZZER OUTPUT Alternate Function mode.



The GPIO7 pin is set in output, the setting is saved at module power off. Use AT#SRP command to setup the needed Buzzer configuration

4.7.4.5. Set STAT_LED GPIO

The Network Service availability and Call status can be indicated through the blinking light of a led connected to a GPIO by means of a simple circuitry. The GPIO used for this function depends on the used module. This GPIO is called STAT_LED pin and can be configured using the following AT command.

Enable the function

AT#SLED=2

OK

Save the setting

AT#SLEDSAV

OK

Disable the function

AT#SLED=0

OK ← now, the GPIO is free to be used for other functions

4.7.4.6. JAM GPIO

4.7.4.6.1. 2G Modules

Jamming devices interfere with GSM communications corrupting the GSM signals. GPIO2 can be used to give information concerning the presence/absence of jamming activity in that area. The jamming activity indicator is configured by means of the following AT command. Refer to document [11] to have detailed information on the "Methods" mentioned below.

Enable GPIO2 as jamming activity indicator and select the Method 1 to evaluate the presence/absence of jamming.

AT#JDRENH=1,1

OK

Disable GPIO2 as jamming activity indicator.

AT#JDRENH=0

OK

Enable GPIO2 as jamming activity indicator and select the Method 2 to evaluate the presence/absence of jamming. To perform the evaluation using Method 2, the module must be powered on when jamming activity is not present.

AT#JDRENH=1,2

OK

Disable GPIO2 as jamming activity indicator.

AT#JDRENH=0

OK

In general, the quickness of the evaluation depends on the number of GSM frequencies that are analyzed.

4.7.4.6.2. 3G Modules

Refer to document [21].

4.8. Clock and Alarm Functions

The modules provide Real Time Clock and Alarm features. The next sub-chapters describe some examples to show the AT commands used to:

- Set up the right time
- Check the actual time
- Set up an alarm time
- Delete an alarm time

Check/Update module clock before using the Alarm feature.

Once woken up, the module can have several "alarm behaviors type" in accordance with the <type> parameter used to set up the alarm by means of the AT+CALA command:

- Automatically wakes up from shutdown and becomes operative.
- Automatically wakes up from shutdown and enters dedicated Alarm Status. The module does not look for or try to register on any network, it performs only previously programmed alarm actions. It can receive AT commands to become operative or shutdown immediately.
- Send an unsolicited code "+CALA: <text>" on the serial port until the 90 sec timeout expires or a special wake up command is received.

The programmed unsolicited code "AT+CALA:<user_text>" alerts the user application that the "alarm time" is expired.

- Play an alarm tone until the 90 sec timeout expires or a special wake up command is received. The playing of the alarm tone alerts the user.
- Rise the GPIO6 pin until the 90 sec timeout expires or a special wake up command is received. The GPIO6 pin can be used to wake up a user device at the desired time.

4.8.1. Clock

4.8.1.1. Set Module Clock

Use the following AT command to update the module clock.

AT+CCLK="<time>"

Set up the clock to 7 November 2002 at 12h 24m 30s for the time zone +01h central Europe:

```
AT+CCLK="02/11/07,12:24:30+04"
OK
```

The time is successfully set.



The updated time starts immediately after the time setting command.

4.8.1.2. Read the Current Date and Time

Use the following AT command to display the current module time.

AT+CCLK?

Read the current time:

AT+CCLK?

+CCLK="02/11/07,12:26:47"

OK

Current date/time is: 7 November 2002 12h 26m 47s

Enter the current time: year/month/day,hour:minute:seconds±time zone:

AT+CCLK="08/05/16,09:20:30+00"

OK

Read the current time:

AT+CCLK?

+CCLK: "08/05/16,09:20:52"

OK



The three last characters of <time> are not returned by the command because the used module does not support time zone information.

4.8.1.3. Automatic Data/Time updating

Use the following AT command to enables or disables the data/time updating. Not all Operators support this feature.

AT#NITZ=<val>,<mode>

Examples

AT#NITZ?

#NITZ: 7,0
OK

AT#NITZ=15,1

enable full data/time updating

OK

AT&W0

OK

AT&P0

OK

Power the module OFF/ON. After GSM registration or GPRS attach, depending on the Network Provider configuration, on the DTE appears the following unsolicited indication:

#NITZ: 10/11/30,14:36:37+04,0 ← date/time and time zone + daylight saving time

Now, type in the following commands just to make a comparison between the commands responses formats.

AT+CCLK?

+CCLK: "10/11/30, 14:36:42+04" ← date/time and time zone
OK

AT#CCLK?

#CCLK: "10/11/30, 14:36:52+04,0" ← date/time and time zone + daylight saving time
OK

4.8.2. Alarm

4.8.2.1. Set Alarm

Use the following AT command to set up the Alarm configuration:

AT+CALA="<time>",0,<type>,"<text>"

Follow these commands to set up an Alarm configuration.

Read the current time.

AT+CCLK?

+CCLK: "08/05/16,09:20:52"
OK

Set up an Alarm configuration, <type> parameter is 2.

AT+CALA="08/05/16,09:35:30+00",0,2,"ALARM, ALARM, ALARM"
OK

Read the current time.

AT+CCLK?

+CCLK: "08/05/16,09:34:04"
OK

Read the current time, the Alarm time is close.

AT+CCLK?

+CCLK: "08/05/16,09:34:49"
OK

The Alarm time is reached, the module displays on the DTE the previously configured unsolicited code:

+CALA: ALARM, ALARM, ALARM
+CALA: ALARM, ALARM, ALARM
+CALA: ALARM, ALARM, ALARM
+CALA: ALARM, ALARM, ALARM
+CALA: ALARM, ALARM, ALARM

4.8.2.2. Delete Alarm

Example 1

Follow these commands to set up and delete the Alarm using its index.

Read the current time.

AT+CCLK?

+CCLK: "08/07/18,10:17:21"
OK

Set up the Alarm configuration, the alarm index is 0.

AT+CALA="08/07/18,10:22:00+00",0,2,"NEW ALARM"

OK

Read the current time

AT+CCLK?

+CCLK: "08/07/18,10:19:04"
OK

Read the current time

AT+CCLK?

+CCLK: "08/07/18,10:19:48"
OK

The Alarm time is not reached

Delete the Alarm configuration using the alarm index.

AT+CALD=0

OK

Read the current time

AT+CCLK?

+CCLK: "08/07/18,10:22:37"

OK

The Alarm time is over, the unsolicited +CALA: NEW ALARM message is not appeared on the DTE in accordance with AT+CALD=0 command.

Example 2

Follow these commands to set up and delete the current Alarm.

Read the current time

AT+CCLK?

+CCLK: "08/07/18,10:42:31"

OK

Set up an Alarm configuration, <type> parameter is 2.

AT+CALA="08/07/18,10:48:00+00",0,2,"NEW1 ALARM"

OK

Read the current time

AT+CCLK?

+CCLK: "08/07/18,10:44:25"

OK

The Alarm time is not reached

Delete the current Alarm configuration.

AT+CALA=""

OK

Read the current time

AT+CCLK?

+CCLK: "08/07/18,10:47:02"

OK

The Alarm time is still not reached

Read the current time

AT+CCLK?

+CCLK: "08/07/18,10:48:46"

OK

The Alarm time is over, the unsolicited +CALA: NEW1 ALARM message is not appeared on the DTE in accordance with AT+CALA="" command.

4.8.2.3. Recurrent Alarm

Follow these commands to set up the recurrent Alarm configuration.

Read the current time

AT+CCLK?

+CCLK: "08/07/18,10:42:31"

OK

Set up a recurrent Alarm configuration for all days in the week

AT+CALA="11:45:00+00",0,2,"NEW2 ALARM",0

OK

Read the current time

AT+CCLK?

+CCLK: "08/07/18,11:35:25"

OK

The response shows that the Alarm time is still not reached.

The Alarm time is reached, the module displays on the DTE the previously configured unsolicited code:

+CALA: NEW2 ALARM

+CALA: NEW2 ALARM

+CALA: NEW2 ALARM

+CALA: NEW2 ALARM

+CALA: NEW2 ALARM

.

.

Exit "Alarm Activity" and enter "Normal Operating Mode"

AT#WAKE=0

OK

Set up the new day to simulate the passing of time

AT+CCLK="08/07/19,11:42:00+00

OK

Read the current time

AT+CCLK?

+CCLK: "08/07/19,11:44:25"

OK

The response shows that the Alarm time is still not reached

The Alarm time is reached, the module displays on the DTE the configured unsolicited code set up yesterday! :

+CALA: NEW2 ALARM

+CALA: NEW2 ALARM

+CALA: NEW2 ALARM

+CALA: NEW2 ALARM

.

.



The Alarm time refers to the local time, regardless the time zone set by AT+CCLK command.

If GPIO6 pin is used as ALARM OUTPUT, it must be configured in "Alternate Function" mode (see § 4.7.4.3) or else the pin will not respond to the Alarm settings.

If the unsolicited code +CALA: <text> is used, the serial port speed must be configured as needed (see § 3.2) and stored in the active profile (see AT&W command), to perform the module power on with the desired serial port speed. Be careful, at the Alarm wake up, the module will start with the default port speed that could be different from the speed set on DTE.

4.8.2.4. Postpone Alarm Time

Use the following AT command to postpone the Alarm configuration.

AT+CAPD=<time>

Read the current time

```
AT+CCLK?
+CCLK: "09/08/05,09:24:46+04"
OK
```

Set up an Alarm configuration, <type> parameter is 2.

```
AT+CALA="09/08/05,09:28:00+04",0,2,"NEW ALARM"
OK
```

Postpone of 60 seconds the just configured Alarm

```
AT+CAPD=60
OK
```

The Alarm time is reached, the module displays on the DTE the configured unsolicited code:

```
+CALA: NEW ALARM
+CALA: NEW ALARM
.
.
```

4.8.2.5. Stop Alarm

When the "Alarm Time" is reached, the module starts the "Alarm Activity" according to the previous "Alarm Setting". There are three ways to stop the "Alarm Activity".

- Shutdown the module
- Exit from "Alarm Activity" and enter the "Normal mode"
- Let the "Alarm Activity" continue until the 90 sec timeout is expired

Use the following AT command, the module exits "Alarm Activity" and shuts down.

AT#SHDN
OK

Exit from the Alarm Status and Enter the Normal mode:

Use the following AT command, the module exits "Alarm Activity" and enters "Normal mode".

AT#WAKE=0
OK

4.8.2.6. Alarm Status

When the "Alarm Time" is reached, the module wakes up and starts the "Alarm Activity". During this period no "Network Activity" is performed: the user application can perform some operations without register the module on the network. To check if the module is in the "Alarm" or in the "Normal mode" status, use the following AT command.

AT#WAKE?



When the module is in the "Alarm" mode, no network activities are allowed: it is not possible to receive or send calls, SMS and any services. The only commands that are accepted by the module are AT#WAKE and AT#SHDN.

4.8.2.7. A simple Alarm Application

In this example, it is assumed that the user is developing a Meteorological Unit using a battery-powered module. The Meteorological Unit requirement is to measure the weather conditions every hour and send an SMS message to the main server, indicating the weather status just measured. The user application should minimize the power consumption, because the Meteorological Unit will be installed in a remote location and its battery must last as long as possible. To minimize the power consumption, the user application should shut the module down as well the equipment that does not need to be powered up all the time. The module and the equipment will be woken up every hour for just the time needed to measure and send the required SMS message.

Set up the current time.

AT+CCLK="02/11/07,12:24:30+01"
OK

Set up the next alarm to program the GPIO6 pin which is responsible to power up the user equipment that does not need to be powered up all the time. <type> parameter is 6.

AT+CALA="02/11/07,13:24:30+01",0,6,"TIME TO MEASURE & SMS...!"
OK

Shut down the module and the equipment.

AT#SHDN
OK

After an hour, when the programmed alarm time is reached, the module turns itself on in "Alarm Mode", forces high the GPIO6 pin, which turns on the power supply of the equipment and sends the unsolicited code to DTE every three seconds:

+CALA: TIME TO MEASURE & SMS...!

The module recognizes the unsolicited code and forces itself in operating mode:

```
AT#WAKE=0  
OK
```

The equipment performs the weather measurements and by means of the module sends the SMS with the weather data.

Read the current time.

```
AT+CCLK?  
+CCLK="02/11/07,13:24:47"  
OK
```

Calculate and set up the next alarm time to program the GPIO6 pin which is responsible to power up the user equipment that does not need to be powered up all the time.

```
AT+CALA="02/11/07,14:24:47+01",0,6,"TIME TO MEASURE & SMS...!"  
OK
```

Shut down the module and the equipment.

```
AT#SHDN  
OK
```

The module and the equipment are powered off. This sequence is repeated every hour.

5. TCP/IP PROTOCOL

To have more information on connections topic refer to document [23].

5.1. 2G/3G Dialup Connection

The following two sub-chapters describe how to establish a dialup connection. The connection uses the following protocols:

- PPP running on the PC (or Application Equipment), and on the module
- TCP/IP running only on the PC (or Application Equipment)

5.1.1. 2G Modules

Check the current network operator.

```
AT+COPS?  
+COPS: 0,0,"network operator"  
OK
```

```
AT+WS46?  
+WS46: 12 ← 12 = GSM  
OK
```

Check the current GPRS service attachment state.

```
AT+CGATT?  
+CGATT: 1  
OK
```

Use <cid>=1 to configure the PDP context.

```
AT+CGDCONT=1,"IP","APN"  
OK
```

Type in the dialup command to enter the ONLINE Mode. By default, the command uses the <cid>=1.

```
ATD*99#  
CONNECT
```

Now, your application should start the PPP protocol, which triggers the PDP context activation. For more information, refer to documents [23]/[24].

5.1.2. 3G Modules

Check the current network operator.

AT+COPS?

+COPS: 1,0,"network operator",2 ← 2 = UTRAN
OK

AT+WS46?

+WS46: 25 ← GERAN and UTRAN
OK

Check the current module attachment state.

AT+CGATT?

+CGATT: 1
OK

Use <cid>=1 to configure the PDP context.

AT+CGDCONT=1,"IP","APN"

OK

Type in the dialup command to enter the ONLINE Mode. By default, the command uses the <cid>=1.

ATD*99#

CONNECT

Now, your application should start the PPP protocol, which triggers the PDP context activation. For more information, refer to documents [23]/[24].

5.2. 4G Modules and Default/Dedicated EPS Bearers

In GPRS and 3G networks, the data session is established by means of the Packet Data Protocol (PDP) Context procedure. Before the PDP context can be established, the module must do an Attach procedure, which communicates to the SGSN (Serving GPRS Support Node) that the module has powered up. After the Attach procedure is completed, the module can do the first PDP Context procedure that will establish the data session, and allocate an IP address to the module. This PDP Context will have a QoS associated with it based on the current needs. If the module needs to have multiple data sessions, it will do a second PDP Context activation, and so on.

In LTE (4G) modules there are two types of data session setups.

- **Default Evolved Packet System (EPS) Bearer.**
When UE attaches to the network for the first time, it will be assigned default bearer that remains as long as UE is attached. UE can have additional default bearers as well. Each default bearer comes with a separate IP address. Default bearer does not have specific QoS (non-GBR bearer).
- **Dedicated Evolved Packet System (EPS) Bearer.**
It is created when the requested service cannot be fulfilled through default bearer. Some services require a high level of QoS like VoIP, video etc. Therefore, network creates a dedicated bearer with required QoS (can be GBR or non-GBR). Dedicated bearer does not require separate IP address, only additional default bearer needs an IP address and therefore dedicated bearer is always linked to one of the default bearer established previously.

To have information on AT commands syntax and related parameters refer to document [26].

5.2.1. Default EPS Bearer at UE Power on

*Example***Power on a LE910-V2 module (4G).**

By default, the <p_cid>=1 context identifier is assigned to a not defined APN.

```
AT+CGDCONT?  
+CGDCONT: 1,"IPV4V6","", "",0,0  
OK
```

When the network recognizes the attach request with a not defined APN, the network assigns to <p_cid>=1 its Default EPS Bearer. The UE is 4G attached.

```
AT+CGATT?  
+CGATT: 1  
OK
```

After the Attach procedure, the <p_cid>=1 identifies the PDP context assigned by the network.

```
AT+CGACT?  
+CGACT: 1,1  
OK
```

Power on a GE910-QUAD module (2G).

The <cid>=1 context identifier is not assigned by default.

```
AT+CGDCONT?  
OK
```

The module is GPRS attached.

```
AT+CGATT?  
+CGATT: 1  
OK
```

After the attached procedure, no PDP Contexts are active.

```
AT+CGACT?  
OK
```

LE910-V2 module (con't)

List the parameters regarding the Default PDP Context assigned by the network, and associated to <p_cid>=1 context identifier.

```

AT+CGCONTRDP=1
+CGCONTRDP:
1,                p_cid
5,                bearer_id
"lte.tim.it.mnc001.mcc222.gprs",  apn
"10.178.43.36.255.0.0.0",        ip_addr and subnet_mask
"10.178.43.37",                gw_addr
"213.230.129.10",             DNS_prim_addr
"0.0.0.0",                    DNS_sec_addr
"0.0.0.0",                    P_CSCF_prim_addr
"0.0.0.0",                    P_CSCF_sec_addr
OK

```



The functionalities (Data, IMS) of the Default PDP context assigned by the network, depend on the Network Operator.

When the <p_cid>=1 is associated to a user APN, i.e. the APN is not empty, that APN is used by the module during the 4G registration and data connection procedures. Some Network Operators could not allow the 4G registration when the user APN is used, and they could force a detach. If this happens, it is recommended to set the user APN on a <p_cid> different from 1 and keep on <p_cid> 1 the empty APN.

5.2.1.1. Change a Default EPS Bearer at UE Power on

Following these steps, you can substitute the Default EPS Bearer with a user PDP Context.

Set up the new PDP Context associated to <p_cid>=1.

```

AT+CGDCONT=1,"IP","ibox.tim.it"
OK

```

Check the setting of the new PDP Context.

```

AT+CGDCONT?
+CGDCONT: 1,"IP","ibox.tim.it","",0,0
OK

```

Detach the UE from the network.

```

AT+CGATT=0
OK

```

Attach the UE. In a 4G network, the new PDP Context associated to <p_cid>=1 is automatically activated.

```

AT+CGATT=1
OK

```

List the parameters regarding the new Default EPS Bearer set and activated by the user.

AT+CGCONTRDP=1

+CGCONTRDP:

1,	p_cid
5,	bearer_id
"ibox.tim.it.mnc001.mcc222.gprs",	apn
"2.192.4.65.255.0.0.0",	ip_addr and subnet_mask
"2.192.4.66",	gw_addr
"10.207.43.46",	DNS_prim_addr
"0.0.0.0",	DNS_sec_addr
"0.0.0.0",	P_CSCF_prim_addr
"0.0.0.0"	P_CSCF_sec_addr

OK

The UE saves the Default EPS Bearer parameters in NVM. At each reboot, the Protocol Stack uses them.

Now, reboot the module and verify the PDP Context.

AT+CGDCONT?

+CGDCONT: 1,"IP","ibox.tim.it","",0,0

OK

5.2.2. Establish a Default EPS Bearer

The following AT commands can establish a Default EPS Bearer:

- **AT+CGACT**
Establishes a Default EPS Bearer. If the module (UE) is not attached, it does the Attached procedure and then activates the PDP Context.
- **AT#SGACT**
Establishes a Default EPS Bearer, and opens a Network Interface to use the TCP/IP protocol running on the UE (IP Easy connection, see document [4]). If the <cid> used by the AT#SGACT command is already active, the command opens only a Network Interface.
- **ATD**
Establishes a Default EPS Bearer. It provides a dialup connection: PPP protocol is used to exchange data between the PC (or Application Equipment) and the module (UE), the TCP/IP stack is running on the module.
- **AT#NCM**
Establishes a Default EPS Bearer, refer to chapter 5.2.6
- **AT#MBIMCFG**
Refer to document [23].



The AT commands shown in this chapter cannot use together the same <cid>.

5.2.3. Dedicated EPS Bearer

TBD

5.2.4. AT#DUALAPN

Assume that the UE is registered on a 4G network. If the UE tries to establish two Default EPS bearers with the same APN and PDP type, the second PDN Connectivity Request returns an ERROR message. In general, some 4G Network Operators does not support multiple Default EPS bearers for a single APN.

This could be a limitation for those user applications requiring the activation of two PDP contexts connected to two different <p_cid>.

To overcome this limitation, use the #DUALAPN=0 mode that allows you, for example, to assign to <p_cid>=2 the same APN and PDP type already in use with <p_cid>=1. The module routes the <p_cid>=2 to the <p_cid>=1; therefore, the IP address of both <p_cid> will be the same. See the examples in the following sub-chapters.



- I. If the module is in #DUALAPN=0 mode, the AT commands shown in chapter 5.2.2 cannot use two <p_cid> having the same IP address.
 - II. #DUALAPN=0 mode is by default.
-

5.2.4.1. IP Easy Connection

Example 1

Assume that the Default EPS Bearer associated to the <p_cid>=1 is "IP", "ibox.tim.it", and no other Default EPS Bearers are defined.

AT+CGDCONT?

```
+CGDCONT: 1,"IP","ibox.tim.it","",0,0
OK
```

Check if the UE is registered on a 4G network.

AT+COPS?

```
+COPS: 0,0,"I TIM",7          ← 7 = E-UTRAN
OK
```

Check if the Default EPS Bearer is active

AT+CGCONTRDP=?

```
+CGCONTRDP: (1)
OK
```

Force the UE in #DUALAPN=0 mode (default).

AT#DUALAPN=0

```
OK
```

For example, if you assign to <p_cid>=2 the same APN and PDP type already in use by <p_cid>=1, the <p_cid>=2 is routed to the <p_cid>=1.; therefore, the IP address of both <p_cid>s will be the same, as shown below.

```
AT+CGDCONT=2,"IP","ibox.tim.it"
OK
```

```
AT+CGDCONT?
+CGDCONT: 1,"IP","ibox.tim.it","",0,0
+CGDCONT: 2,"IP","ibox.tim.it","",0,0
OK
```

Only the first context is active.

```
AT+CGPADDR=
+CGPADDR: 1,"2.192.16.194"
+CGPADDR: 2,""
OK
```

Activate the second context.

```
AT#SGACT=2,1
#SGACT: 2.192.16.194
OK
```

The command returns the error code identifying the network reject cause. If no error, the code is 0.

```
AT#CEERNET
#CEERNET: 0
OK
```

As stated before, both <p_cid> have the same IP address.

```
AT+CGPADDR=
+CGPADDR: 1,"2.192.16.194"
+CGPADDR: 2,"2.192.16.194"
OK
```

Example 2

Assume that the Default EPS Bearer associated to the <p_cid>=1 is "IP","ibox.tim.it", and no other Default EPS Bearers are defined.

```
AT+CGDCONT?
+CGDCONT: 1,"IP","ibox.tim.it","",0,0
OK
```

Check if the UE is registered on a 4G network.

```
AT+COPS?
+COPS: 0,0,"I TIM",7          ← 7 = E-UTRAN
OK
```

Check if the Default EPS Bearer is active

```
AT+CGCONTRDP=?
+CGCONTRDP: (1)
OK
```

Force the UE in #DUALAPN=1 mode.

AT#DUALAPN=1

OK

Assigns to <p_cid>=2 the APN and PDP type associated to <p_cid>=1 already in use.

AT+CGDCONT=2,"IP","ibox.tim.it"

OK

AT+CGDCONT?

+CGDCONT: 1,"IP","ibox.tim.it","",0,0

+CGDCONT: 2,"IP","ibox.tim.it","",0,0

OK

Only the first context is active.

AT+CGPADDR=

+CGPADDR: 1,"2.192.16.194"

+CGPADDR: 2,""

OK

Enable ERROR report in verbose format.

AT+CMEE=2

OK

Activate the second context. When a PDN Connectivity Request is sent, the command return an ERROR.

AT#SGACT=2,1

+CME ERROR: activation failed

The command returns the error code identifying the network reject cause.

AT#CEERNET

#CEERNET: 55

OK

AT+CGPADDR=

+CGPADDR: 1,"2.192.16.194"

+CGPADDR: 2,""

OK

5.2.4.2. Dialup Connection

Example

Use COM1 port to enter the next commands, and assume that the Default EPS Bearer associated to the <p_cid>=1 is "IP", "ibox.tim.it", and no other Default EPS Bearers are defined.

AT+CGDCONT?

```
+CGDCONT: 1,"IP","ibox.tim.it","",0,0
OK
```

Check if the UE is registered on a 4G network.

AT+COPS?

```
+COPS: 0,0,"I TIM",7          ← 7 = E-UTRAN
OK
```

Check if the Default EPS Bearer is active

AT+CGCONTRDP=?

```
+CGCONTRDP: (1)
OK
```

Force the UE in #DUALAPN=0 mode (default).

AT#DUALAPN=0

```
OK
```

For example, if you assigns to <p_cid>=2 the APN and PDP type associated to <p_cid>=1 already in use, the <p_cid>=2 is routed to the <p_cid>=1. Therefore, the IP address will be the same for both <p_cid> as shown by the following commands.

AT+CGDCONT=2,"IP","ibox.tim.it"

```
OK
```

AT+CGDCONT?

```
+CGDCONT: 1,"IP","ibox.tim.it","",0,0
+CGDCONT: 2,"IP","ibox.tim.it","",0,0
OK
```

Only the first context is active.

AT+CGPADDR=

```
+CGPADDR: 1,"2.192.16.194"
+CGPADDR: 2,""
OK
```

For example, type in **AT#PORTCFG=3** command, and reboot the UE.

After rebooting, use COM2 port to start a dialup connection from AT2 instance.

Enter the following command to force the UE in the ONLINE Mode. The command uses the <cid>=2.

```
ATD*99***2#
CONNECT
```

Now, your application should start the PPP protocol. For more information, refer to documents [23]/[24].

Use COM1 port to enter the next command.

If the PPP activation is successful, the two context identifiers have the same IP address, as stated before.

```
AT+CGPADDR=
+CGPADDR: 1,"2.192.16.194"
+CGPADDR: 2,"2.192.16.194"
OK
```

5.2.5. AT#PDPAUTH

Power on the UE. By default, the <p_cid>=1 context identifier is assigned to the following not defined PDP context.

```
AT+CGDCONT?
+CGDCONT: 1,"IPV4V6", "", "", 0,0
OK
```

When the 4G network recognizes the attach request with a not defined PDP context, the network assigns to <p_cid>=1 its Default EPS Bearer. The UE is 4G attached

```
AT+CGCONTRDP=1
+CGCONTRDP:
1,
5,
"internet.proximus.be.mnc001.mcc206.gprs",
"100.80.28.204.255.0.0.0","100.80.28.205",
"80.201.237.239",
"0.0.0.0","0.0.0.0",
"0.0.0.0"
OK
```

Set up the new PDP Context associated to <p_cid>=1.

```
AT+CGDCONT=1,"IPV4V6","AccessPointName"
OK
```

Verify the entered PDP Context.

```
AT+CGDCONT?
+CGDCONT: 1,"IPV4V6","AccessPointName", "", 0,0
OK
```

Set the PDP authentication parameters.

```
AT#PDPAUTH=1,1,"UserName","PassWord"
OK
```

Detach the UE from the network.

AT+CGATT=0

OK

Attach the UE to the network, the new PDP Context is activated. It is the new Default EPS Bearer.

AT+CGATT=1

OK

List the parameters regarding the new Default EPS Bearer set and activated by the user.

AT+CGCONTRDP=1

+CGCONTRDP:

1,

5,

"AccessPointName.mnc001.mcc206.gprs",

"10.113.0.66.255.0.0.0",

"10.113.0.67","8.8.4.4",

"0.0.0.0","0.0.0.0",

"0.0.0.0"

OK



If you use the AT#PDPAUTH command, and then use, for example, the AT#NCM command to activate the PDP context with new authentication parameters, the authentication process is performed using the last entered parameters.

5.2.6. AT#PDPAUTH & AT#NCM

This chapter describes the use of AT#PDPAUTH and AT#NCM commands. Refer to document [25] to get information about the AT#NCM command.

Example 1

Power on the UE.

By default, the <p_cid>=1 context identifier is assigned to a not defined APN.

AT+CGDCONT?

+CGDCONT: 1,"IPV4V6",,"",0,0

OK

When the 4G network recognizes the attach request with a not defined APN, the network assigns to <p_cid>=1 its Default EPS Bearer, and the UE is 4G attached

AT+CGCONTRDP=1

+CGCONTRDP:

1,
5,
"internet.proximus.be.mnc001.mcc206.gprs",
"100.80.28.204.255.0.0.0","100.80.28.205",
"80.201.237.239",
"0.0.0.0","0.0.0.0",
"0.0.0.0"
OK

Set up the new PDP Context associated to <p_cid>=1.

AT+CGDCONT=1,"IPV4V6","AccessPointName"

OK

Verify the entered PDP Context.

AT+CGDCONT?

+CGDCONT: 1,"IPV4V6","AccessPointName","",0,0
OK

Use <cid>=1, and set the PDP authentication parameters.

AT#PDPAUTH=1,1,"UserName","PassWord"

OK

Detach the UE from the network.

AT+CGATT=0

OK

Attach the UE. In a 4G network, the PDP Context associated to <p_cid>=1 is automatically activated.

AT+CGACT=1,1

OK

Verify the state of the PDP Context.

AT+CGACT?

+CGACT: 1,1
OK

List the parameters regarding the new Default EPS Bearer set and activated by the user.

AT+CGCONTRDP=1

+CGCONTRDP:

1,
5,
"AccessPointName.mnc001.mcc206.gprs",
"10.113.0.66.255.0.0.0",
"10.113.0.67",
"8.8.4.4",
"0.0.0.0",
"0.0.0.0",
"0.0.0.0"
OK

Assign the NCM protocol to cid = 1.

```
AT#NCM=1,1
OK
```

Activate the NCM protocol on USB0, refer to document [25].

```
AT+CGDATA="M-RAW_IP",1
CONNECT
OK
```

Example 2

Power on the UE.

By default, the <p_cid>=1 context identifier is assigned to a not defined APN.

```
AT+CGDCONT?
+CGDCONT: 1,"IPV4V6","","",0,0
OK
```

When the 4G network recognizes the attach request with a not defined APN, the network assigns to <p_cid>=1 its Default EPS Bearer, and the UE is 4G attached

```
AT+CGCONTRDP=1
+CGCONTRDP:
1,
5,
"internet.proximus.be.mnc001.mcc206.gprs",
"100.87.125.10.255.0.0.0",
"100.87.125.11",
"80.201.237.239",
"0.0.0.0","0.0.0.0",
"0.0.0.0"
OK
```

Set up the new PDP Context associated to <p_cid>=3.

```
AT+CGDCONT=3,"IPV4V6","AccessPointName"
OK
```

Use <cid>=3, and set the PDP authentication parameters.

```
AT#PDPAUTH=3,1,"UserName","PassWord"
OK
```

Detach the UE from the network.

```
AT+CGATT=0
OK
```

Verify if the UE is detached.

```
AT+CGATT?
+CGATT: 0
OK
```

Verify the state of the PDP contexts.

AT+CGACT?

+CGACT: 1,0
 +CGACT: 3,0
 OK

Attach the UE. In a 4G network, the PDP Context associated to <p_cid>=1 is automatically activated.

AT+CGATT=1,1

OK

Verify the state of the PDP Contexts.

AT+CGACT?

+CGACT: 1,1
 +CGACT: 3,0
 OK

Activate the PDP Context associated to <p_cid>=3.

AT+CGACT=1,3

OK

Verify the state of the PDP Contexts.

AT+CGACT?

+CGACT: 1,1
 +CGACT: 3,1
 OK

List the parameters regarding the Default EPS Bearers, the first one set by the 4G network, the second one set by the user.

AT+CGCONTRDP=

+CGCONTRDP:

1,
 5,
 "internet.proximus.be.mnc001.mcc206.gprs",
 "100.114.19.108.255.0.0.0",
 "100.114.19.109",
 "80.201.237.239",
 "0.0.0.0",
 "0.0.0.0",
 "0.0.0.0"

+CGCONTRDP:

3,
 6,
 "AccessPointName.mnc001.mcc206.gprs",
 "10.113.0.66.255.0.0.0",
 "10.113.0.67",
 "8.8.4.4",
 "0.0.0.0",
 "0.0.0.0",
 "0.0.0.0"

OK

Assign the NCM protocol to cid = 3.

```
AT#NCM=1,3  
OK
```

Activate the NCM protocol on USB0, refer to document [25].

```
AT+CGDATA="M-RAW_IP",3  
CONNECT  
OK
```

6. FIRMWARE UPDATE TOOL

Telit Modules support the Over-The-Air (OTA) update that is the wireless delivery of new firmware to the modules.

In the case the user needs to perform the firmware upgrading by means a serial line, Telit provides the suitable tool. It is suggested to provide a serial interface on the user printed circuit board (on which Telit Module is soldered) to perform the physical connection between the module and Windows-PC, or use the Telit Evaluation Kit (EVK2), refer to document [6], that is equipped with serial interfaces.

The following paragraphs describe the Telit tool.



GT terminals are completely cased modems (refer to Applicability Table) and provide the standard RS-232 port that can be used to perform firmware update.

6.1. Xpf tool

The Xfp tool, running on Windows-PC, allows the user to update the firmware of the module. The tool erases the flash memory content, and then downloads the new firmware on the erased flash memory.

6.1.1. Update Procedure

Here is the procedure to update the firmware:

- 1) Install on the Windows-PC the Xfp tool and the USB FLASH driver.
- 2) Power OFF the module.
- 3) Run Xfp tool. The following Xpf info appears. The info shows some products that are out of the scope of the present document.

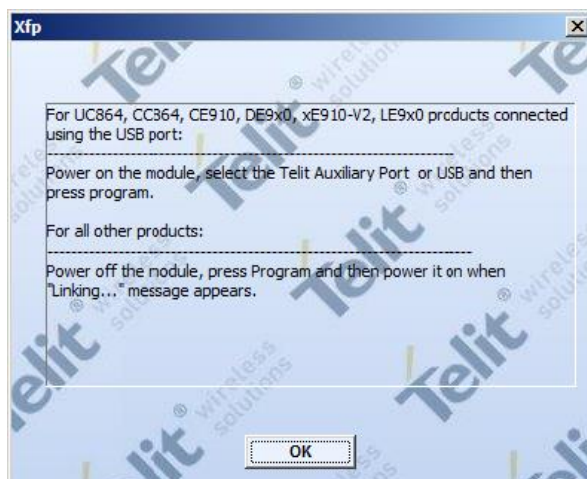

- 4) Click left on OK button. The following dialog box appears.
- 5) Select port, speed and .bin file to download in the flash memory. The tool displays the Software Version and the Product Name according to the selected .bin file.

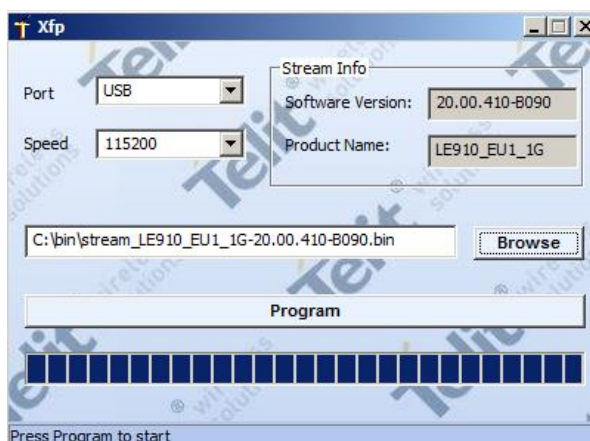

- 6) Click left Program button. The bar starts flashing.
- 7) Power ON the module, the downloading starts and the bar shows the progress of the downloading as shown by the next dialog box.

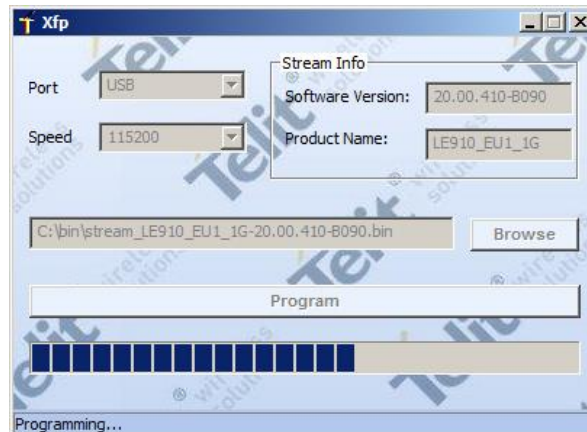

8) When the firmware update is finished, the following window appears.



6.1.1.1. Command Line running Xfp tool

The Telit Module Firmware Upgrade Procedure can be performed by means of a command line running the Xfp tool in MS-DOS environment. The command line uses a space between two consecutive parameters.

```
Xfp stream_file port speed [autoterminate] [linktimeout]<CR>
```

Where:

Xfp	tool described on paragraph 6.1.1;
stream_file	file that must be downloaded (full path);
port	COM1, COM2, ..., according to the PC configuration;
speed	9600, ..., according to the PC configuration;
autoterminate	0: Xfp doesn't exit at the downloading end, regardless of the result of the just performed activity (default); 1: the Xfp exits at the downloading end, regardless of the result of the just performed activity; 2: before closing, Xfp shows a popup with the time needed for programming;
linktimeout	Suggested range: 5 ÷ 60 [sec]. Default value = 60 [sec]. If linktimeout is used, must be used also autoterminate parameter.

Exit Codes:

0	OK
4	stream not found
5	can't open port
-4	link failure
-9	timeout / error
-11	speed error

Exit Codes are displayed when Xfp tool is closed.



The folder where is installed the Xfp tool contains a .txt file giving information on the command line running the tool. In addition, the text file contains information on the bugs fixed by the various Xfp versions.

The following VBScript example can be used to avoid the manual entry of the parameters as previously described.

```
'=====
'
'      TELIT COMMUNICATIONS S.P.A
'      VBScript Source File Name: XfpDOS.VBS
'      14th June 2010
'=====

Dim WshShell
Dim oExec
Set WshShell = CreateObject("WScript.Shell")
Command = "c:\Program\Telit\xfp\Xfp.exe D:\Stream\streamGE865_10.00.003.bin COM2
115200 0 60"
WScript.Echo "Start: " & Now()
WScript.Echo "Executing: " & Command
Set oExec = WshShell.Exec(Command)
Do While oExec.Status = 0
    WScript.Sleep 100
Loop
WScript.Echo "ExitCode: " & oExec.ExitCode
WScript.Echo "Stop: " & Now()
WScript.Quit
'=====
```

Follow these steps to run the XfpDOS.VBS script:

- 1) Enter MS-DOS environment
- 2) Enter the command : CSCRIPT XfpDOS.VBS <CR>

7. GLOSSARY AND ACRONYMS

APN	Access Point Name
BCCH	Broadcast Control Channel
CSD	Circuit Switched Data
CTM	Cellular Text Telephone Modems
CTS	Clear To Send
DCE	Data Circuit-Terminating Equipment (refer to [14])
DRX	Discontinuous Reception
DTE	Data Terminal Equipment (refer to [14])
DTMF	Dual Tone Multiple Frequency
DTR	Data Terminal Ready
GBR	Guaranteed Bit Rate
GERAN	GSM EDGE Radio Access Network
GPIO	General Purpose Input/Output
GUI	Graphic User Interface
HF	Hands Free (old terminology)
HS	Hand Set (old terminology)
HSPA	High Speed Packet Access
IMS	IP Multimedia Subsystem
IRA	International Reference Alphabet
ME	Mobile Equipment
MSISDN	Mobile Station International Subscriber Directory Number
NMEA	National Marine Electronics Association
NVM	Non-Volatile Memory
PDN	Public Data Network
PDP	Packet Data Protocol
PDU	Protocol Data Unit
PIN	Personal Identification Number
PPP	Point to Point Protocol
QoS	Quality of Service
SIM	Subscriber Identification Module

SMS	Short Message Service
SMSC	Short Message Service Center
TCP/IP	Transmission Control Protocol / Internet Protocol
TTY	Text Telephone Typewriter
UART	Universal Asynchronous Receiver Transmitter
UE	User Equipment
URC	Unsolicited Result Code
USIM	Universal Subscriber Identification Module
UTRAN	Universal Terrestrial Radio Access Network

8. DOCUMENT HISTORY

Revision	Date	Changes
7	2011-11-23	The present release supersedes all previous releases. The document has been reorganized in several parts.
8	2012-02-14	Modified chapter 4.1.1
9	2012-03-12	Updated Applicability table and Tab. 4 chapters: 3.6, 2.1, 2.16, 2.5, 3.2, 3.5.1, 2.10.5, 1.4, 2.11.5, 2.10.6
10	2012-03-26	Added GE910-QUAD to applicability table Added notes on the AT commands covered table at pag.3
11	2012-07-03	Updated notes about the GE910-QUAD (13.00.xx2). Rearrangement of the Hand Set and Hand Path Commands chapters. Updated Applicability Table Rearrangement of the chapter 2.11.7
12	2013-02-07	Updated Applicability Table: dropped out products having software version: 07.xx.xxx, added products GL865-DUAL V3 and GL868-DUAL V3 (16.xx.xxx); updated software versions of the products. Review of the chapters: 2, 2.1, 2.5, 2.6, 2.10.6, 2.11.7.1, 2.12.2, 2.16, 3.5.1, 3.6, 3.7.4, 3.8.1. Added chapter: 2.12.11.
13	2013-02-14	Added a note about GE910-QUAD in chapter 2.1..
14	2013-09-11	Products added: GE910-GNSS/13.00.xx4 GE910-QUAD V3/16.00.xx3 UE910-EUR/12.00.xx4 UE910-EUD/12.00.xx4 UE910-NAR/12.00.xx4 UE910-NAD/12.00.xx4

Revision	Date	Changes
		GL865-DUAL V3/16.00.xx2 GL865-QUAD V3/16.00.xx3 GL868-DUAL V3/16.00.xx2
15	2014-03-06	Products added: GE910-QUAD AUTO / 13.00.xx4 GE866-QUAD / 16.00.xx3 UL865-EUR/EUD / 12.00.xx4 UL865-NAR/NAD / 12.00.xx4 UL865-N3G / 12.00.xx4
16	2014-09-09	Chapter 3.6: added CFUN 10, and 11
17	2015-02-24	Chapter 3.6: added a note about transition from CFUN 10/11 to CFUN 1
18	2015-05-08	Products added: UE910 – N3G / 12.00.xx6 UE866 – N3G / 12.00.xx6 HE910 – GL / 12.00.xx6 Product removed: HE910 – GA / 12.00.xx4 Chapter 2.5: added the baud rate 230400, 460800, 921600 for 3G modules.
19	2017-01-25	A new document format has been used and the entire document has been revised. Power Saving chapter has been modified. TCP/IP chapter (focusing on Default/Dedicated EPS Bearers, LE910 V2 series modules) has been added. Firmware Update Tool chapter has been updated.
20	2017-05-02	Revision of chapters and pages numbering.



SUPPORT INQUIRIES

Link to www.telit.com and contact our technical support team for any questions related to technical issues.

www.telit.com



Telit Communications S.p.A.
Via Stazione di Prosecco, 5/B
I-34010 Sgonico (Trieste), Italy

Telit Wireless Solutions Inc.
3131 RDU Center Drive, Suite 135
Morrisville, NC 27560, USA

Telit Wireless Solutions Ltd.
10 Habarzel St.
Tel Aviv 69710, Israel

Telit IoT Platforms LLC
5300 Broken Sound Blvd, Suite 150
Boca Raton, FL 33487, USA

Telit Wireless Solutions Co., Ltd.
8th Fl., Shinyoung Securities Bld.
6, Gukjegeumyung-ro8-gil, Yeongdeungpo-gu
Seoul, 150-884, Korea

Telit Wireless Solutions
Tecnologia e Servicos Ltda
Avenida Paulista, 1776, Room 10.C
01310-921 São Paulo, Brazil

Telit reserves all rights to this document and the information contained herein. Products, names, logos and designs described herein may in whole or in part be subject to intellectual property rights. The information contained herein is provided "as is". No warranty of any kind, either express or implied, is made in relation to the accuracy, reliability, fitness for a particular purpose or content of this document. This document may be revised by Telit at any time. For most recent documents, please visit www.telit.com

Copyright © 2016, Telit

Mod. 0815