



Digi XBee3[®] Cellular LTE Cat 1

Smart Modem

User Guide

Revision history—90002253

Revision	Date	Description
A	January 2018	Initial release of the document.
B	February 2018	Added instructions for sending an SCI request to Remote Manager. Added details on SPI operation. Added antenna keepout area for Bluetooth. Updated specifications for Bluetooth.
C	June 2018	0B software release. Added file system and TLS sections, AT commands and related changes.
D	August 2018	Updated list of cipher suites. Updated Get Started section.

Trademarks and copyright

Digi, Digi International, and the Digi logo are trademarks or registered trademarks in the United States and other countries worldwide. All other trademarks mentioned in this document are the property of their respective owners.

© 2018 Digi International Inc. All rights reserved.

Disclaimers

Information in this document is subject to change without notice and does not represent a commitment on the part of Digi International. Digi provides this document “as is,” without warranty of any kind, expressed or implied, including, but not limited to, the implied warranties of fitness or merchantability for a particular purpose. Digi may make improvements and/or changes in this manual or in the product(s) and/or the program(s) described in this manual at any time.

Warranty

To view product warranty information, go to the following website:

www.digi.com/howtobuy/terms

Send comments

Documentation feedback: To provide feedback on this document, send your comments to techcomm@digi.com.

Customer support

Digi Technical Support: Digi offers multiple technical support plans and service packages to help our customers get the most out of their Digi product. For information on Technical Support plans and pricing, contact us at +1 952.912.3444 or visit us at www.digi.com/support.

Contents

Digi XBee3 Cellular LTE Cat 1 Smart Modem User Guide

Applicable firmware and hardware	11
SIM cards	11

Get started with the XBee Smart Modem Development Kit

Identify the kit contents	13
Connect the hardware	14
XBIB-U-DEV reference	16
Cellular service	17
Configure the device using XCTU	18
Add a device	18
Check for cellular registration and connection	19
Update to the latest firmware	19

Connection examples

Connect to the Echo server	22
Debugging	23
Connect to the ELIZA server	24
Debugging	25
Connect to the Daytime server	26
Debugging	27
Send an SMS message to a phone	28
Debugging	29
Perform a (GET) HTTP request	30
Debugging	31
Get started with CoAP	32
CoAP terms	32
CoAP quick start example	32
Configure the device	33
Example: manually perform a CoAP request	33
Example: use Python to generate a CoAP message	34
Connect to a TCP/IP address	37
Debugging	37
Get started with MQTT	39
Example: MQTT connect	39
Send a connect packet	41
Example: send messages (publish) with MQTT	42
Example: receive messages (subscribe) with MQTT	43

Use MQTT over the XBee Cellular Modem with a PC	44
Software libraries	47

Get started with MicroPython

About MicroPython	48
Why use MicroPython	48
MicroPython on the XBee Smart Modem	48
Use XCTU to enter the MicroPython environment	49
Use the MicroPython Terminal in XCTU	49
Troubleshooting	49
Example: hello world	50
Example: turn on an LED	50
Example: code a request help button	51
Enter MicroPython paste mode	51
Catch a button press	52
Send a text (SMS) when the button is pressed	53
Add the time the button was pressed	54
Exit MicroPython mode	55
Other terminal programs	55
Tera Term for Windows	56
Use picocom in Linux	57

Technical specifications

Interface and hardware specifications	60
RF characteristics	60
Networking specifications	60
Power requirements	60
Power consumption	61
Electrical specifications	61
Regulatory approvals	62

Hardware

Mechanical drawings	64
Pin signals	64
Pin connection recommendations	65
RSSI PWM	66
SIM card	66
The Associate LED	66

Antenna recommendations

Antenna connections	69
Keepout area	70
Through-hole keepout	71
Antenna placement	71

Design recommendations

Cellular component firmware updates	73
-------------------------------------------	----

USB Direct design	73
Power supply considerations	73
Recommended application circuit	74
Heat considerations and testing	74
Heat sink guidelines	75
Add a fan to provide active cooling	76

Cellular connection process

Connecting	78
Cellular network	78
Data network connection	78
Data communication with remote servers (TCP/UDP)	78
Disconnecting	78
SMS encoding	79

Modes

Select an operating mode	81
Transparent operating mode	82
API operating mode	82
Bypass operating mode	82
Enter Bypass operating mode	82
Leave Bypass operating mode	83
Restore cellular settings to default in Bypass operating mode	83
USB direct mode	83
Enable USB direct mode	83
Command mode	83
Enter Command mode	84
Troubleshooting	84
Send AT commands	84
Response to AT commands	85
Apply command changes	85
Make command changes permanent	85
Exit Command mode	85
MicroPython mode	86

Sleep modes

About sleep modes	88
Normal mode	88
Pin sleep mode	88
Cyclic sleep mode	88
Cyclic sleep with pin wake up mode	88
Connected sleep mode	88
The sleep timer	89
MicroPython sleep behavior	89

Power saving features

Airplane mode	91
---------------------	----

Serial communication

Serial interface	93
Serial data	93
UART data flow	93
Serial buffers	93
CTS flow control	94
RTS flow control	94
Enable UART or SPI ports	94

SPI operation

SPI communications	96
Full duplex operation	97
Low power operation	98
Select the SPI port	98
Force UART operation	99
Data format	99

File system

Overview of the file system	101
Directory structure	101
Paths	101
Secure files	101
XCTU interface	102
Encrypt files	102

Socket behavior

Supported sockets	104
Socket timeouts	104
Socket limits in API mode	104
Enable incoming TCP connections	104
API mode behavior for outgoing TCP and SSL connections	105
API mode behavior for outgoing UDP data	105
API mode behavior for incoming TCP connections	105
API mode behavior for incoming UDP data	106
Transparent mode behavior for outgoing TCP and SSL connections	106
Transparent mode behavior for outgoing UDP data	107
Transparent mode behavior for incoming TCP connections	107
Transparent mode behavior for incoming UDP connections	107

Transport Layer Security (TLS)

TLS AT commands	109
Transparent mode and TLS	110
API mode and TLS	110
Key formats	110
Certificate formats	110
Certificate limitations	110
Cipher suites	110

Server Name Indication (SNI)	111
------------------------------------	-----

AT commands

Special commands	113
AC (Apply Changes)	113
FR (Force Reset)	113
RE command	113
WR (Write)	113
Cellular commands	114
PH (Phone Number)	114
S# (ICCID)	114
IM (IMEI)	114
MN (Operator)	114
MV (Modem Firmware Version)	115
DB (Cellular Signal Strength)	115
AN (Access Point Name)	115
CP (Carrier Profile)	115
OA (Operating APN)	116
AM (Airplane Mode)	116
DV (Antenna Diversity)	116
Network commands	117
IP (IP Protocol)	117
TL (SSL/TLS Protocol Version)	117
\$0 (SSL/TLS Profile 0)	118
\$1 (SSL/TLS Profile 1)	118
\$2 (SSL/TLS Profile 2)	118
TM (IP Client Connection Timeout)	119
TS (IP Server Connection Timeout)	119
DO (Device Options)	119
EQ (Remote Manager FQDN)	120
Addressing commands	120
SH (Serial Number High)	120
SL (Serial Number Low)	120
MY (Module IP Address)	120
P# (Destination Phone Number)	121
N1 (DNS Address)	121
N2 (DNS Address)	121
DL (Destination Address)	121
OD (Operating Destination Address)	122
DE (Destination Port)	122
C0 (Source Port)	122
LA (Lookup IP Address of FQDN)	122
Serial interfacing commands	123
BD (Baud Rate)	123
NB (Parity)	123
SB (Stop Bits)	124
RO (Packetization Timeout)	124
TD (Text Delimiter)	124
FT (Flow Control Threshold)	125
AP (API Enable)	125
I/O settings commands	125
D0 (DIO0/AD0)	125
D1 (DIO1/AD1)	126
D2 (DIO2/AD2)	126

D3 (DIO3/AD3)	127
D4 (DIO4)	127
D5 (DIO5/ASSOCIATED_INDICATOR)	128
D6 (DIO6/RTS)	128
D7 (DIO7/CTS)	129
D8 (DIO8/SLEEP_REQUEST)	129
P0 (DIO10/PWM0 Configuration)	130
P1 (DIO11/PWM1 Configuration)	130
P2 (DIO12 Configuration)	131
P3 (DIO13/DOUT)	131
P4 (DIO14/DIN)	132
PD (Pull Direction)	132
PR (Pull-up/down Resistor Enable)	132
M0 (PWM0 Duty Cycle)	133
I/O sampling commands	133
TP (Temperature)	134
IS (Force Sample)	134
Sleep commands	135
SM (Sleep Mode)	135
SP (Sleep Period)	135
ST (Wake Time)	135
SO (Sleep Options)	136
Command mode options	136
CC (Command Sequence Character)	136
CT (Command Mode Timeout)	136
CN (Exit Command mode)	137
GT (Guard Times)	137
MicroPython commands	137
PS (Python Startup)	137
PY (MicroPython Command)	138
Firmware version/information commands	138
VR (Firmware Version)	139
VL (Verbose Firmware Version)	139
HV (Hardware Version)	139
AI (Association Indication)	139
HS (Hardware Series)	140
CK (Configuration CRC)	140
Diagnostic interface commands	140
DI (Remote Manager Indicator)	140
CI (Protocol/Connection Indication)	141
Execution commands	143
NR (Network Reset)	143
!R (Modem Reset)	143
File system commands	143
Error responses	144
ATFS (File System)	144
ATFS PWD	144
ATFS CD directory	144
ATFS MD directory	144
ATFS LS [directory]	144
ATFS PUT filename	144
ATFS XPUT filename	145
ATFS HASH filename	145
ATFS GET filename	145
ATFS MV source_path dest_path	145

ATFS RM file_or_directory	145
ATFS INFO	145
ATFS FORMAT confirm	145

Operate in API mode

API mode overview	147
Use the AP command to set the operation mode	147
API frame format	147
API operation (AP parameter = 1)	147
API operation with escaped characters (AP parameter = 2)	148

API frames

AT Command - 0x08	152
Transmit (TX) SMS - 0x1F	153
Transmit (TX) Request: IPv4 - 0x20	154
Tx Request with TLS Profile - 0x23	156
AT Command Response - 0x88	158
Transmit (TX) Status - 0x89	159
Modem Status - 0x8A	161
Receive (RX) Packet: SMS - 0x9F	162
Receive (RX) Packet: IPv4 - 0xB0	163

Configure the XBee Smart Modem using Digi Remote Manager

Create a Remote Manager account	165
Get the XBee Smart Modem IMEI number	165
Add a XBee Smart Modem to Remote Manager	165
Update the firmware	166
Update the firmware using web services	166
Example: update the XBee firmware synchronously with Python 3.0	166
Example: use the device's firmware image to update the XBee firmware synchronously	167

Troubleshooting

Cannot find the serial port for the device	170
Condition	170
Solution	170
Other possible issues	171
Enable Virtual COM port (VCP) on the driver	171
Correct a macOS Java error	172
Condition	172
Solution	172
Unresponsive cellular component in Bypass mode	173
Condition	173
Solution	173
Not on expected network after APN change	174
Condition	174
Solution	174
Syntax error at line 1	174
Solution	174
Error Failed to send SMS	174

Solution174

Regulatory information

Modification statement176
Interference statement176
FCC Class B digital device notice176
RF exposure177
FCC-approved antennas177
 Bluetooth antennas177
 Dipole antennas177
 Flex PCB antennas177
 Cellular antennas178
Labeling requirements for the host device178

Digi XBee3 Cellular LTE Cat 1 Smart Modem User Guide

The XBee Smart Modem contains a u-blox R410M-02B module that also supports NB-IoT. Digi has not released support for the NB-IoT feature. Contact your sales representative if you would like more information about our roadmap to support NB-IoT.

The XBee Smart Modem is an embedded Long-Term Evolution (LTE) Category 1 cellular module that provides original equipment manufacturers (OEMs) with a simple way to integrate cellular connectivity into their devices.

The XBee Smart Modem enables OEMs to quickly integrate cutting edge 4G cellular technology into their devices and applications without dealing with the painful, time-consuming, and expensive FCC and carrier end-device certifications.

With the full suite of standard XBee API frames and AT commands, existing XBee customers can seamlessly transition to this new device with only minor software adjustments. When OEMs add the XBee Smart Modem to their product, they create a future-proof design with flexibility to switch between wireless protocols or frequencies as needed.

You can read some frequently asked questions [here](#).

Applicable firmware and hardware

This manual supports the following firmware:

- 310xx

It supports the following hardware:

- XB3-C-A1-UT-xxx

SIM cards

The XBee Smart Modem requires a 4FF (Nano) size SIM card. The SIM interface supports both 1.8 V and 3 V SIM types.

Get started with the XBee Smart Modem Development Kit

This section describes how to connect the hardware in the XBee Smart Modem Development Kit, and provides some examples you can use to communicate with the device.

1. [Identify the kit contents](#)
2. [Connect the hardware](#)
3. [Review the development board](#)
4. [Set up cellular service](#)
5. [Configure the device using XCTU](#)
6. Use one of the following methods to verify your cellular connection:
 - [Connect to the Echo server](#)
 - [Connect to the ELIZA server](#)
 - [Connect to the Daytime server](#)
7. Review additional connection examples to help you learn how to use the device. See [Connection examples](#).
8. Review introductory MicroPython examples. See [Get started with MicroPython](#).

Identify the kit contents

The Developer's kit includes the following:

One XBIB-U-DEV board

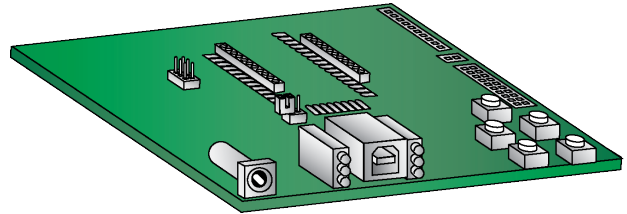

One 12 V power supply

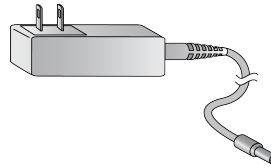

Two cellular antennas with U.FL connectors

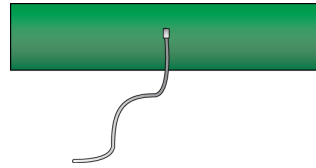

One USB cable

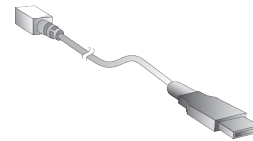

One XBee Smart Modem

Note The XBee Smart Modem comes attached to the board in ESD wrap.

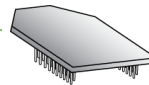

One SIM card



Connect the hardware

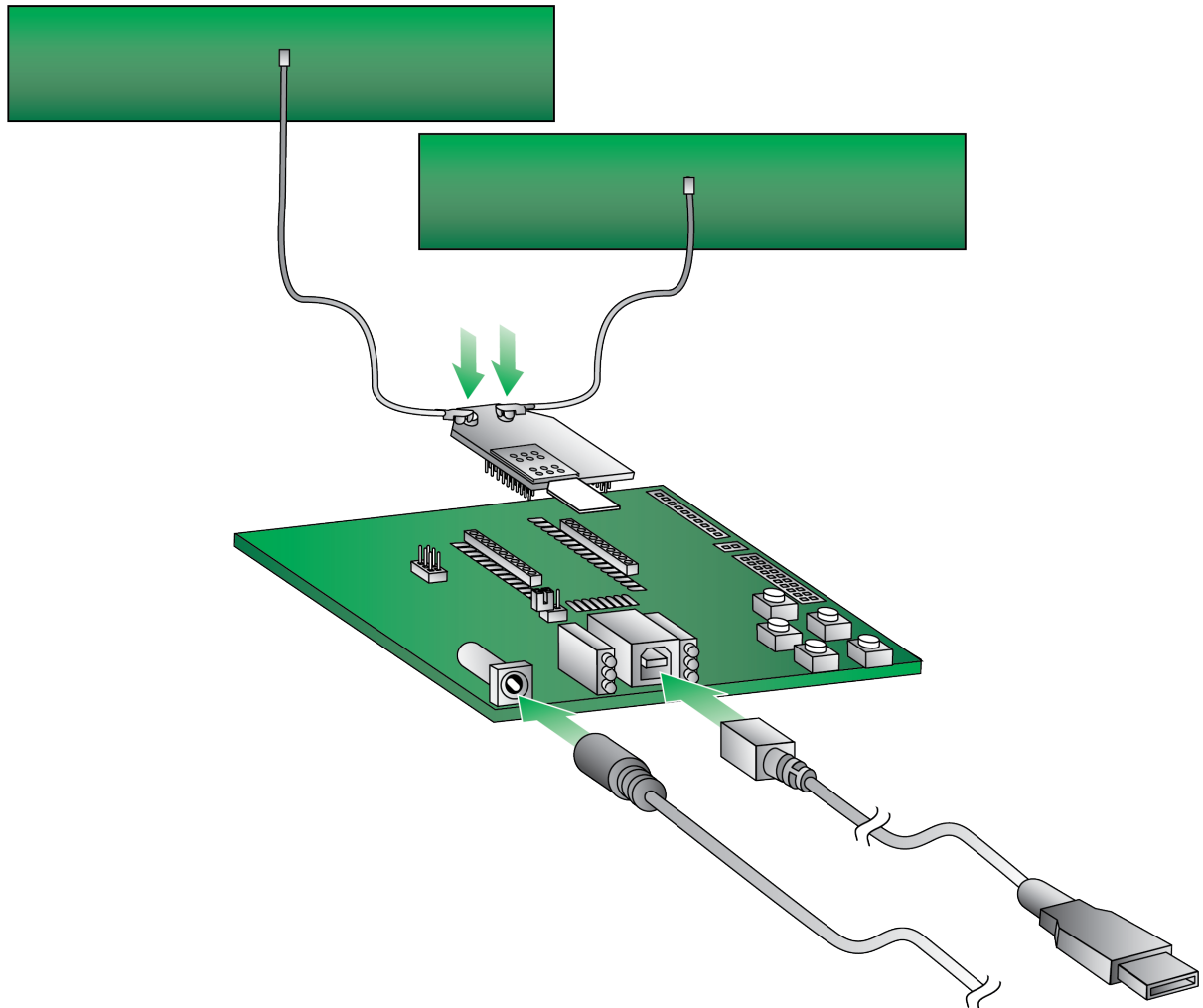

1. The XBee Smart Modem should already be plugged into the XBIB-U-DEV board.
2. The SIM card should already be inserted into the XBee Smart Modem. If not, install the SIM card into the XBee Smart Modem.

WARNING! Never insert or remove the SIM card while the device is powered!





3. Connect the antennas to the XBee Smart Modem by aligning the U.FL connectors carefully, then firmly pressing straight down to seat the connector. You should hear a snap when the antenna attaches correctly. U.FL is fragile and is not designed for multiple insertions, so exercise caution when connecting or removing the antennas. We recommend using a U.FL removal tool.

4. Plug the 12 V power supply to the power jack on the development board.
5. Connect the USB cable from a PC to the USB port on the development board. The computer searches for a driver, which can take a few minutes to install.

XBIB-U-DEV reference

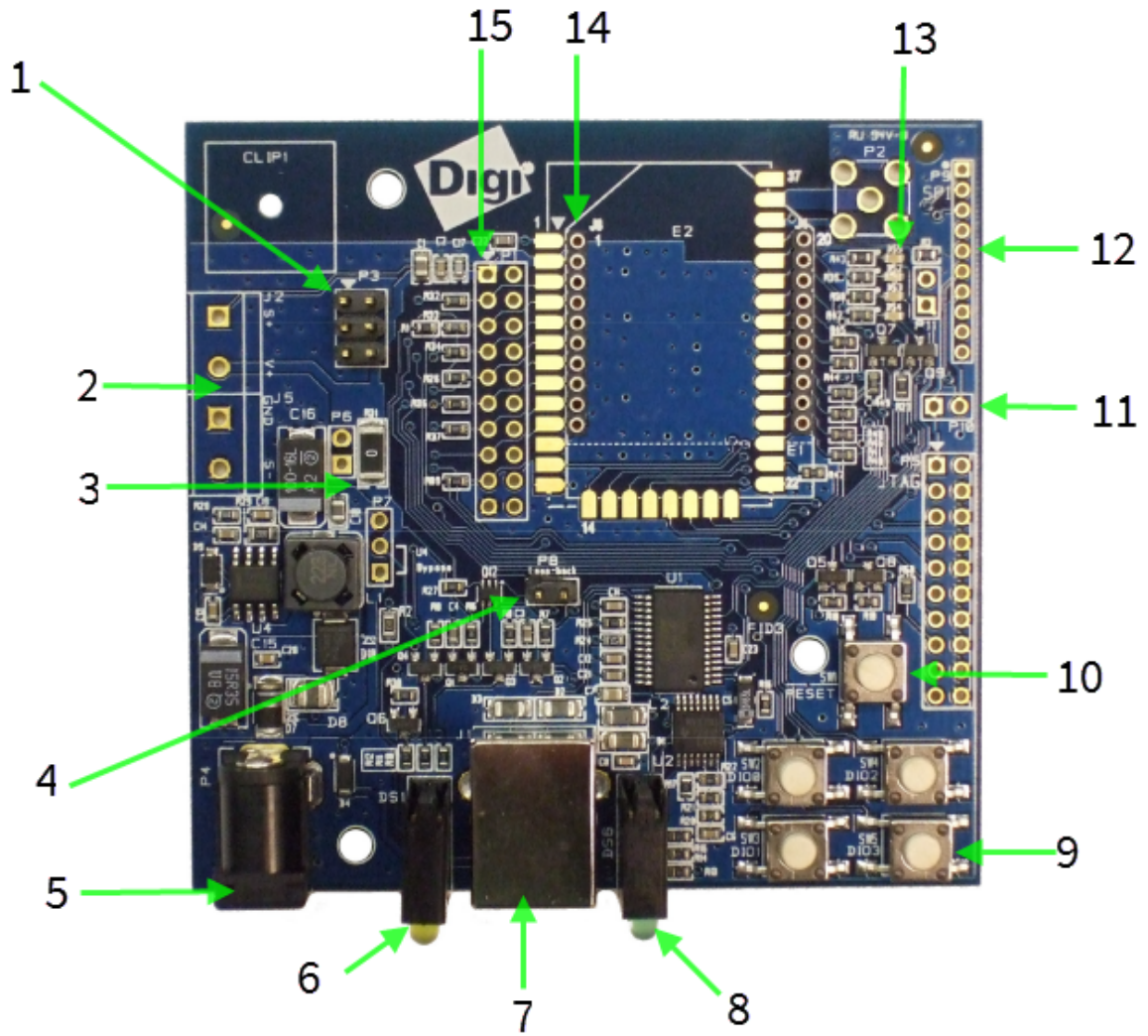
This picture shows the XBee USB development board and the table that follows explains the callouts in the picture.



Number	Item	Description
1	Programming header	Header used to program XBee programmable devices.
2	Self power module	Advanced users only—voids the warranty. Depopulate R31 to power the device using V+ and GND from J2 and J5. You can connect sense lines to S+ and S- for sensing power supplies.  CAUTION: Voltage is not regulated. Applying the incorrect voltage can cause fire and serious injury. ¹
3	Current testing	Depopulating R31 allows a current probe to be inserted across P6 terminals. The current through P6/R31 powers the device only. Other supporting circuitry is powered by a different trace.
4	Loopback jumper	Populating P8 with a loopback jumper causes serial transmissions both from the device and from the USB to loopback.
5	DC barrel plug: 6-20 V	Greater than 500 mA loads require a DC supply for correct operation. Plug in the external power supply prior to the USB connector to ensure that proper USB communications are not interrupted.
6	LED indicator	Yellow: Modem sending serial/UART data to host. Green: Modem receiving serial/UART data from host. Red: Associate.
7	USB	
8	RSSI indicator	See RSSI PWM . On the XBIB-U, more lights are better.
9	User buttons	Connected to DIO lines for user implementation.
10	Reset button	
11	SPI power	Connect to the power board from 3.3 V.
12	SPI	Only used for surface-mount devices.
13	Indicator LEDs	DS5: ON/SLEEP DS2: DIO12, the LED illuminates when driven low. DS3: DIO11, the LED illuminates when driven low. DS4: DIO4, the LED illuminates when driven low.
14	Through-hole XBee sockets	
15	20-pin header	Maps to standard through-hole XBee pins.

Cellular service

Digi now offers Cellular Bundled Service plans. This service includes preconfigured cellular data options that are ideal for IoT applications, bundled together with Digi Remote Manager for customers

¹Powering the board with J2 and J5 without R31 removed can cause shorts if the USB or barrel plug power are connected. Applying too high a voltage destroys electronic circuitry in the device and other board components and/or can cause injury.

who want to remotely monitor and manage their devices. To learn more, or obtain the plan that is right for your needs, contact us:

- By phone: 1-877-890-4014 (USA/toll free) or +1-952-912-3456 (International). Select the **Wireless Plan Support** or **Activation** option in the menu.
- By email: Data.Plan.QuoteDesk@digicom.com.

The XBee Cellular kit includes six months of free cellular service.¹

Configure the device using XCTU

XBee Configuration and Test Utility (**XCTU**) is a multi-platform program that enables users to interact with Digi radio frequency (RF) devices through a graphical interface. The application includes built-in tools that make it easy to set up, configure, and test Digi RF devices.

XCTU does not work directly over an SPI interface.

For instructions on downloading and using XCTU, see the [XCTU User Guide](#).

To use XCTU, you may need to install FTDI Virtual COM port (VCP) drivers onto your computer. Click [here](#) to download the drivers for your operating system.

Note If you are on a macOS computer and encounter problems installing XCTU, see [Correct a macOS Java error](#).

Add a device

These instructions show you how to add the XBee Smart Modem to XCTU.

If XCTU does not find your serial port, see [Cannot find the serial port for the device](#) and [Enable Virtual COM port \(VCP\) on the driver](#).

1. Launch XCTU .

Note XCTU's **Update the radio module firmware** dialog box may open and will not allow you to continue until you click **Update** or **Cancel** on the dialog.

2. Click **Help > Check for XCTU Updates** to ensure you are using the latest version of XCTU.
3. Click the **Discover radio modules** button .
4. In the **Discover radio devices** dialog, select the serial ports where you want to look for XBee modules, and click **Next**.
5. In the **Set port parameters** window, maintain the default values and click **Finish**.
6. As XCTU locates radio modules, they appear in the **Discovering radio modules** dialog box.

If your module could not be found, XCTU displays the **Could not find any radio module** dialog providing possible reasons why the module could not be added.

¹Six months of free cellular service assumes a rate of 5 Mb/month. If you exceed a limit of 30 Mb during the six month period your SIM will be deactivated.

Check for cellular registration and connection

In the following examples, proper cellular network registration and address assignment must occur successfully. The LED on the development board blinks when the XBee Smart Modem is registered to the cellular network; see [The Associate LED](#). If the LED remains solid, registration has not occurred properly.

Registration can take several minutes.

Note Make sure you are in an area with adequate cellular network reception or the XBee Smart Modem will not make the connection.

Note Check the antenna connections if the device has trouble connecting to the network.

In addition to the LED confirmation, you can check the AT commands below in XCTU to check the registration and connection. To view these commands:

1. Open XCTU and [Add a device](#).
2. Click the **Configuration working mode**  button.
3. Select a device from the **Radio Modules** list. XCTU displays the current firmware settings for that device.
4. [Update to the latest firmware](#).

Note To search for an AT command in XCTU, use [the search box](#) .

The relevant commands are:

- **AI (Association Indication)** reads zero when the device successfully registers to the cellular network. If it reads **23** it is connecting to the Internet; **22** means it is registering to the cellular network.
- **MY (Module IP Address)** should display a valid IP address. If it reads **0.0.0.0**, it has not registered yet.

Note To read a command's value, click the **Read** button  next to the command.

Update to the latest firmware

Firmware is the program code stored in the device's persistent memory that provides the control program for the device. Use XCTU to update the firmware.

Note If you have already updated the firmware in a previous step, this process is not necessary.

1. Click the **Configuration working modes** button .
2. Select a local XBee module from the **Radio Modules** list.

3. Click the **Update firmware** button  to ensure you have the most current firmware.
The **Update firmware** dialog displays the available and compatible firmware for the selected XBee module.
4. Make sure you check the **Force the module to maintain its current configuration** box and then click **Update**.
5. Select the product family of the XBee module, the function set, and the latest firmware version.
6. Click **Update**. A dialog displays update progress. Click **Show details** for details of the firmware update process.

See [How to update the firmware of your modules](#) in the *XCTU User Guide* for more information.

Connection examples

The following examples provide some additional scenarios you can try to get familiar with the XBee Smart Modem.

Connect to the Echo server	22
Connect to the ELIZA server	24
Connect to the Daytime server	26
Send an SMS message to a phone	28
Perform a (GET) HTTP request	30
Get started with CoAP	32
Connect to a TCP/IP address	37
Get started with MQTT	39
Software libraries	47



Connect to the Echo server



This server echoes back the messages you type.

The following table explains the AT commands that you use in this example.

At command	Value	Description
IP (IP Protocol)	1	Set the expected transmission mode to TCP communications.
TD (Text Delimiter)	D (0x0D)	The text delimiter to be used for Transparent mode, as an ASCII hex code. No information is sent until this character is entered, unless the maximum number of characters has been reached. Set to zero to disable text delimiter checking. Set to D for a carriage return.
DL (Destination Address)	52.43.121.77	The target IP address of the echo server.
DE (Destination Port)	0x2329	The target port number of the echo server.

To communicate with the Echo server:

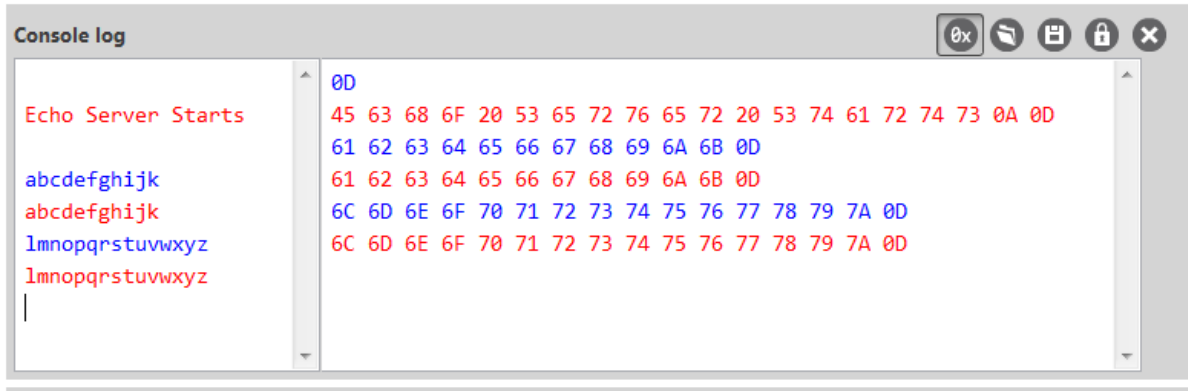

1. Ensure that the device is set up correctly with the SIM card installed and the antennas connected as described in [Connect the hardware](#).
2. Open XCTU and [Add a device](#).
3. Click the **Configuration working mode**  button.
4. Select a device from the **Radio Modules** list. XCTU displays the current firmware settings for that device.
5. To switch to TCP communication, in the **IP** field, select 1 and click the **Write** button .
6. To enable the XBee Smart Modem to recognize carriage return as a message delimiter, in the **TD** field, type **D** and click the **Write** button.
7. To enter the destination address of the echo server, in the **DL** field, type **52.43.121.77** and click the **Write** button.
8. To enter the destination IP port number, in the **DE** field, type **2329** and click the **Write** button.

9. Click the **Consoles working mode** button  on the toolbar to open a serial console to the device. For instructions on using the Console, see the [AT console](#) topic in the *XCTU User Guide*.
10. Click the **Open** button  to open a serial connection to the device.
11. Click in the left pane of the **Console log**, then type in the Console to talk to the echo server. The following screenshot provides an example of this chat.



Debugging

If you experience problems with the settings in this example, you can load the default settings in XCTU:

1. On the Configuration toolbar, click the **Default** button  to load the default values established by the firmware, and click **Yes** to confirm.
2. Factory settings are loaded but not written to the device. To write them, click the **Write** button  on the toolbar.





Connect to the ELIZA server

You can use the XBee Smart Modem to chat with the ELIZA Therapist Bot. ELIZA is an artificial intelligence (AI) bot that emulates a therapist and can perform simple conversations.

The following table explains the AT commands that you use in this example.

At command	Value	Description
IP (IP Protocol)	1	Set the expected transmission mode to TCP communications.
DL (Destination Address)	52.43.121.77	The target IP address of the ELIZA server.
DE (Destination Port)	0x2328	The target port number of the ELIZA server.

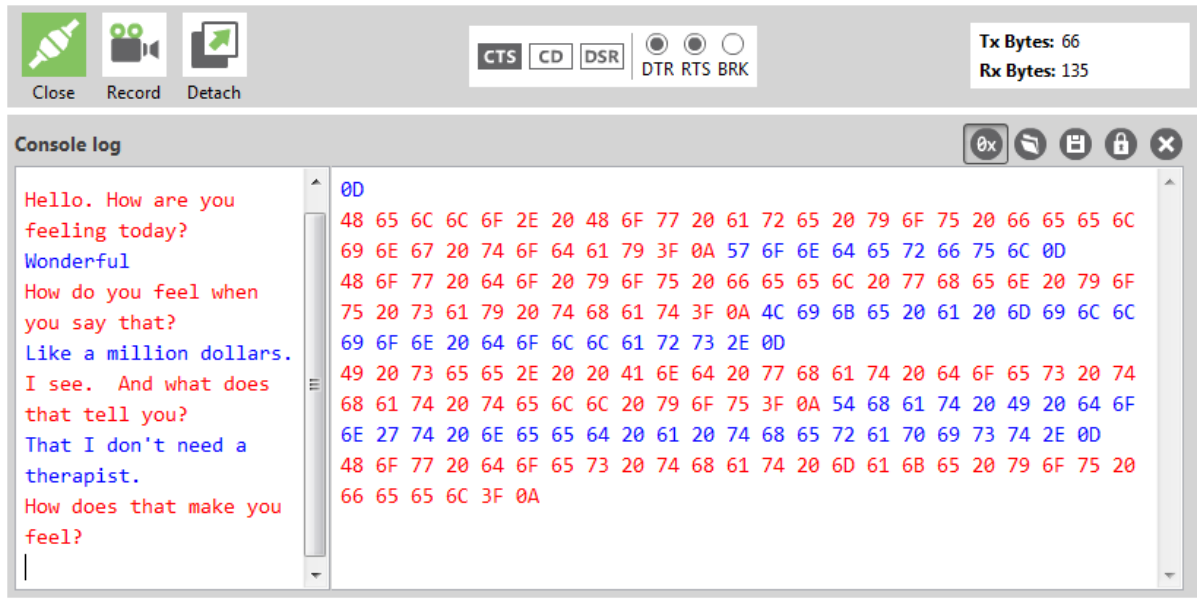

To communicate with the ELIZA Therapist Bot:

1. Ensure that the device is set up correctly with the SIM card installed and the antennas connected as described in [Connect the hardware](#).
2. Open XCTU and [Add a device](#).
3. Click the **Configuration working mode**  button.
4. Select a device from the **Radio Modules** list. XCTU displays the current firmware settings for that device.
5. To switch to TCP communication, in the **IP** field, select 1 and click the **Write** button .
6. To enter the destination address of the ELIZA Therapist Bot, in the **DL** field, type **52.43.121.77** and click the **Write** button.
7. To enter the destination IP port number, in the **DE** field, type **2328** and click the **Write** button.
8. Click the **Consoles working mode** button  on the toolbar to open a serial console to the device. For instructions on using the Console, see the [AT console](#) topic in the [XCTU User Guide](#).
9. Click the **Open** button  to open a serial connection to the device.
10. Click in the left pane of the **Console log**, then type in the Console to talk to the ELIZA Therapist Bot. The following screenshot provides an example of this chat with the user's text in blue.



Debugging

If you experience problems with the settings in this example, you can load the default settings in XCTU:

1. On the Configuration toolbar, click the **Default** button  to load the default values established by the firmware, and click **Yes** to confirm.
2. Factory settings are loaded but not written to the device. To write them, click the **Write** button  on the toolbar.





Connect to the Daytime server

The Daytime server reports the current Coordinated Universal Time (UTC) value responding to any user input.

The following table explains the AT commands that you use in this example.

At command	Value	Description
IP (IP Protocol)	1	Set the expected transmission mode to TCP communications.
DL (Destination Address)	52.43.121.77	The target IP of the Daytime server.
DE (Destination Port)	0x232A	The target port number of the Daytime server.
TD (Text Delimiter)	0	The text delimiter to be used for Transparent mode, as an ASCII hex code. No information is sent until this character is entered, unless the maximum number of characters has been reached. Set to zero to disable text delimiter checking.

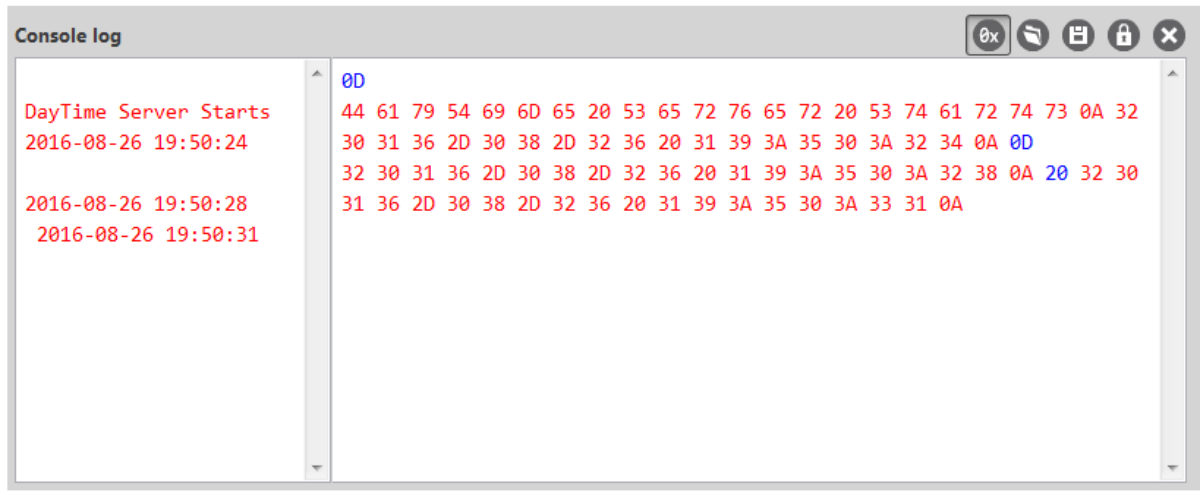

To communicate with the Daytime server:

1. Ensure that the device is set up correctly with the SIM card installed and the antennas connected as described in [Connect the hardware](#).
2. Open XCTU and [Add a device](#).
3. Click the **Configuration working mode**  button.
4. Select a device from the **Radio Modules** list. XCTU displays the current firmware settings for that device.
5. To switch to TCP communication, in the **IP** field, select 1 and click the **Write** button .
6. To enter the destination address of the daytime server, in the **DL** field, type **52.43.121.77** and click the **Write** button.
7. To enter the destination IP port number, in the **DE** field, type **232A** and click the **Write** button.
8. To disable text delimiter checking, in the **TD** field, type **0** and click the **Write** button.
9. Click the **Consoles working mode** button  on the toolbar to open a serial console to the device. For instructions on using the Console, see the [AT console](#) topic in the *XCTU User Guide*.
10. Click the **Open** button  to open a serial connection to the device.
11. Click in the left pane of the **Console log**, then type in the Console to query the Daytime server. The following screenshot provides an example of this chat.



Debugging

If you experience problems with the settings in this example, you can load the default settings in XCTU:





1. On the Configuration toolbar, click the **Default** button  to load the default values established by the firmware, and click **Yes** to confirm.
2. Factory settings are loaded but not written to the device. To write them, click the **Write** button  on the toolbar.

Send an SMS message to a phone

The XBee Smart Modem can send and receive Short Message Service (SMS) transmissions (text messages) while in Transparent mode. This allows you to send and receive text messages to and from an SMS capable device such as a mobile phone.

The following table explains the AT commands that you use in this example.

Command	Value	Description
AP (API Enable)	0	Set the device's API mode to Transparent mode.
IP (IP Protocol)	2	Set the expected transmission mode to SMS communication.
P# (Destination Phone Number)	<Target phone number>	The target phone number that you send to, for example, your cellular phone. See P# (Destination Phone Number) for instructions on using this command.
TD (Text Delimiter)	D (0x0D)	The text delimiter to be used for Transparent mode, as an ASCII hex code. No information is sent until this character is entered, unless the maximum number of characters has been reached. Set to 0 to disable text delimiter checking. Set to D for a carriage return.
PH (Module's SIM phone number)	Read only	The value that represents your device's phone number as supplied by the SIM card. This is used to send text messages to the device from another cellular device.

1. Ensure that the device is set up correctly with the SIM card installed and the antennas connected as described in [Connect the hardware](#).
2. Open XCTU and [Add a device](#).
3. Click the **Configuration working mode**  button.
4. Select a device from the **Radio Modules** list. XCTU displays the current firmware settings for that device.
5. To switch to SMS communication, in the **IP** field, select **2** and click the **Write** button .
6. To enter your cell phone number, in the **P#** field, type the **<target phone number>** and click the **Write** button. Type the phone number using only numbers, with no dashes. You can use the **+** prefix if necessary. The target phone number is the phone number you wish to send a text to.
7. In the **TD** field, type **D** and click the **Write** button.
8. Note the number in the **PH** field; it is the XBee Smart Modem phone number, which you see when it sends an SMS to your phone.
9. Click the **Consoles working mode** button  on the toolbar to open a serial console to the device. For instructions on using the Console, see the [AT console](#) topic in the [XCTU User Guide](#).
10. Click the **Open** button  to open a serial connection to the device.

- Click in the left pane of the **Console log**, type **hello world** and press **Enter**. The XBee Smart Modem sends the message to the destination phone number set by the **P#** command.

Note If you are receiving individual characters, verify that you set **TD** correctly.

- When the phone receives the text, you can see that the sender's phone number matches the value reported by the XBee Smart Modem with the **PH** command.
- On the phone, reply with the text **connect with confidence** and the XBee Smart Modem outputs this reply from the UART.



The screenshot shows a console log window with the following content:

```

Console log
hello world
Connect with confidence
68 65 6C 6C 6F 20 77 6F 72 6C 64 0D
43 6F 6E 6E 65 63 74 20 77 69 74 68 20 63 6F 6E 66 69 64 65 6E 63 65
  
```

Debugging





If you experience problems with the settings in this example, you can load the default settings in XCTU:

- On the Configuration toolbar, click the **Default** button  to load the default values established by the firmware, and click **Yes** to confirm.
- Factory settings are loaded but not written to the device. To write them, click the **Write** button  on the toolbar.

Perform a (GET) HTTP request

You can use the XBee Smart Modem to perform a GET Hypertext Transfer Protocol (HTTP) request using XCTU. HTTP is an application-layer protocol that runs over TCP. This example uses httpbin.org/ as the target website that responds to the HTTP request.

To perform a GET request:

1. Ensure that the device is set up correctly with the SIM card installed and the antennas connected as described in [Connect the hardware](#).
2. Open XCTU and [Add a device](#).
3. Click the **Configuration working mode**  button.
4. Select a device from the **Radio Modules** list. XCTU displays the current firmware settings for that device.
5. To enter the destination address of the target website, in the **DL** field, type **httpbin.org** and click the **Write** button .
6. To enter the HTTP request port number, in the **DE** field, type **50** and click the **Write** button. Hexadecimal **50** is 80 in decimal.
7. To switch to TCP communication, in the **IP** field, select **1** and click the **Write** button.
8. To move into Transparent mode, in the **AP** field, select **0** and click the **Write** button.
9. Wait for the **AI** (Association Indication) value to change to **0** (Connected to the Internet).
10. Click the **Consoles working mode** button  on the toolbar.
11. From the AT console, click the **Add new packet button**  in the Send packets dialog. The **Add new packet** dialog appears.
12. Enter the name of the data packet.
13. Type the following data in the **ASCII** input tab:
GET /ip HTTP/1.1
Host: httpbin.org
14. Click the **HEX** input tab and add **0A** (zero A) after each **0D** (zero D), and add an additional **0D 0A** at the end of the message body. For example, copy and past the following text into the **HEX** input tab:
47 45 54 20 2F 69 70 20 48 54 54 50 2F 31 2E 31 0D 0A 48 6F 73 74 3A 20 68 74 74 70 62 69 6E
2E 6F 72 67 0D 0A 0D 0A



Note The HTTP protocol requires an empty line (a line with nothing preceding the CRLF) to terminate the request.

15. Click **Add packet**.
16. Click the **Open** button .

17. Click **Send selected packet**.
18. A GET HTTP response from httpbin.org appears in the Console log.

Debugging

If you experience problems with the settings in this example, you can load the default settings in XCTU:

1. On the Configuration toolbar, click the **Default** button  to load the default values established by the firmware, and click **Yes** to confirm.
2. Factory settings are loaded but not written to the device. To write them, click the **Write** button  on the toolbar.

Get started with CoAP

Constrained Application Protocol (CoAP) is based on UDP connection and consumes low power to deliver similar functionality to HTTP. This guide contains information about sending GET, POST, PUT and DELETE operations by using the Coap Protocol with XCTU and Python code working with the XBee Smart Modem and Coapthon library (Python 2.7 only).

The Internet Engineering Task Force describes CoAP as:

The protocol is designed for machine-to-machine (M2M) applications such as smart energy and building automation. CoAP provides a request/response interaction model between application endpoints, supports built-in discovery of services and resources, and includes key concepts of the Web such as URIs and Internet media types. CoAP is designed to easily interface with HTTP for integration with the Web while meeting specialized requirements such as multicast support, very low overhead, and simplicity for constrained environments ([source](#)).

CoAP terms

When describing CoAP, we use the following terms:

Term	Meaning
Method	COAP's method action is similar to the HTTP method. This guide discusses the GET, POST, PUT and DELETE methods. With these methods, the XBee Smart Modem can transport data and requests.
URI	URI is a string of characters that identifies a resource served at the server.
Token	A token is an identifier of a message. The client uses the token to verify if the received message is the correct response to its query.
Payload	The message payload is associated with the POST and PUT methods. It specifies the data to be posted or put to the URI resource.
Message ID	The message ID is also an identifier of a message. The client matches the message ID between the response and query.

CoAP quick start example

The following diagram shows the message format for the CoAP protocol; see [ISSN: 2070-1721](#) for details:

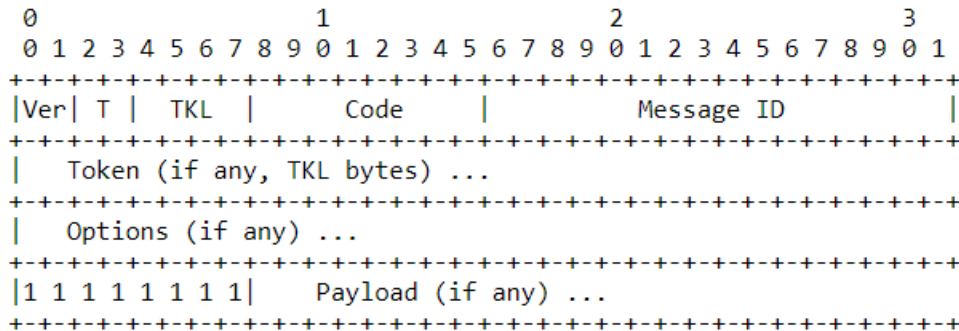





This is an example GET request:

```
44 01 C4 09 74 65 73 74 B7 65 78 61 6D 70 6C 65
```

The following table describes the fields in the GET request.



Field	HEX	Bits	Meaning
Ver	44	01	Version 01, which is mandatory here.
T		00	Type 0: confirmable.
TKL		0100	Token length: 4.
Code	01	000 00001	Code: 0.01, which indicates the GET method.
Message ID	C4 09	2 Bytes equal to hex at left	Message ID. The response message will have the same ID. This can help out identification.
Token	74 65 73 74	4 Bytes equal to hex at left	Token. The response message will have the same token. This can help out identification.
Option delta	B7	1011	Delta option: 11 indicates the option data is Uri-Path.
Option length		0111	Delta length: 7 indicates there are 7 bytes of data following as a part of this delta option.
Option value	65 78 61 6D 70 6C 65	7 Bytes equal to hex at left	Example.

Configure the device

1. Ensure that the device is set up correctly with the SIM card installed and the antennas connected as described in [Connect the hardware](#).
2. Open XCTU and click the **Configuration working mode**  button.
3. Add the XBee Smart Modem to XCTU; see [Add a device](#).
4. Select a device from the **Radio Modules** list. XCTU displays the current firmware settings for that device.
5. To switch to UDP communication, in the **IP** field, select **0** and click the **Write** button .
6. To set the target IP address that the XBee Smart Modem will talk to, in the **DL** field type **52.43.121.77** and click the **Write** button . A CoAP server is publicly available at address 52.43.121.77.
7. To set the XBee Smart Modem to send data to port 5683 in decimal, in the **DE** field, type **1633** and click the **Write** button.
8. To move into Transparent mode, in the **AP** field, select **0** and click the **Write** button.
9. Wait for the **AI** (Association Indication) value to change to **0** (Connected to the Internet). You can click **Read**  to get an update on the **AI** value.

Example: manually perform a CoAP request

Follow the steps in [Configure the device](#) prior to this example. This example performs the CoAP GET request:

- Method: GET
 - URI: example
 - Given message token: test
1. Click the **Consoles working mode** button  on the toolbar to add a customized packet.
 2. From the AT console, click the **Add new packet button**  in the Send packets dialog. The **Add new packet** dialog appears.
 3. Click the **HEX** tab and type the name of the data packet: **GET_EXAMPLE**.
 4. Copy and paste the following text into the **HEX** input tab:
44 01 C4 09 74 65 73 74 B7 65 78 61 6D 70 6C 65
This is the CoAP protocol message decomposed by bytes to perform a GET request on an example URI with a token test.
 5. Click **Add packet**.
 6. Click the **Open** button .
 7. Click **Send selected packet**. The message is sent to the public CoAP server configured in [Configure the device](#). A response appears in the Console log. Blue text is the query, red text is the response.

The payload is **Get to uri: example**, which specifies that this is a successful CoAP GET to URI end example, which was specified in the query.

Click the **Close** button to terminate the serial connection.

Example: use Python to generate a CoAP message

This example illustrates how the CoAP protocol can perform GET/POST/PUT/DELETE requests similarly to the HTTP protocol and how to do this using the XBee Smart Modem. In this example, the XBee Smart Modem talks to a CoAP Digi Server. You can use this client code to provide an abstract wrapper to generate a CoAP message that commands the XBee Smart Modem to talk to the remote CoAP server.

Note It is crucial to configure the XBee Smart Modem settings. See [Configure the device](#) and follow the steps. You can target the IP address to a different CoAP public server.

1. Install Python 2.7. The Installation guide is located at: python.org/downloads/.
2. Download and install the CoAPthon library in the python environment from pypi.python.org/pypi/CoAPthon.
3. Download these two .txt files: [Coap.txt](#) and [CoapParser.txt](#). After you download them, open the files in a text editor and save them as .py files.
4. In the folder that you place the Coap.py and CoapParser.py files, press **Shift + right-click** and then click **Open command window**.
5. At the command prompt, type **python Coap.py** and press **Enter** to run the program.

6. Type the USB port number that the XBee Smart Modem is connected to and press **Enter**. Only the port number is required, so if the port is COM19, type 19.

Note If you do not know the port number, open XCTU and look at the XBee Smart Modem in the **Radio Modules** list. This view provides the port number and baud rate, as in the figure below where the baud rate is 9600 b/s.

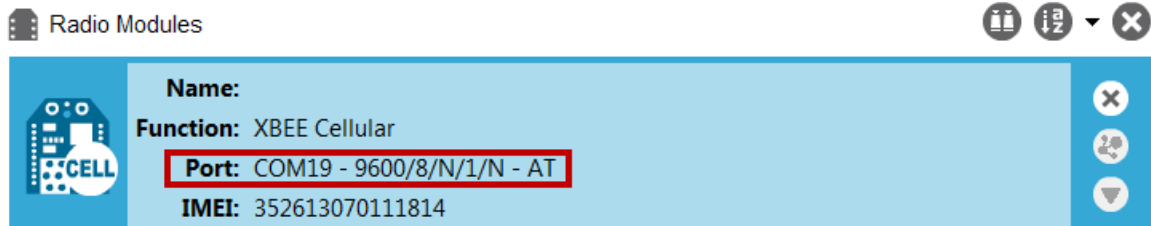

7. Type the baud rate and press **Enter**. You must match the device's current baud rate. XCTU provides the current baud rate in the **BD Baud Rate** field. In this example you would type **9600**.
8. Press **Y** if you want an auto-generated example. Press **Enter** to build your own CoAP request.
9. If you press **Y** it generates a message with:
 - Method: POST
 - URI: example
 - payload: hello world
 - token: test

The send and receive message must match the same token and message id. Otherwise, the client re-attempts the connection by sending out the request.

In the following figure, the payload contains the server response to the query. It shows the results for when you press **Enter** rather than **Y**.

```

C:\Users\jzhang\Desktop\example>python Coap.py
Please enter the serial port number for Xbee: 18
Please enter the baudrate number of Xbee: (9600 or 115200): 9600
Do you want an auto-generated example <Press Y> or build your own <Press ENTER>:

Please enter the HTTP method (GET, POST, PUT, DELETE): PUT
Please enter the uri end path: example
Please enter the payload content. And it cannot be empty: hello world
Please enter the token: digi

#####

This is the send out message:
Source: (None, None)
Destination: None
Type: CON
MID: 56045
Code: PUT
Token: digi
Uri-Path: example
Payload:
hello world

This is the received message
Source: (None, None)
Destination: None
Type: ACK
MID: 56045
Code: CHANGED
Token: digi
Payload:
Put hello world to uri: example
    
```

Connect to a TCP/IP address



The XBee Smart Modem can send and receive TCP messages while in Transparent mode; see [Transparent operating mode](#).

Note You can use this example as a template for sending and receiving data to or from any TCP/IP server.

The following table explains the AT commands that you use in this example.

Command	Value	Description
IP (IP Protocol)	1	Set the expected transmission mode to TCP communication.
DL (Destination IP Address)	<Target IP address>	The target IP address that you send and receive from. For example, a data logging server's IP address that you want to send measurements to.
DE (Destination Port)	<Target port number>	The target port number that the device sends the transmission to. This is represented as a hexadecimal value.



To connect to a TCP/IP address:

1. Ensure that the device is set up correctly with the SIM card installed and the antennas connected as described in [Connect the hardware](#).
2. Open XCTU and [Add a device](#).
3. Click the **Configuration working mode**  button.
4. Select a device from the **Radio Modules** list. XCTU displays the current firmware settings for that device.
5. In the **IP** field, select 1 and click the **Write** button .
6. In the **DL** field, type the <target IP address> and click the **Write** button. The target IP address is the IP address that you send and receive from.
7. In the **DE** field, type the <target port number>, converted to hexadecimal, and click the **Write** button.
8. [Exit Command mode](#).

After exiting Command mode, any UART data sent to the device is sent to the destination IP address and port number after the [RO \(Packetization Timeout\)](#) occurs.

Debugging

If you experience problems with the settings in this example, you can load the default settings in XCTU:

1. On the Configuration toolbar, click the **Default** button  to load the default values established by the firmware, and click **Yes** to confirm.
2. Factory settings are loaded but not written to the device. To write them, click the **Write** button  on the toolbar.

Get started with MQTT

MQ Telemetry Transport (MQTT) is a messaging protocol that is ideal for the Internet of Things (IoT) due to a light footprint and its use of the publish-subscribe model. In this model, a client connects to a broker, a server machine responsible for receiving all messages, filtering them, and then sending messages to the appropriate clients.

The first two MQTT examples do not involve the XBee Smart Modem. They demonstrate using the MQTT libraries because those libraries are required for [Use MQTT over the XBee Cellular Modem with a PC](#).

The examples in this guide assume:

- Some knowledge of Python.
- An integrated development environment (IDE) such as PyCharm, IDLE or something similar.

The examples require:

- An XBee Smart Modem.
- A compatible development board, such as the XBIB-U.
- XCTU. See [Configure the device using XCTU](#).
- That you install Python on your computer. You can download Python from: <https://www.python.org/downloads/>.
- That you install the **pyserial** and **paho-mqtt** libraries to the Python environment. If you use Python 2, install these libraries from the command line with **pip install pyserial** and **pip install paho-mqtt**. If you use Python 3, use **pip3 install pyserial** and **pip3 install paho-mqtt**.
- The full MQTT library source code, which includes examples and tests, which is available in the paho-mqtt github repository at <https://github.com/eclipse/paho.mqtt.python>. To download this repository you must have Git installed.

Example: MQTT connect

This example provides insight into the structure of packets in MQTT as well as the interaction between the client and broker. MQTT uses different packets to accomplish tasks such as connecting, subscribing, and publishing. You can use XCTU to perform a basic example of sending a broker a connect packet and receiving the response from the server, without requiring any coding. This is a good way to see how the client interacts with the broker and what a packet looks like. The following table is an example connect packet:

	Description	Hex value
CONNECT packet fixed header		
byte 1	Control packet type	0x10
byte 2	Remaining length	0x10
CONNECT packet variable header		
Protocol name		

	Description	Hex value
byte 1	Length MSB (0)	0x00
byte 2	Length LSB (4)	0x04
byte 3	(M)	0x4D
byte 4	(Q)	0x51
byte 5	(T)	0x54
byte 6	(T)	0x54
Protocol level		
byte 7	Level (4)	0x04
Connect flags		
byte 8	CONNECT flags byte, see the table below for the bits.	0X02
Keep alive		
byte 9	Keep Alive MSB (0)	0X00
byte 10	Keep Alive LSB (60)	0X3C
Client ID		
byte 11	Length MSB (0)	0x00
byte 12	Length LSB (4)	0x04
byte 13	(D)	0x44
byte 14	(l)	0x49
byte 15	(G)	0x47
byte 16	(l)	0x49

The following table describes the fields in the packet:

Field name	Description
Protocol Name	The connect packet starts with the protocol name, which is MQTT. The length of the protocol name (in bytes) is immediately before the name itself.
Protocol Level	Refers to the version of MQTT in use, in this case a value of 4 indicates MQTT version 3.1.1.
Connect Flags	Indicate certain aspects of the packet. For simplicity, this example only sets the Clean Session flag, which indicates to the client and broker to discard any previous session and start a new one.
Keep Alive	How often the client pings the broker to keep the connection alive; in this example it is set to 60 seconds.



Field name	Description
Client ID	The length of the ID (in bytes) precedes the ID itself. Each client connecting to a broker must have a unique client ID. In the example, the ID is DIGI. When using the Paho MQTT Python libraries, a random alphanumeric ID is generated if you do not specify an ID.

The following table provides the CONNECT flag bits from byte 8, the CONNECT flags byte.

CONNECT Flag Bit(s)	Bit 7	Bit 6	Bit 5	Bit 4	Bit 3	Bit 2	Bit 1	Bit 0
User name flag	0							
Password flag		0						
Will retain			0					
Will QoS				0	0			
Will flag						0		
Clean session							1	
Reserved								0

Send a connect packet

Now that you know what a connect packet looks like, you can send a connect packet to a broker and view the response. Open XCTU and click the Configuration working mode button.

1. Ensure that the device is set up correctly with the SIM card installed and the antennas connected as described in [Connect the hardware](#).
2. Open XCTU and click the **Configuration working mode**  button.
3. Add the XBee Smart Modem to XCTU; see [Add a device](#).
4. Select a device from the **Radio Modules** list. XCTU displays the current firmware settings for that device.
5. In the **AP** field, set **Transparent Mode** to **[0]** if it is not already and click the **Write** button.
6. In the **DL** field, type the IP address of the broker you wish to use. This example uses **198.41.30.241**, which is the IP address for m2m.eclipse.org, a public MQTT broker.
7. In the **DE** field, type **75B** and set the port that the broker uses. This example uses **75B**, because the default MQTT port is 1883 (0x75B).
8. Once you have entered the required values, click the **Write** button to write the changes to the XBee Smart Modem.
9. Click the **Consoles working mode**  button on the toolbar to open a serial console to the device. For instructions on using the Console, see the [AT console](#) topic in the [XCTU User Guide](#).
10. Click the **Open**  button to open a serial connection to the device.

11. From the AT console, click the **Add new packet button**  in the **Send packets** dialog. The **Add new packet** dialog appears.
12. Enter the name of the data packet. Name the packet **connect_frame** or something similar.
13. Click the **HEX** input tab and type the following (these values are the same values from the table in [Example: MQTT connect](#)):

10 10 00 04 4D 51 54 54 04 02 00 3C 00 04 44 49 47 49

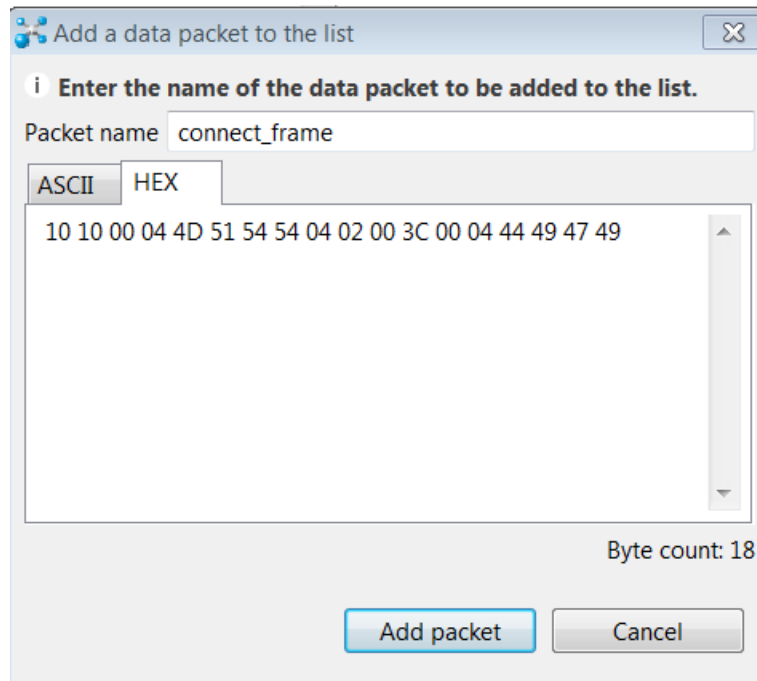

14. Click **Add packet**. The new packet appears in the **Send packets** list.
15. Click the packet in the **Send packets** list.
16. Click **Send selected packet**.
17. A CONNACK packet response from the broker appears in the **Console log**. This is a connection acknowledgment; a successful response should look like this:

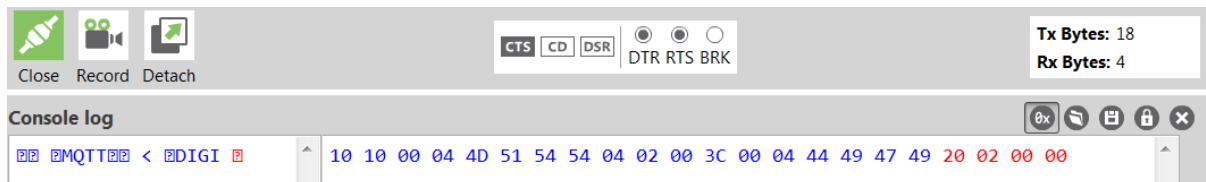

You can verify the response from the broker as a CONNACK by comparing it to the structure of a CONNACK packet in the MQTT documentation, which is available at http://docs.oasis-open.org/mqtt/mqtt/v3.1.1/os/mqtt-v3.1.1-os.html#_Toc398718081.

Example: send messages (publish) with MQTT

A basic Python example of a node publishing (sending) a message is:

```

mqttc = mqtt.Client("digitest") # Create instance of client with client ID
"digitest"
mqttc.connect("m2m.eclipse.org", 1883) # Connect to (broker, port,
keepalive-time)
mqttc.loop_start() # Start networking daemon
mqttc.publish("digitest/test1", "Hello, World!") # Publish message to
"digitest /test1" topic
mqttc.loop_stop() # Kill networking daemon

```

Note You can easily copy and paste code from the [online version of this guide](#). Use caution with the PDF version, as it may not maintain essential indentations.

This example imports the MQTT library, allowing you to use the MQTT protocol via APIs in the library, such as the **connect()**, **subscribe()**, and **publish()** methods.

The second line creates an instance of the client, named **mqttc**. The client ID is the argument you passed in: **digitest** (this is optional).

In line 3, the client connects to a public broker, in this case **m2m.eclipse.org**, on port **1883** (the default MQTT port, or 8883 for MQTT over SSL). There are many publicly available brokers available, you can find a list of them here: <https://github.com/mqtt/mqtt.github.io/wiki/brokers>.

Line 4 starts the networking daemon with **client.loop_start()** to handle the background network/data tasks.

Finally, the client publishes its message **Hello, World!** to the broker under the topic **digitest/backlog/test1**. Any nodes (devices, phones, computers, even microcontrollers) subscribed to that same topic on the same broker receive the message.

Once no more messages need to be published, the last line stops the network daemon with **client.loop_stop()**.

Example: receive messages (subscribe) with MQTT

This example describes how a client would receive messages from within a specific topic on the broker:

```

import paho.mqtt.client as mqtt

def on_connect(client, userdata, flags, rc): # The callback for when the
client connects to the broker
    print("Connected with result code {}".format(str(rc))) # Print result
of connection attempt
    client.subscribe("digitest/test1") # Subscribe to the topic
"digitest/test1", receive any messages published on it

def on_message(client, userdata, msg): # The callback for when a PUBLISH
message is received from the server.
    print("Message received-> " + msg.topic + " " + str(msg.payload)) #
Print a received msg

client = mqtt.Client("digi_mqtt_test") # Create instance of client with
client ID "digi_mqtt_test"
client.on_connect = on_connect # Define callback function for successful
connection
client.on_message = on_message # Define callback function for receipt of a

```

```

message
# client.connect("m2m.eclipse.org", 1883, 60) # Connect to (broker, port,
keepalive-time)
client.connect('127.0.0.1', 17300)
client.loop_forever() # Start networking daemon

```

Note You can easily copy and paste code from the [online version of this guide](#). Use caution with the PDF version, as it may not maintain essential indentations.

The first line imports the library functions for MQTT.

The functions **on_connect** and **on_message** are callback functions which are automatically called by the client upon connection to the broker and upon receiving a message, respectively.

The **on_connect** function prints the result of the connection attempt, and performs the subscription. It is wise to do this in the callback function as it guarantees the attempt to subscribe happens only after the client is connected to the broker.

The **on_message** function prints the received message when it comes in, as well as the topic it was published under.

In the body of the code, we:

- Instantiate a client object with the client ID **digi_mqtt_test**.
- Define the callback functions to use upon connection and upon message receipt.
- Connect to an MQTT broker at **m2m.eclipse.org**, on port **1883** (the default MQTT port, or 8883 for MQTT over SSL) with a keepalive of 60 seconds (this is how often the client pings the broker to keep the connection alive).

The last line starts a network daemon that runs in the background and handles data transactions and messages, as well as keeping the socket open, until the script ends.

Use MQTT over the XBee Cellular Modem with a PC

To use this MQTT library over an XBee Smart Modem, you need a basic proxy that transfers a payload received via the MQTT client's socket to the serial or COM port that the XBee Smart Modem is active on, as well as the reverse; transfer of a payload received on the XBee Smart Modem's serial or COM port to the socket of the MQTT client. This is simplest with the XBee Smart Modem in Transparent mode, as it does not require code to parse or create API frames, and not using API frames means there is no need for them to be queued for processing.

1. To put the XBee Cellular Modem in Transparent mode, set **AP** to **0**.
2. Set **DL** to the IP address of the broker you want to use.
3. Set **DE** to the port to use, the default is 1883 (0x75B). This sets the XBee Smart Modem to communicate directly with the broker, and can be performed in XCTU as described in [Example: MQTT connect](#).
4. You can make the proxy with a dual-threaded Python script, a simple version follows:

```

import threading
import serial
import socket

def setup():

```

```

"""
This function sets up the variables needed, including the serial port,
and it's speed/port settings, listening socket, and localhost address.
"""
global clisock, cliaddr, svrsock, ser
# Change this to the COM port your XBee Cellular module is using. On
# Linux, this will be /dev/ttyUSB#
comport = 'COM44'
# This is the default serial communication speed of the XBee Cellular
# module
comspeed = 115200
buffer_size = 4096 # Default receive size in bytes
debug_on = 0 # Enables printing of debug messages
toval = None # Timeout value for serial port below
# Serial port object for XBCell modem
ser = serial.Serial(comport,comspeed,timeout=toval)
# Listening socket (accepts incoming connection)
svrsock = socket.socket(socket.AF_INET,socket.SOCK_STREAM)
# Allow address reuse on socket (eliminates some restart errors)
svrsock.setsockopt(socket.SOL_SOCKET, socket.SO_REUSEADDR, 1)
clisock = None
cliaddr = None # These are first defined before thread creation
addrtuple = ('127.0.0.1', 17300) # Address tuple for localhost
# Binds server socket to localhost (allows client program connection)
svrsock.bind(addrtuple)
svrsock.listen(1) # Allow (1) connection

def ComReaderThread():
    """
    This thread listens on the defined serial port object ('ser') for data
    from the modem, and upon receipt, sends it out to the client over the
    client socket ('clisock').
    """
    global clisock
    while (1):
        resp = ser.read() ## Read any available data from serial port
        print("Received {} bytes from modem.".format(len(resp)))

        clisock.sendall(resp) # Send RXd data out on client socket
        print("Sent {} byte payload out socket to client.".format(len
(resp)))

def SockReaderThread():
    """
    This thread listens to the MQTT client's socket and upon receiving a
    payload, it sends this data out on the defined serial port ('ser') to
    the
    modem for transmission.
    """

    global clisock
    while (1):
        data = clisock.recv(4096) # RX data from client socket
        # If the RECV call returns 0 bytes, the socket has closed
        if (len(data) == 0):
            print("ERROR - socket has closed. Exiting socket reader
thread.")

```

```

        return 1 # Exit the thread to avoid a loop of 0-byte receptions
    else:
        print("Received {} bytes from client via socket.".format(len
(data)))
        print("Sending payload to modem...")
        bytes_wr = ser.write(data) # Write payload to modem via
UART/serial
        print("Wrote {} bytes to modem".format(bytes_wr))

def main():
    setup() # Setup the serial port and socket
    global clisock, svrsock
    if (not clisock): # Accept a connection on 'svrsock' to open 'clisock'
        print("Awaiting ACCEPT on server sock...")
        (clisock,cliaddr) = svrsock.accept() # Accept an incoming
connection
        print("Connection accepted on socket")
        # Make thread for ComReader
        comthread = threading.Thread(target=ComReaderThread)
        comthread.start() # Start the thread
        # Make thread for SockReader
        sockthread = threading.Thread(target=SockReaderThread)
        sockthread.start() # Start the thread

main()

```

Note This script is a general TCP-UART proxy, and can be used for other applications or scripts that use the TCP protocol. Its functionality is not limited to MQTT.

Note You can easily copy and paste code from the [online version of this guide](#). Use caution with the PDF version, as it may not maintain essential indentations.

This proxy script waits for an incoming connection on localhost (**127.0.0.1**), on port **17300**. After accepting a connection, and creating a socket for that connection (**clisock**), it creates two threads, one that reads the serial or COM port that the XBee Smart Modem is connected to, and one that reads the socket (**clisock**), that the MQTT client is connected to.

With:

- The proxy script running
- The MQTT client connected to the proxy script via localhost (**127.0.0.1**)
- The XBee Smart Modem connected to the machine via USB and properly powered
- **AP**, **DL**, and **DE** set correctly

the proxy acts as an intermediary between the MQTT client and the XBee Smart Modem, allowing the MQTT client to use the data connection provided by the device.

Think of the proxy script as a translator between the MQTT client and the XBee Smart Modem. The following figure shows the basic operation.

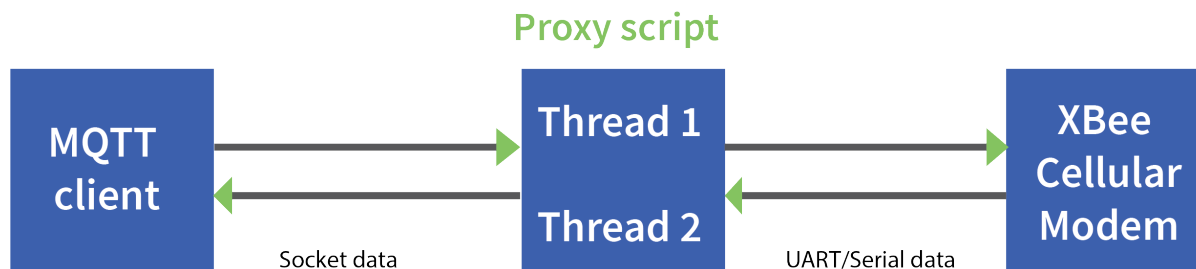

The thread that reads the serial port forwards any data received onward to the client socket, and the thread reading the client socket forwards any data received onward to the serial port. This is represented in the figure above.

The proxy script needs to be running before running an MQTT publish or subscribe script.

1. With the proxy script running, run the subscribe example from [Example: receive messages \(subscribe\) with MQTT](#), but change the connect line from `client.connect("m2m.eclipse.org", 1883, 60)` to `client.connect("127.0.0.1", port=17300, keepalive=20)`. This connects the MQTT client to the proxy script, which in turn connects to a broker via the XBee Smart Modem's internet connection.
2. Run the publish example from [Example: send messages \(publish\) with MQTT](#) in a third Python instance (while the publish script is running you will have three Python scripts running at the same time).

The publish script runs over your computer's normal Internet connection, and does not use the XBee Smart Modem. You are able to see your published message appear in the subscribe script's output once it is received from the broker via the XBee Smart Modem. If you watch the output of the proxy script during this process you can see the receptions and transmissions taking place.

The proxy script must be running before you run the subscribe and publish scripts. If you stop the subscribe script, the socket closes, and the proxy script shows an error. If you try to start the proxy script after starting the subscribe script, you may also see a socket error. To avoid these errors, it is best to start the scripts in the correct order: proxy, then subscribe, then publish.

Software libraries

One way to communicate with the XBee device is by using a software library. The libraries available for use with the XBee Smart Modem include:

- [XBee Java library](#)
- [XBee Python library](#)

The XBee Java Library is a Java API. The package includes the XBee library, its source code and a collection of samples that help you develop Java applications to communicate with your XBee devices.

The XBee Python Library is a Python API that dramatically reduces the time to market of XBee projects developed in Python and facilitates the development of these types of applications, making it an easy process.

Get started with MicroPython

This guide provides an overview of how to use MicroPython with the XBee Smart Modem. For in-depth information and more complex code examples, refer to the [Digi MicroPython Programming Guide](#). Continue with this guide for simple examples to get started using MicroPython on the XBee Smart Modem.

About MicroPython

MicroPython is an open-source programming language based on Python 3, with much of the same syntax and functionality, but modified to fit on small devices with limited hardware resources, such as microcontrollers, or in this case, a cellular modem.

Why use MicroPython

MicroPython enables on-board intelligence for simple sensor or actuator applications using digital and analog I/O. MicroPython can help manage battery life. Cryptic readings can be transformed into useful data, excess transmissions can be intelligently filtered out, modern sensors and actuators can be employed directly, and logic can glue inputs and outputs together in an intelligent way.

For more information about MicroPython, see www.micropython.org.

For more information about Python, see www.python.org.

MicroPython on the XBee Smart Modem

The XBee Smart Modem has MicroPython running on the device itself. You can access a MicroPython prompt from the XBee Smart Modem when you install it in an appropriate development board (XBDB or XBIB), and connect it to a computer via a USB cable.

Note MicroPython does not work with SPI.

The examples in this guide assume:



- You have [XCTU](#) on your computer. See [Configure the device using XCTU](#).
- You have a terminal program installed on your computer. We recommend using the [Use the MicroPython Terminal in XCTU](#). This requires XCTU 6.3.7 or higher.
- You have an XBee Smart Modem installed in an appropriate development board such as an XBIB-U-DEV or an XBIB-2.

Note Most examples in this guide require the XBIB-U-DEV board.

- The XBee Smart Modem is connected to the computer via a USB cable and XCTU recognizes it.
- The board is powered by an appropriate power supply, 12 VDC and at least 1.1 A.



Use XCTU to enter the MicroPython environment

To use the XBee Smart Modem in the MicroPython environment:

1. Use XCTU to add the device(s); see [Configure the device using XCTU](#) and [Add a device](#).
2. The XBee Smart Modem appears as a box in the **Radio Modules** information panel. Each module displays identifying information about itself.
3. Click this box to select the device and load its current settings.
4. To set the device's baud rate to 115200 b/s, in the **BD** field select **115200 [7]** or higher and click the **Write** button . We recommend using flow control to avoid data loss, especially when pasting large amounts of code/text.
5. To put the XBee Smart Modem into MicroPython mode, in the **AP** field select **MicroPython REPL [4]** and click the **Write** button .
6. Note what COM port(s) the XBee Smart Modem is using, because you will need this information when you use terminal communication. The **Radio Modules** information panel lists the COM port in use.

Use the MicroPython Terminal in XCTU

You can use the MicroPython Terminal to communicate with the XBee Smart Modem when it is in MicroPython mode.¹ This requires XCTU 6.3.7 or higher. To enter MicroPython mode, follow the steps in [Use XCTU to enter the MicroPython environment](#). To use the MicroPython Terminal:

1. Click the **Tools** drop-down menu  and select **MicroPython Terminal**. The terminal opens.
2. Click **Open**. If you have not already added devices to XCTU:
 - a. In the **Select the Serial/USB port** area, click the COM port that the device uses.
 - b. Verify that the baud rate and other settings are correct.
3. Click **OK**. The **Open** icon changes to **Close** , indicating that the device is properly connected.
4. Press **Ctrl+B** to get the MicroPython version banner and prompt.

You can now type or paste MicroPython commands at the **>>>** prompt.

Troubleshooting

If you receive **No such port: 'Port is already in use by other applications.'** in the **MicroPython Terminal** close any other console sessions open inside XCTU and close any other serial terminal programs connected to the device, then retry the MicroPython connection in XCTU.

If the device seems unresponsive, try pressing **Ctrl+C** to end any running programs.

¹See [Other terminal programs](#) if you do not use the MicroPython Terminal in XCTU.

You can use the `+++` escape sequence and look for an **OK** for confirmation that you have the correct baud rate.

Example: hello world

1. At the MicroPython `>>>` prompt, type the Python command: `print("Hello, World!")`
2. Press **Enter** to execute the command. The terminal echos back **Hello, World!**.

Example: turn on an LED

1. Note the **DS4** LED on the XBIB board. The following image highlights it in a red box. The LED is normally off.

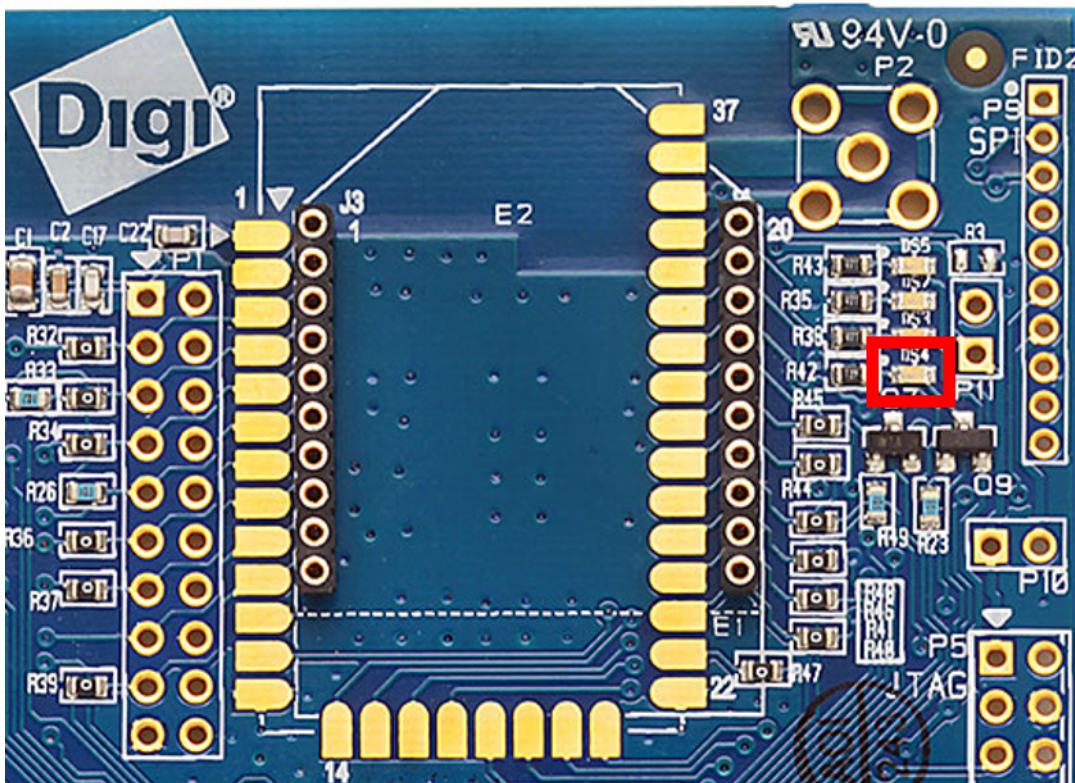

2. At the MicroPython `>>>` prompt, type the commands below, pressing **Enter** after each one. After entering the last line of code, the LED illuminates. Anything after a `#` symbol is a comment, and you do not need to type it.

Note You can easily copy and paste code from the [online version of this guide](#). Use caution with the PDF version, as it may not maintain essential indentations.

```
import machine
from machine import Pin
led = Pin("D4", Pin.OUT, value=0) # Makes a pin object set to output 0.
# One might expect 0 to mean OFF and 1 to mean ON, and this is normally the
# case.
```

```
# But the LED we are turning on and off is setup as what is# known as
"active low".
# This means setting the pin to 0 allows current to flow through the LED and
then through the pin, to ground.
```

3. To turn it off, type the following and press **Enter**:

```
led.value(1)
```

You have successfully controlled an LED on the board using basic I/O.

Example: code a request help button

This example provides a fast, deep dive into MicroPython designed to let you see some of the powerful things it can do with minimal code. It is not meant as a tutorial; for in-depth examples refer to the [Digi MicroPython Programming Guide](#).

Many stores have help buttons in their aisles that a customer can press to alert the store staff that assistance is required in that aisle. You can implement this type of system using the Digi XBee Smart Modem, and this example provides the building blocks for such a system. This example, based on SMS paging, can have many other uses such as alerting someone with a text to their phone if a water sensor in a building detects water on the floor, or if a temperature sensor reports a value that is too hot or cold relative to normal operation.

Enter MicroPython paste mode

In the following examples it is helpful to know that MicroPython supports [paste mode](#), where you can copy a large block of code from this user guide and paste it instead of typing it character by character. To use paste mode:

1. Copy the code you want to run. For example, copy the following code that is the code from the LED example:

```
from machine import Pin
led = Pin("D4", Pin.OUT, value=0)
```

Note You can easily copy and paste code from the [online version of this guide](#). Use caution with the PDF version, as it may not maintain essential indentations.

2. In the terminal, at the MicroPython `>>>` prompt type **Ctrl+E** to enter paste mode. The terminal displays **paste mode; Ctrl-C to cancel, Ctrl-D to finish**.
3. The code appears in the terminal occupying four lines, each line starts with its line number and three = symbols. For example line 1 starts with **1===**.
4. If the code is correct, press **Ctrl+D** to run the code and you should once again see the **DS4** LED turn on. If you get a **Line 1 SyntaxError: invalid syntax** error, see [Syntax error at line 1](#). If you wish to exit paste mode without running the code, for example, or if the code did not copy correctly, press **Ctrl+C** to cancel and return to the normal MicroPython `>>>` prompt.
5. Next turn the LED off. Copy the code below:

```
from machine import Pin
led = Pin("D4", Pin.OUT, value=1)
```

```
print("DS4 LED now OFF!")
print("Paste Mode Successful!")
```

6. Press **Ctrl+E** to enter paste mode.
7. Press **Ctrl + Shift + V** or right-click in the Terminal and select **Paste** to paste the copied code.
8. If the code is correct, press **Ctrl+D** to run it. The LED should turn off and you should see two confirmation messages print to the screen.

Catch a button press

For this part of the example, you write code that responds to a button press on the XBIB-U-DEV board that comes with the XBee Smart Modem Development Kit. The code monitors the pin connected to the button on the board labeled **SW2**.

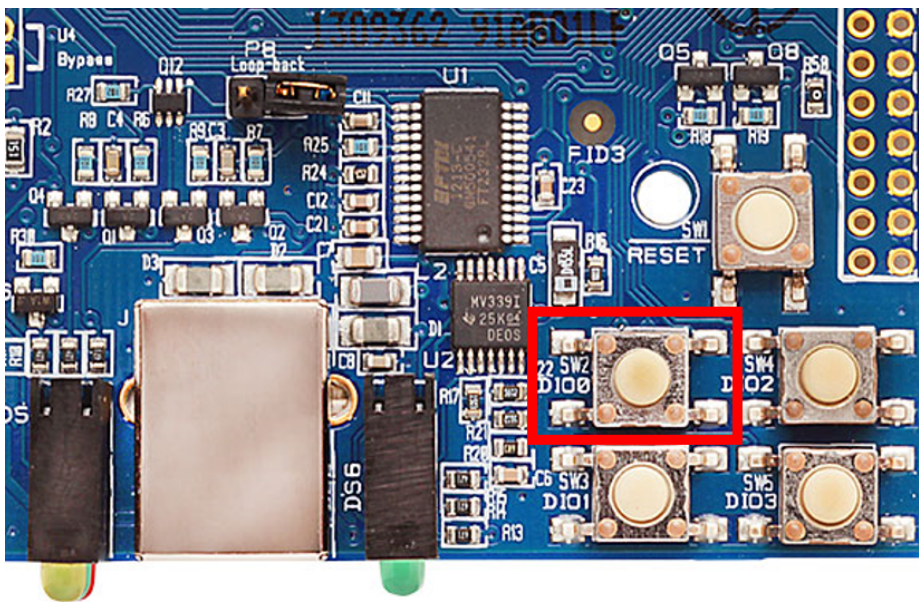

On the board you see **DIO0** written below **SW2**, to the left of the button. This represents the pin that the button is connected to.

In MicroPython, you will create a pin object for the pin that is connected to the **SW2** button. When you create the pin object, the **DIO0** pin is called **D0** for short.

The loop continuously checks the value on that pin and once it goes to **0** (meaning the button has been pressed) a **print()** call prints the message **Button pressed!** to the screen.

At the MicroPython **>>>** prompt, copy the following code and enter it into MicroPython using [paste mode](#) (**Ctrl+E**), right-click in the Terminal, select **Paste** to paste the copied code, and press **Ctrl+D** to run the code.

```
# Import the Pin module from machine, for simpler syntax.
from machine import Pin

# Create a pin object for the pin that the button "SW2" is connected to.
dio0 = Pin("D0", Pin.IN, Pin.PULL_UP)
# Give feedback to inform user a button press is needed.
print("Waiting for SW2 press...")
```

```
# Create a WHILE loop that checks for a button press.
while (True):
    if (dio0.value() == 0): # Once pressed.
        print("Button pressed!") # Print message once pressed.
        break # Exit the WHILE loop.

# When you press SW2, you should see "Button pressed!" printed to the
screen.
# You have successfully performed an action in response to a button press!
```

Note You can easily copy and paste code from the [online version of this guide](#). Use caution with the PDF version, as it may not maintain essential indentations.

Note If you have problems pasting the code, see [Syntax error at line 1](#). For SMS failures, see [Error Failed to send SMS](#).

Send a text (SMS) when the button is pressed

After [creating a while loop](#) that checks for a button press, add sending an SMS to your code. Instead of printing **Button pressed!** to the screen, this code sends **Button pressed** to a cell phone as a text (SMS) message.

To accomplish this, use the `sms_send()` method, which sends a string to a given phone number. It takes the arguments in the following order:

1. **<phone number>**
2. **<message-to-be-sent>**

Before you run this part of the example, you must create a variable that holds the phone number of the cell phone or mobile device you want to receive the SMS.

1. To do this, at the MicroPython `>>>` prompt, type the following command, replacing **1123456789** with the full phone number (no dashes, spaces, or other symbols) and press **Enter**:

```
ph = 1123456789
```

2. After you create this **ph** variable with your phone number, copy the code below and enter it into MicroPython using [paste mode \(Ctrl+E\)](#) and then run it.
-

```
from machine import Pin
import network # Import network module
import time

c = network.Cellular() # initialize cellular network parameter
dio0 = Pin("D0", Pin.IN, Pin.PULL_UP)
while not c.isconnected(): # While no network connection.
    print("Waiting for connection to cell network...")
    time.sleep(5)
print("Connected.")
# Give feedback to inform user a button press is needed.
print("Waiting for SW2 press...")
while (True):
    if (dio0.value() == 0):
        # When SW2 is pressed, the module will send an SMS
        # message saying "Button pressed" to the given target cell phone
```

```

number.
    try:
        c.sms_send(ph, 'Button Pressed')
        print("Sent SMS successfully.")
    except OSError:
        print("ERROR- failed to send SMS.")
        # Exit the WHILE loop.
        break

```

Note You can easily copy and paste code from the [online version of this guide](#). Use caution with the PDF version, as it may not maintain essential indentations.

Note If you have problems pasting the code, see [Syntax error at line 1](#). For SMS failures, see [Error Failed to send SMS](#).

Add the time the button was pressed

After you [add the ability to send an SMS](#) to the code, add functionality to insert the time at which the button was pressed into the SMS that is sent. To accomplish this:

1. Create a UDP socket with the **socket()** method.
2. Save the IP address and port of the time server in the **addr** variable.
3. Connect to the time server with the **connect()** method.
4. Send **hello** to the server to prompt it to respond with the current date and time.
5. Receive and store the date/time response in the **buf** variable.
6. Send an SMS in the same manner as before using the **sms_send()** method, except that you add the time into the SMS message, such that the message reads: **[Button pressed at: YYYY-MM-DD HH:MM:SS]**

To verify that your phone number is still in the memory, at the MicroPython **>>>** prompt, type **ph** and press **Enter**.

If MicroPython responds with your number, copy the following code and enter it into MicroPython using [paste mode](#) and then run it. If it returns an error, enter your number again as shown in [Send a text \(SMS\) when the button is pressed](#). With your phone number in memory in the **ph** variable, copy the code below and enter it into MicroPython using [paste mode \(Ctrl+E\)](#) and then run it.

```

from machine import Pin
import network
import usocket
import time

c = network.Cellular()
dio0 = Pin("D0", Pin.IN, Pin.PULL_UP)
while not c.isconnected(): # While no network connection.
    print("Waiting for connection to cell network...")
    time.sleep(5)
print("Connected.")
# Give feedback to inform user a button press is needed.
print("Waiting for SW2 press...")
while (1):
    if (dio0.value() == 0):

```

```

# When button pressed, now the module will send "Button Press" AND
# the time at which it was pressed in an SMS message to the given
# target cell phone number.
socketObject = usocket.socket(usocket.AF_INET, usocket.SOCK_DGRAM)
# Connect the socket object to the web server specified in
"address".
addr = ("52.43.121.77", 10002)
socketObject.connect(addr)
bytessent = socketObject.send("hello")
print("Sent %d bytes on socket" % bytessent)
buf = socketObject.recv(1024)
# Send message to the given number. Handle error if it occurs.
try:
    c.sms_send(ph, 'Button Pressed at: ' + str(buf))
    print("Sent SMS successfully.")
except OSError:
    print("ERROR- failed to send SMS.")
# Exit the WHILE loop.
break

```



Note You can easily copy and paste code from the [online version of this guide](#). Use caution with the PDF version, as it may not maintain essential indentations.

Now you have a system based on the XBee Smart Modem that sends an SMS in response to a certain input, in this case a simple button press.

Note If you have problems pasting the code, see [Syntax error at line 1](#). For SMS failures, see [Error Failed to send SMS](#).

Exit MicroPython mode

To exit MicroPython mode:

1. In the XCTU MicroPython Terminal, click the green **Close** button .
2. Click **Close** at the bottom of the terminal to exit the terminal.
3. In XCTU's Configuration working mode , change **AP API Enable** to another mode and click the **Write** button . We recommend changing to Transparent mode [0], as most of the examples use this mode.

Other terminal programs

If you do not use the MicroPython Terminal in XCTU, you can use other terminal programs to communicate with the XBee Smart Modem. If you use Microsoft Windows, follow the instructions for Tera Term, if you use Linux, follow the instructions for picocom. To download these programs:

- Tera Term for Windows; see <https://tssh2.osdn.jp/index.html.en>.
- Picocom for Linux; see https://developer.ridgerun.com/wiki/index.php/Setting_up_Picocom_-_Ubuntu and for the source code and in-depth information <https://github.com/npat-efault/picocom>.

Tera Term for Windows

With the XBee Smart Modem in MicroPython mode (**AP = 4**), you can access the MicroPython prompt using a terminal.

1. Open Tera Term. The **Tera Term: New connection** window appears.
2. Click the **Serial** radio button to select a serial connection.
3. From the **Port:** drop-down menu, select the COM port that the XBee Smart Modem is connected to.
4. Click **OK**. The **COMxx - Tera Term VT** terminal window appears and Tera Term attempts to connect to the device at a baud rate of 9600 b/s. The terminal will not allow communication with the device since the baud rate setting is incorrect. You must change this rate as it was previously set to 115200 b/s.
5. Click **Setup** and **Serial Port**. The **Tera Term: Serial port setup** window appears.

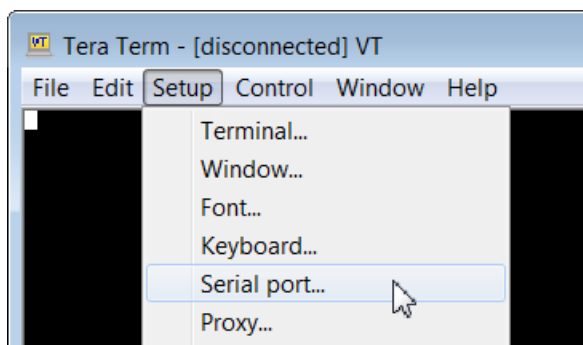

6. In the **Tera Term: Serial port setup** window, set the parameters to the following values:
 - **Port:** Shows the port that the XBee Smart Modem is connected on.
 - **Baud rate:** 115200
 - **Data:** 8 bit
 - **Parity:** none
 - **Stop:** 1 bit
 - **Flow control:** hardware
 - **Transmit delay:** N/A
7. Click **OK** to apply the changes to the serial port settings. The settings should go into effect right away.
8. To verify that local echo is not enabled and that extra line-feeds are not enabled:
 - a. In Tera Term, click **Setup** and select **Terminal**.
 - b. In the **New-line** area of the **Tera Term: Serial port setup** window, click the **Receive** drop-down menu and select **CR** if it does not already show that value.
 - c. Make sure the **Local echo** box is not checked.
9. Click **OK**.
10. Press **Ctrl+B** to get the MicroPython version banner and prompt.

```
MicroPython v1.8.7 on 2017-04-06; XBee Cellular with EFM32G
Type "help()" for more information.
>>>
```

Now you can type MicroPython commands at the >>> prompt.

Use picocom in Linux

With the XBee Smart Modem in MicroPython mode (**AP = 4**), you can access the MicroPython prompt using a terminal.

Note The user must have read and write permission for the serial port the XBee Smart Modem is connected to in order to communicate with the device.

1. Open a terminal in Linux and type **picocom -b 115200 /dev/ttyUSB0**. This assumes you have no other USB-to-serial devices attached to the system.
2. Press **Ctrl+B** to get the MicroPython version banner and prompt. You can also press **Enter** to bring up the prompt.

If you do have other USB-to-serial devices attached:

1. Before attaching the XBee Smart Modem, check the directory **/dev/** for any devices named **ttUSBx**, where **x** is a number. An easy way to list these is to type: **ls /dev/ttyUSB***. This produces a list of any device with a name that starts with **ttUSB**.
2. Take note of the devices present with that name, and then connect the XBee Smart Modem.
3. Check the directory again and you should see one additional device, which is the XBee Smart Modem.
4. In this case, replace **/dev/ttyUSB0** at the top with **/dev/ttyUSB<number>**, where **<number>** is the new number that appeared.
5. It should connect and show Terminal ready.

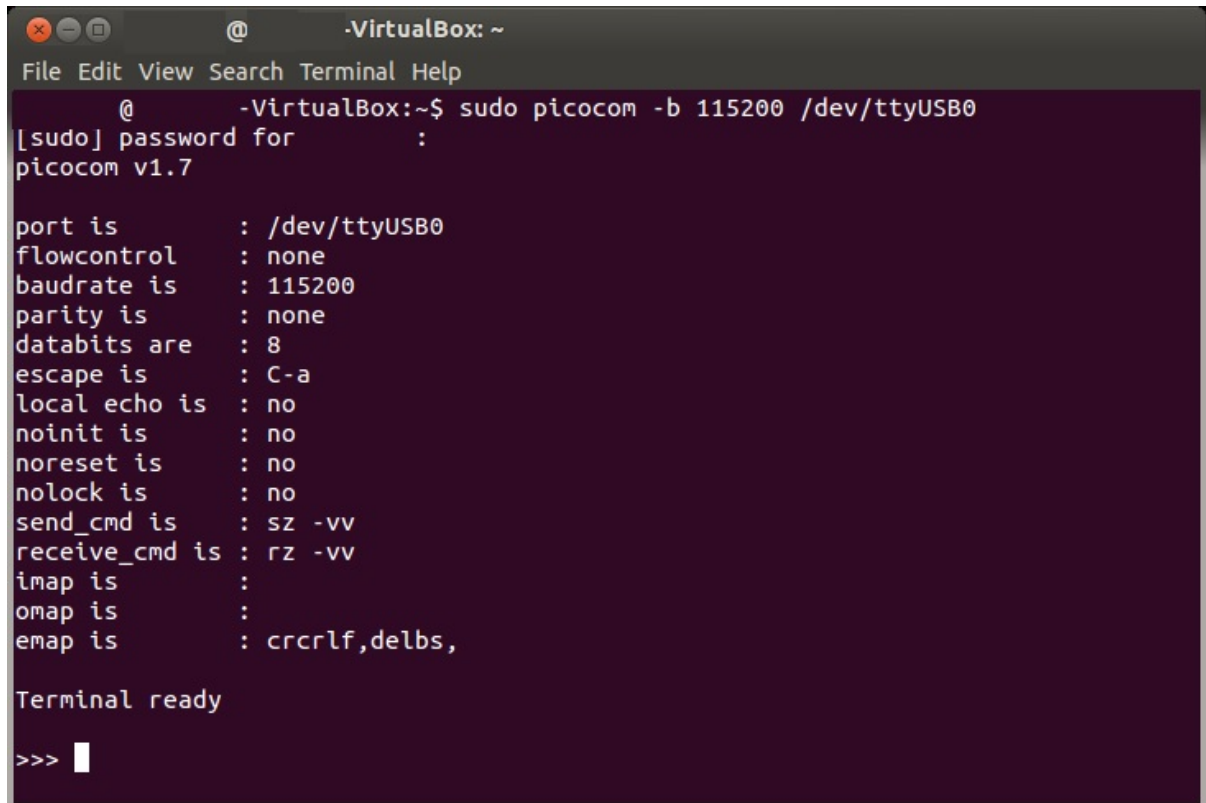

```
-VirtualBox: ~
File Edit View Search Terminal Help
@ -VirtualBox:~$ sudo picocom -b 115200 /dev/ttyUSB0
[sudo] password for :
picocom v1.7

port is      : /dev/ttyUSB0
flowcontrol  : none
baudrate is  : 115200
parity is    : none
databits are : 8
escape is    : C-a
local echo is : no
noinit is    : no
noreset is   : no
nolock is    : no
send_cmd is  : SZ -vv
receive_cmd is : rZ -vv
imap is      :
omap is      :
emap is      : crclrf,delbs,

Terminal ready

>>> █
```

Now you can type MicroPython commands at the >>> prompt.

Technical specifications

Interface and hardware specifications	60
RF characteristics	60
Networking specifications	60
Power requirements	60
Power consumption	61
Electrical specifications	61
Regulatory approvals	62

Interface and hardware specifications

The following table provides the interface and hardware specifications for the device.

Specification	Value
Dimensions	2.438 x 3.294 cm (0.960 x 1.297 in)
Weight	5 g (0.18 oz)
Operating temperature	-40 to +80 °C
Antenna connector	U.FL for primary and secondary antennas
Digital I/O	13 I/O lines
ADC	4 10-bit analog inputs

RF characteristics

The following table provides the RF characteristics for the device.

Specification	Cellular value	Bluetooth value
Modulation	LTE/4G – QPSK, 16 QAM	QPSK
Transmit power	23 dBm	9 dBm
Receive sensitivity	-102 dBm	-92 dBm
Over-the-air maximum data rate	10 Mb/s	2 Mb/s

Networking specifications

The following table provides the networking and carrier specifications for the device.

Specification	Value
Addressing options	TCP/IP and SMS
Carrier and technology	AT&T LTE Cat 1
Supported bands	2, 4 and 12
Security	SSL/TLS

Power requirements

The following table provides the power requirements for the device.

Specification	Value
Supply voltage range	3.0 to 5.5 VDC
Extended voltage range	2.7 to 5.5 VDC

Power consumption

Specification	State	Average current	Peak current
2.4 GHz TX	Active transmit @ 3.3 V	70 mA	
2.4 GHz RX	Active receive @ 3.3 V	30 mA	
Cellular Tx+RX current	Active transmit, 23 dBm @ 3.3 V	860 mA	1020 mA, Bluetooth disabled 1080 mA, Bluetooth enabled
Cellular Tx+RX current	Active transmit, 23 dBm @ 5.0 V	555 mA	630 mA, Bluetooth disabled 680 mA, Bluetooth enabled
Cellular TX Only current	Active transmit, 23 dBm @ 3.3 V	680 mA	N/A
Cellular Rx + ACK current	Active receive @ 3.3 V	530 mA	N/A
Cellular Rx + ACK current	Active receive @ 5 V	360 mA	N/A
Cellular RX Only current	Active receive @ 3.3 V	300 mA	N/A
Idle current	Idle/connected, listening @ 3.3 V	110 mA	N/A
Idle current	Idle/connected, listening @ 5 V	75 mA	N/A
Sleep current	Not connected, Deep Sleep @ 3.3 V	12 μ A	N/A

Electrical specifications

The following table provides the electrical specifications for the XBee Smart Modem.

Symbol	Parameter	Condition	Min	Typical	Max	Units
VCCMAX	Maximum limits of VCC line		0		5.5	V
VDD_IO	Internal supply voltage for I/O	While in deep sleep and during initial power up	Min (VCC-0.3, 3.3)		3.3	V
VDD_IO	Internal supply voltage for I/O	In normal running mode		3.3 V		V

Symbol	Parameter	Condition	Min	Typical	Max	Units
VI	Voltage on 5 V tolerant pins	XBee pin 6	0.3		Min (5.25, VDD_IO+2) ¹	V
	Other input pins		0.3		VDD_IO + 0.3	V
VIL	Input low voltage				0.3*VDD_IO	V
VIH	Input high voltage		0.7*VDD_IO			V
VOL	Voltage output low	Sinking 3 mA VDD_IO = 3.3 V			0.2*VDD_IO	V
VOH	Voltage output high	Sourcing 3 mA VDD_IO = 3.3 V	0.8*VDD_IO			V
I_IN	Input leakage current	High Z state I/O connected to Ground or VDD_IO		0.1	100	nA
RPU	Internal pull-up resistor	Enabled		40		kΩ
RPD	Internal pull-down resistor	Enabled		40		kΩ

Regulatory approvals

The following table provides the regulatory and carrier approvals for the device.

Specification	Value
Model	XB3C1
United States	FCC ID: MCQ-XB3C1 Contains FCC ID:RI7XE866A1NA
Innovation, Science and Economic Development Canada (ISED)	IC: 1846A-XB3C1 Contains IC: 5131A-XE866A1NA
Europe (CE)	N/A
RoHS	Lead-free and RoHS compliant
Australia	N/A
Verizon end-device certified	No
AT&T end-device certified	Yes
PTCRB end-device certified	Yes

¹Pin 6 is also 5 V tolerant even when the XBee Smart Modem is not powered. We recommend only driving this pin with 3.3 V for compatibility with other XBee products. The VBUS line is not used to enable/disable USB on this product.

Hardware

Mechanical drawings	64
Pin signals	64
RSSI PWM	66
SIM card	66
The Associate LED	66

Mechanical drawings

The following figures show the mechanical drawings for the XBee Smart Modem. All dimensions are in inches.

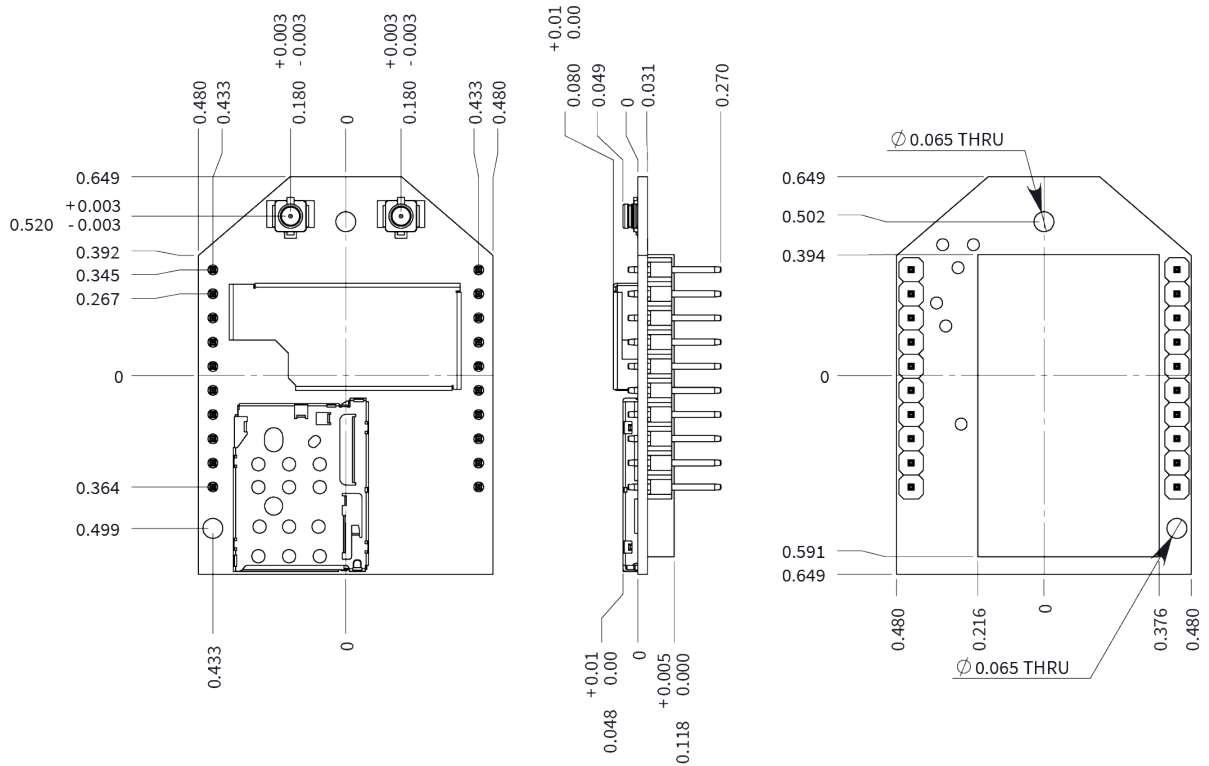

Pin signals

The pin locations are:

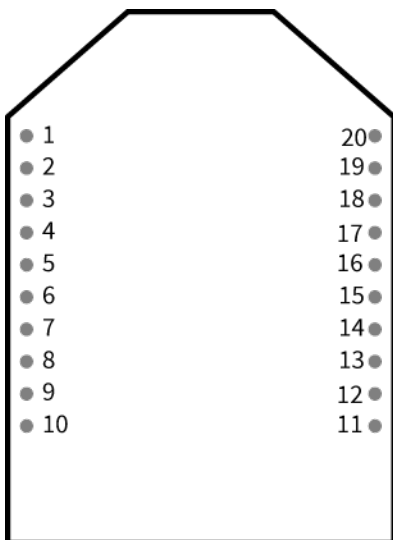

The following table shows the pin assignments for the through-hole device. In the table, low-asserted signals have a horizontal line above signal name.

Pin	Name	Direction	Default	Description
1	V _{CC}			Power supply
2	DOUT	Output	Output	UART Data Out
3	DIN / $\overline{\text{CONFIG}}$	Input	Input	UART Data In
4	DIO12 / SPI_MISO	Either	Disabled	Digital I/O 12 or SPI Slave Output line ¹
5	$\overline{\text{RESET}}$	Input		
6	PWM0 / RSSI / DIO10/USB_VBUS	Either	Output	PWM Output 0 / RX Signal Strength Indicator / Digital I/O 10
7	DIO11/USB D+	Either	Disabled	Digital I/O 11 or USB Direct D+ line
8	USB D-			USB Direct D- line
9	$\overline{\text{DTR}}$ / SLEEP_RQ/ DIO8	Either	Disabled	Pin Sleep Control Line or Digital I/O 8
10	GND			Ground
11	DIO4 / SPI_MOSI	Either	Disabled	Digital I/O 4 or SPI Slave Input Line
12	$\overline{\text{CTS}}$ / DIO7	Either	Output	Output Clear-to-Send Flow Control or Digital I/O 7
13	ON / $\overline{\text{SLEEP}}$ /DIO9	Output	Output	Module Status Indicator or Digital I/O 9
14	VREF	-		Feature not supported on this device. Used on other XBee devices for analog voltage reference.
15	Associate / DIO5	Either	Output	Associated Indicator, Digital I/O 5
16	$\overline{\text{RTS}}$ / DIO6	Either	Disabled	Input Request-to-Send Flow Control, Digital I/O 6
17	$\overline{\text{AD3}}$ / DIO3 / SPI_SS	Either	Disabled	Analog Input 3 or Digital I/O 3, SPI low enabled select line
18	AD2 / DIO2 / SPI_CLK	Either	Disabled	Analog Input 2 or Digital I/O 2, SPI Clock line
19	$\overline{\text{AD1}}$ / DIO1 / SPI_ATTN	Either	Disabled	Analog Input 1 or Digital I/O 1, SPI Attention line output
20	AD0 / DIO0	Either	Input	Analog Input 0, Digital I/O 0

Pin connection recommendations

To ensure compatibility with future updates, make USB D+ and D- (pin 7 and pin 8) available in your design.

¹DIO12/SPI_MISO and DIO4/SPI_MOSI (pin 4 and pin 11) may optionally be configured as a secondary UART serial port using MicroPython. See the [Digi MicroPython Programming Guide](#) for details.

The recommended minimum pin connections are VCC, GND, DIN, DOUT, $\overline{\text{RTS}}$, $\overline{\text{DTR}}$ and $\overline{\text{RESET}}$. Firmware updates require access to these pins.

RSSI PWM

The XBee Smart Modem features an RSSI/PWM pin (pin 6) that, if enabled, adjusts the PWM output to indicate the signal strength of the cellular connection. Use [P0 \(DIO10/PWM0 Configuration\)](#) to enable the RSSI pulse width modulation (PWM) output on the pin. If **P0** is set to 1, the RSSI/PWM pin outputs a PWM signal where the frequency is adjusted based on the received signal strength of the cellular connection.

The RSSI/PWM output is enabled continuously unlike other XBee products where the output is enabled for a short period of time after each received transmission. If running on the XBIB development board, DIO10 is connected to the RSSI LEDs, which may be interpreted as follows:

PWM duty cycle	Number of LEDs turned on	Received signal strength (dBm)
79.39% or more	3	-83 dBm or higher
62.42% to 79.39%	2	-93 to -83 dBm
45.45% to 62.42%	1	-103 to -93 dBm
Less than 45.45%	0	Less than -103 dBm, or no cellular network connection

SIM card

The XBee Smart Modem uses a 4FF (Nano) size SIM card.



CAUTION! Never insert or remove SIM card while the power is on!

The Associate LED

The following table describes the Associate LED functionality. For the location of the Associate LED on the XBIB-U development board, see number 6 on the [XBIB-U-DEV reference](#).

LED status	Blink timing	Meaning
On, solid		Not joined to a mobile network.
Double blink	½ second	The last TCP/UDP/SMS attempt failed. If the LED has this pattern, you may need to check DI (Remote Manager Indicator) or CI (Protocol/Connection Indication) for the cause of the error.
Standard single blink	1 second	Normal operation.

The normal association LED signal alternates evenly between high and low as shown below:



Where the low signal means LED off and the high signal means LED on.

When **CI** is not **0** or **0xFF**, the Associate LED has a different blink pattern that looks like this:



Antenna recommendations

Antenna connections	69
Keepout area	70
Antenna placement	71

Antenna connections



CAUTION! The XBee Smart Modem will not function properly with only the secondary antenna port connected!

The XBee Smart Modem has two U.FL antenna ports; a primary on the upper left of the board and a secondary port on the upper right, see the drawing below. You must connect the primary port and the secondary port is optional. The secondary antenna improves receive performance in certain situations, so we recommend it for best results.

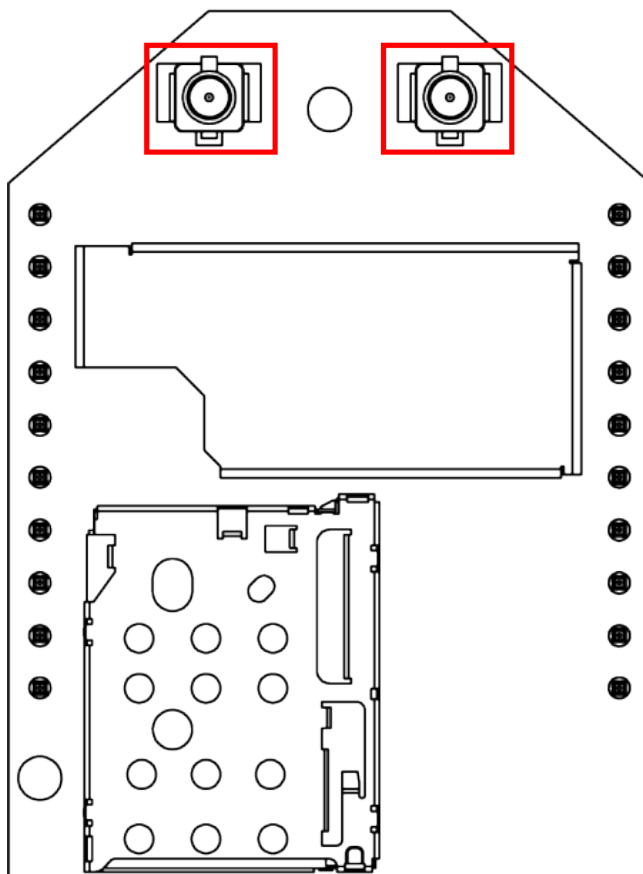

See [FCC-approved antennas](#) for a list of approved antennas.

Connect the antenna cables as shown below.



WARNING! If you must run cables through the keepout area, keep them out of the left area, and do not cover the embedded antennas.

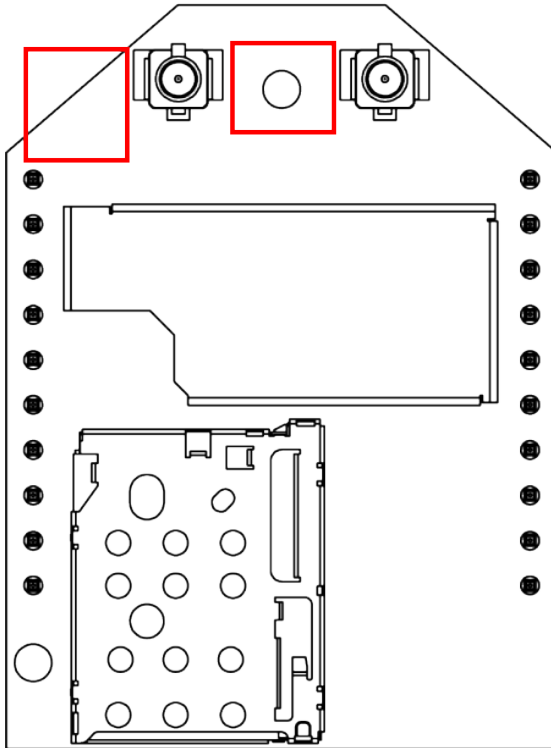

Keepout area

The following drawing shows important recommendations for designing with the PCB antenna module using an embedded antenna for Bluetooth. Do not mount the surface-mount PCB antenna module on the RF Pad footprint because that footprint requires a ground plane within the keepout area.

Through-hole keepout

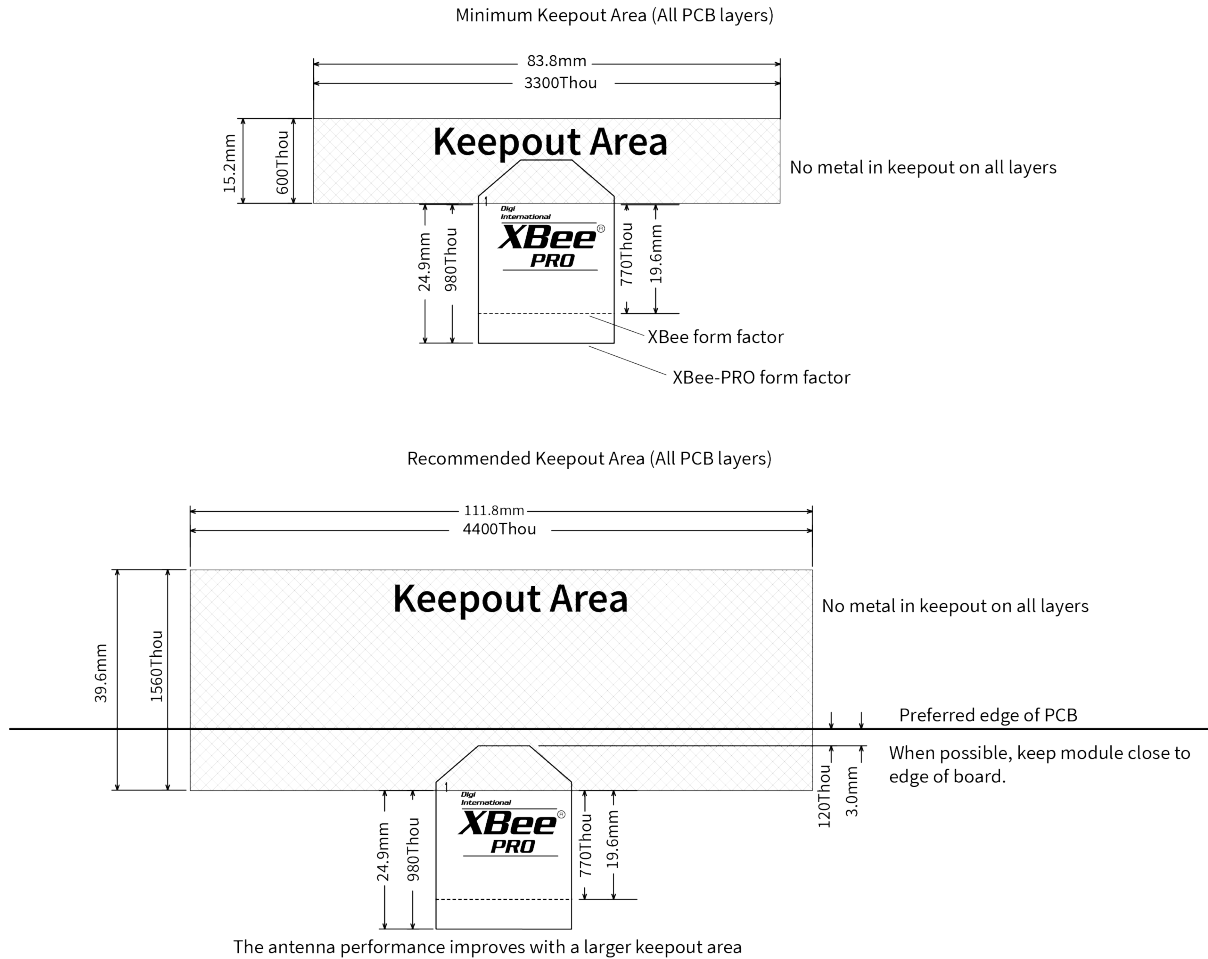

Notes

1. We recommend non-metal enclosures. For metal enclosures, use an external antenna.
2. Keep metal chassis or mounting structures in the keepout area at least 2.54 cm (1 in) from the antenna.
3. Maximize the distance between the antenna and metal objects that might be mounted in the keepout area.
4. These keepout area guidelines do not apply for wire whip antennas or external RF connectors. Wire whip antennas radiate best over the center of a ground plane.

Antenna placement

For optimal cellular reception, keep the antenna as far away from metal objects and other electronics (including the XBee Smart Modem) as possible. Often, small antennas are desirable, but come at the cost of reduced range and efficiency.

Design recommendations

Cellular component firmware updates	73
USB Direct design	73
Power supply considerations	73
Recommended application circuit	74
Heat considerations and testing	74
Heat sink guidelines	75
Add a fan to provide active cooling	76

Cellular component firmware updates

Even if you do not plan to use the USB interface (Pin 7 and 8), we strongly recommend you provide a way to access the USB pins (Pin 7 and 8) to support direct firmware updates of the Cellular modem. You should keep Pins 7 and 8 routing as a 90 ohm diff pair for USB communications.



CAUTION! If you do not provide access to these USB pins, you may be unable to perform cellular component firmware updates.

One way to provide access to the USB interface is to connect the USB pins to a header or USB connector on the host design; see [USB Direct design](#) for more information. At a minimum you should connect pins 7 and 8 to test points so they are easy to wire to a connector if necessary.

If you are using the USB pins for other purposes you must provide a way to disconnect those interfaces during USB operation, such as using zero ohm resistors.

USB Direct design

Connect USB data pins 7 and 8 (USB_D+ and USB_D- respectively) on the XBee Smart Modem to the appropriate pins on the host processor or connector. You may optionally connect pin 6 to VBUS for future compatibility, but the VBUS feature is not supported on this product. See [USB direct mode](#) for more information on how USB is enabled and disabled.

The USB interface follows the USB 2.0 high speed specification and data lines must be designed as a 90 Ω differential pair. Both traces should be the same length and the overall trace length should be kept as short as possible. If you are connecting to a USB connector then we recommend that you employ an ESD suppressor appropriate for USB 2.0 HS (for example the Littelfuse PESD0402-140). Other than the ESD suppressor, do not place additional components in the signal paths. The suppressor is not needed if you are connecting to an on-board host processor.



CAUTION! If you use pins 7 and 8 for USB you must dedicate the pins to that interface. Adding any traces to the main USB trace and/or connecting those traces to other components will introduce signal integrity issues, which may result in unreliable USB operation.

Power supply considerations

When considering a power supply, use the following design practices.

1. Power supply ripple should be less than 75 mV peak to peak.
2. The power supply should be capable of providing a minimum of 1.5 A at 3.3 V (5 W). Keep in mind that operating at a lower voltage requires higher current capability from the power supply to achieve the 5 W requirement.
3. Place sufficient bulk capacitance on the XBee VCC pin to maintain voltage above the minimum specification during inrush current. Inrush current is about 2 A during initial power up of cellular communications and wakeup from sleep mode.
4. Place smaller high frequency ceramic capacitors very close to the XBee Smart Modem VCC pin to decrease high frequency noise.

5. Use a wide power supply trace or power plane to ensure it can handle the peak current requirements with minimal voltage drop. We recommend that the power supply and trace be designed such that the voltage at the XBee VCC pin does not vary by more than 0.1 V between light load (~0.5 W) and heavy load (~3 W).

Recommended application circuit

In high EMI noise environments, we recommend adding a 10 nF ceramic capacitor very close to pin 5.

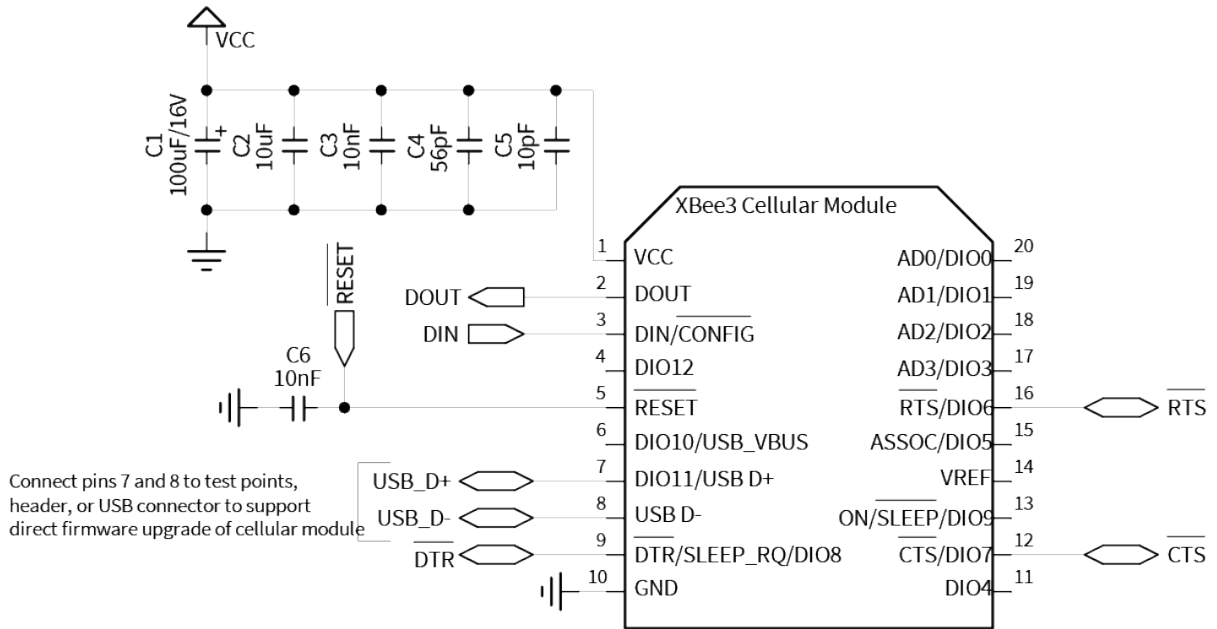

Heat considerations and testing

The XBee Smart Modem may generate significant heat during sustained operation. In addition to heavy data transfer, other factors that can contribute to heating include ambient temperature, air flow around the device, and proximity to the nearest cellular tower (the XBee Smart Modem must transmit at a higher power level when communicating over long distances). Overheating can cause device malfunction and potential damage. In order to avoid this it is important to consider the application the XBee Smart Modem is going into and mitigate heat issues if necessary. We recommend that you perform thermal testing in your application to determine the resulting steady state temperature of the XBee Smart Modem. Use [TP \(Temperature\)](#) to estimate the device temperature. Convert the **TP** reading from hex format to decimal.

You also need to know the ambient temperature and the average current consumption during your test. If you do not have a way to measure current consumption you can estimate it from the table in the next section.

Use those results to approximate the maximum safe ambient temperature for the XBee Smart Modem, $T_{MAX,amb}$, with the following equation:

$$T_{MAX,amb} = 80^{\circ}\text{C} - (T_{XBee} - T_{amb,test}) \left(\frac{I_{MAX}}{I_{AVG,test}} \right)$$

Where:

T_{XBee} is the steady state temperature of the XBee Smart Modem that you measured during your test (if using the **TP** command, be sure to convert from hex format to decimal).

$T_{amb,test}$ is the ambient air temperature during your test.

$I_{AVG,test}$ is the average current measured during your test.

I_{MAX} is the average current draw expected for your application when transmitting at maximum RF power; see [Power consumption](#).

Heat sink guidelines

Based on the results of your thermal testing you may find it is advisable or required to implement a method of dissipating excess heat. This section explains how to employ a heat sink on top of the XBee Smart Modem.

A bolt-down style heat sink on top of the XBee Smart Modem provides the best performance. An example part number is Advanced Thermal Solutions ATS-PCBT1084/ATS-PCB1084. You must use an electrically non-conductive thermal gasket on top of the XBee device under the area that will be covered by the heat sink. A thermal gasket such as Gap Pad® 2500S20 is suitable for this purpose. We recommend using a gasket with thickness of at least 0.080 in to ensure that components on top of the XBee device do not tear through the material when pressure is applied to the heat sink.

Install the SIM card prior to placement of the heat sink. Position the thermal gasket and heat sink assembly on the top of the device so that it covers the entire section shown inside the blue box below (covering the RF shield with thermal gasket is optional because the RF shield is allowed to directly contact the heat sink). Do not cover the U.FL connectors.

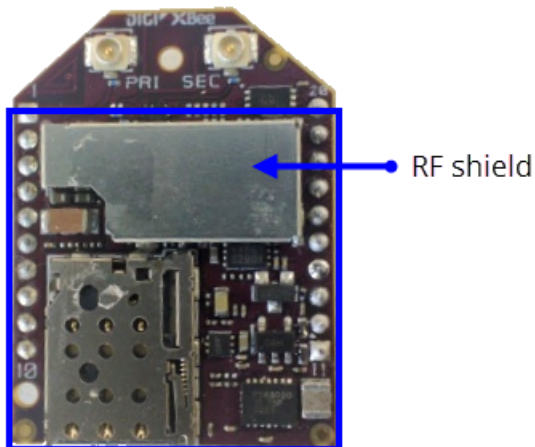

When attaching to the host PCB, tighten the mounting hardware until the gasket is compressed at least 25% and the heat sink is snug against the RF shield. Avoid overtightening. To prevent shorting, check that the surface of the heat sink does not directly contact any of the XBee device components.

You may also use an adhesive style heat sink with the XBee Smart Modem, such as Wakefield-Vette 658-45ABT3. Follow the instructions above, except do not cover the area under the RF shield with thermal gasket; connect this surface directly to the heat sink for mechanical strength. The thermal gasket must be used on top of all other components under the heat sink to prevent shorting and provide effective thermal transfer to the heat sink.

The following table provides a list of typical scenarios and the maximum ambient temperature at which the XBee Smart Modem can be safely operated under that condition. These are provided only as guidelines as your results will vary based on application. We recommend that you perform sufficient

testing, as explained in Heat considerations and testing, to ensure that the XBee Smart Modem does not exceed temperature specifications.

Scenario	Average current consumption (VCC = 3.3V)	Example application	Peak data consumed (MB/hr)	Maximum safe ambient temperature		
				No heat sink	Heat sink	Heat sink and fan
Maximum transmission duty cycle	950 mA	Running video camera	500 to 2000	N/A	40 C	60 C
50% duty cycle	475 mA	Running low resolution video camera	200 to 400	42 C	65 C	75 C
20% duty cycle	200 mA	Sending high resolution photo less than once per minute	50 to 150	64 C	74 C	78 C
Device awake, limited transmissions	170 mA	Updating traffic sign	1 to 10	66 C	75 C	80 C
Device primarily asleep, very limited transmissions	20 mA	Small data transmission/receptions which occur once per hour	Less than 0.1	80 C	80 C	80 C

Add a fan to provide active cooling

Another option for heat mitigation is to add a fan to your system to provide active cooling. You can use a fan instead of or in addition to a heat sink. The XBee Smart Modem offers a fan control feature on I/O pin DIO11 (pin 7). When the functionality is enabled, that line is pulled high to indicate when the fan should be turned on. The line is pulled high when the device gets above 70 °C and the cellular component is running, and turns off when the device drops below 65 °C.

To enable the functionality set [P1 \(DIO11/PWM1 Configuration\)](#) to **1**. Note that the I/O pin is not capable of driving a fan directly; you must implement a circuit to power the fan from a suitable power source.

Cellular connection process

Connecting	78
Data communication with remote servers (TCP/UDP)	78
Disconnecting	78
SMS encoding	79

Connecting

In normal operations, the XBee Smart Modem automatically attempts both a cellular network connection and a data network connection on power-up. The sequence of these connections is as follows:

Cellular network

1. The device powers on.
2. It looks for cellular towers.
3. It chooses a candidate tower with the strongest signal.
4. It negotiates a connection.
5. It completes cellular registration; the phone number and SMS are available.

Data network connection

1. The network enables the evolved packet system (EPS) bearer with an access point name (APN). See [AN \(Access Point Name\)](#) if you have APN issues. You can use [OA \(Operating APN\)](#) to query the APN value currently configured in the cellular component.
2. The device negotiates a data connection with the access point.
3. The device receives its IP configuration and address.
4. The [AI \(Association Indication\)](#) command now returns a **0** and the sockets become available.

Data communication with remote servers (TCP/UDP)

Once the data network connection is established, communication with remote servers can be initiated in several ways:

- Transparent mode data sent to the serial port (see [TD \(Text Delimiter\)](#) and [RO \(Packetization Timeout\)](#) for timing).
- API mode: [Transmit \(TX\) Request: IPv4 - 0x20](#) received over the serial connection.
- Digi Remote Manager connectivity begins.

Data communication begins when:

1. A socket opens to the remote server.
2. Data is sent.

Data connectivity ends when:

1. The server closes the connection.
2. The **TM** timeout expires (see [TM \(IP Client Connection Timeout\)](#)).
3. The cellular network may also close the connection after a timeout set by the network operator.

Disconnecting

When the XBee Smart Modem is put into Airplane mode or deep sleep is requested:

1. Sockets are closed, cleanly if possible.
2. The cellular connection is shut down.
3. The cellular component is powered off.

Note We recommend entering Airplane mode before resetting or rebooting the device to allow the cellular module to detach from the network.

SMS encoding

The XBee Smart Modem transmits SMS messages using the standard [GSM 03.38](#) character set.¹ Because this character set only provides 7 bits of space per character, the XBee Smart Modem ignores the most significant bit of each octet in an SMS transmission payload.

The device converts incoming SMS messages to ASCII. Characters that cannot be represented in ASCII are replaced with a space (' '), or 0x20 in hex). This includes emoji and other special characters.

¹Also referred to as the GSM 7-bit alphabet.

Modes

Select an operating mode	81
Transparent operating mode	82
API operating mode	82
Bypass operating mode	82
USB direct mode	83
Command mode	83
MicroPython mode	86

Select an operating mode

The XBee Smart Modem interfaces to a host device such as a microcontroller or computer through a logic-level asynchronous serial port. It uses a [UART](#) for serial communication with those devices.

The XBee Smart Modem supports three operating modes: Transparent operating mode, API operating mode, and Bypass operating mode. The default mode is Transparent operating mode. Use the [AP \(API Enable\)](#) command to select a different operating mode.

The following flowchart illustrates how the modes relate to each other.

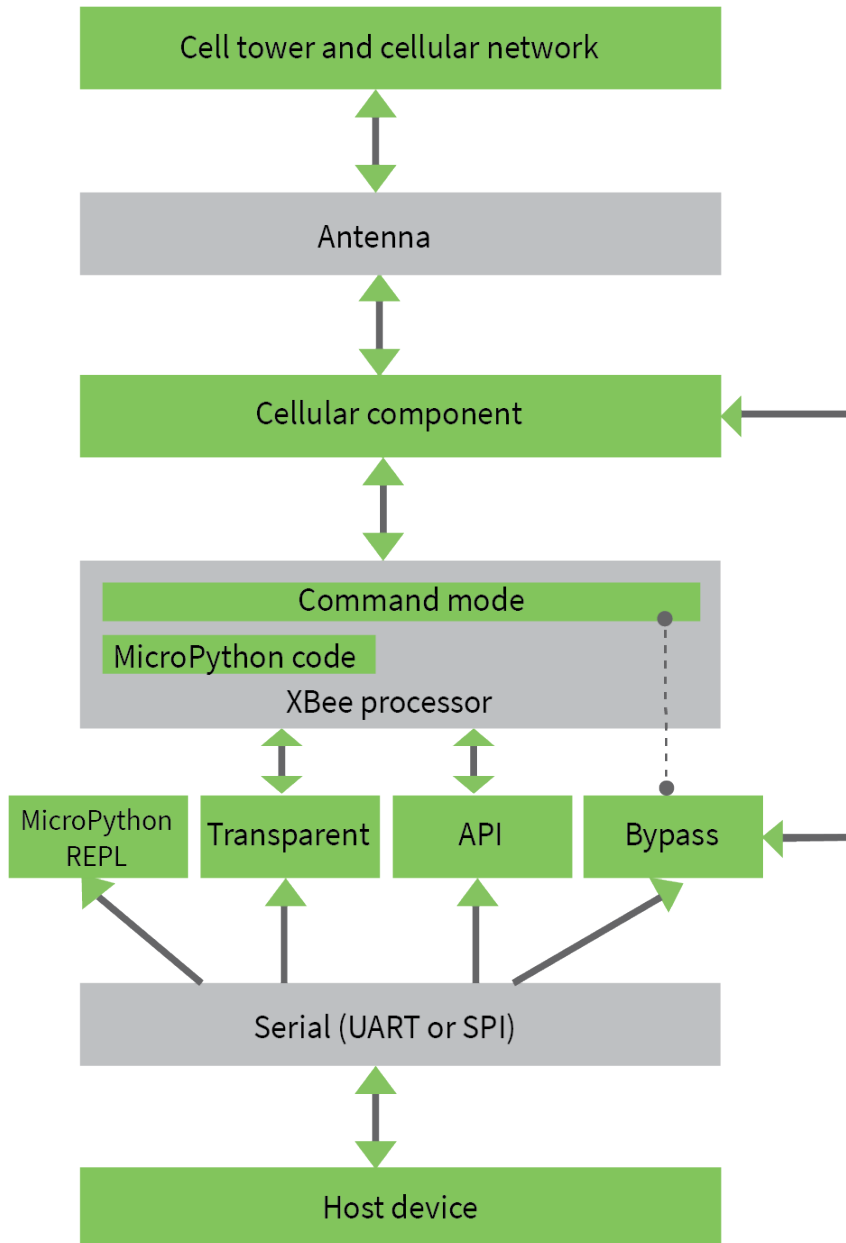

Transparent operating mode

Devices operate in this mode by default. The device acts as a serial line replacement when it is in Transparent operating mode. The device queues all serial data it receives through the DIN pin for RF transmission. When a device receives RF data, it sends the data out through the DOUT pin. You can set the configuration parameters using Command mode.

The [IP \(IP Protocol\)](#) command setting controls how Transparent operating mode works for the XBee Smart Modem.

Note Transparent operation is not available when using SPI.

API operating mode

API operating mode is an alternative to Transparent operating mode. API mode is a frame-based protocol that allows you to direct data on a packet basis. The device communicates UART or SPI data in packets, also known as API frames. This mode allows for structured communications with computers and microcontrollers.

The advantages of API operating mode include:

- It is easier to send information to multiple destinations
- The host receives the source address for each received data frame
- You can change parameters without entering Command mode

Bypass operating mode



CAUTION! Bypass operating mode is an alternative to Transparent and API modes for advanced users with special configuration needs. Changes made in this mode might change or disable the device and we do not recommend it for most users.

In Bypass mode, the device acts as a serial line replacement to the cellular component. In this mode, the XBee Smart Modem exposes all control of the cellular component's AT port through the UART. If you use this mode, you must setup the cellular modem directly to establish connectivity. The modem does not automatically connect to the network.

Note The cellular component can become unresponsive in Bypass mode. See [Unresponsive cellular component in Bypass mode](#) for help in this situation.

When Bypass mode is active, most of the XBee Smart Modem's AT commands do not work. For example, **IM** (IMEI) may never return a value, and **DB** does not update. In this configuration, the firmware does not test communication with the cellular component (which it does by sending AT commands). This is useful in case you have reconfigured the cellular component in a way that makes it incompatible with the firmware. Bypass operating mode exists for users who wish to communicate directly with the cellular component settings and do not intend to use XBee Smart Modem software features such as API mode.

Command mode is available while in Bypass mode; see [Enter Command mode](#) for instructions.

Enter Bypass operating mode

To configure a device for Bypass operating mode:

1. Set the [AP \(API Enable\)](#) parameter value to **5**.
2. Send [WR \(Write\)](#) to write the changes.
3. Send [FR \(Force Reset\)](#) to reboot the device.
4. After rebooting, enter Command mode and verify that Bypass operating mode is active by querying [AI \(Association Indication\)](#) and confirming that it returns a value of **0x2F**.

It may take a moment for Bypass operating mode to become active.

Leave Bypass operating mode

To configure a device to leave Bypass operating mode:

1. Set [AP \(API Enable\)](#) to something other than 5.
2. Send [WR \(Write\)](#) to write the changes.
3. Send [FR \(Force Reset\)](#) to reboot the device.
4. After rebooting, enter Command mode and verify that Bypass operating mode is not active by querying [AI \(Association Indication\)](#) and confirming that it returns a value other than **0x2F**.

Restore cellular settings to default in Bypass operating mode

Send **AT&F1** to reset the cellular component to its factory profile.

USB direct mode

This mode allows you to replace the cellular component with the XBee Smart Modem such that the USB lines are the same through a configuration option.

Enable USB direct mode

Set [P1 \(DIO11/PWM1 Configuration\)](#) to **7** to enable USB direct mode. When set to **7** DIO11/PWM1 (pin 7) brings out the USB D+ signal of the cellular component. The USB D- signal is available on pin 8. With these pins connected to a USB host a direct connection is made to the cellular component which is not mediated by the XBee processor.

When in USB direct mode [AI \(Association Indication\)](#) returns **0x2B**.

Command mode

Command mode is a state in which the firmware interprets incoming characters as commands. It allows you to modify the device's configuration using parameters you can set using AT commands. When you want to read or set any parameter of the XBee Smart Modem using this mode, you have to send an AT command. Every AT command starts with the letters **AT** followed by the two characters that identify the command and then by some optional configuration values.

The operating modes of the XBee Smart Modem are controlled by the [AP \(API Enable\)](#) setting, but Command mode is always available as a mode the device can enter while configured for any of the operating modes.

Command mode is available on the UART interface for all operating modes. You cannot use the SPI interface to enter Command mode.

Enter Command mode

To get a device to switch into Command mode, you must issue the following sequence: **+++** within one second. There must be at least one second preceding and following the **+++** sequence. Both the command character (**CC**) and the silence before and after the sequence (**GT**) are configurable. When the entrance criteria are met the device responds with **OK\r** on UART signifying that it has entered Command mode successfully and is ready to start processing AT commands.

If configured to operate in [Transparent operating mode](#), when entering Command mode the XBee Smart Modem knows to stop sending data and start accepting commands locally.

Note Do not press **Return** or **Enter** after typing **+++** because it interrupts the guard time silence and prevents you from entering Command mode.

When the device is in Command mode, it listens for user input and is able to receive AT commands on the UART. If **CT** time (default is 10 seconds) passes without any user input, the device drops out of Command mode and returns to the previous operating mode. You can force the device to leave Command mode by sending **CN** ([Exit Command mode](#)).

You can customize the command character, the guard times and the timeout in the device's configuration settings. For more information, see [CC \(Command Sequence Character\)](#), [CT \(Command Mode Timeout\)](#) and [GT \(Guard Times\)](#).

Troubleshooting

Failure to enter Command mode is often due to baud rate mismatch. Ensure that the baud rate of the connection matches the baud rate of the device. By default, **BD (Baud Rate)** = **3** (9600 b/s).

There are two alternative ways to enter Command mode:

- A serial break for six seconds enters Command mode. You can issue the "break" command from a serial console, it is often a button or menu item.
- Asserting DIN (serial break) upon power up or reset enters Command mode. XCTU guides you through a reset and automatically issues the break when needed.

Both of these methods temporarily set the device's baud rate to 9600 and return an **OK** on the UART to indicate that Command mode is active. When Command mode exits, the device returns to normal operation at the baud rate that **BD** is set to.

Send AT commands

Once the device enters Command mode, use the syntax in the following figure to send AT commands. Every AT command starts with the letters **AT**, which stands for "attention." The AT is followed by two characters that indicate which command is being issued, then by some optional configuration values.

To read a parameter value stored in the device's register, omit the parameter field.

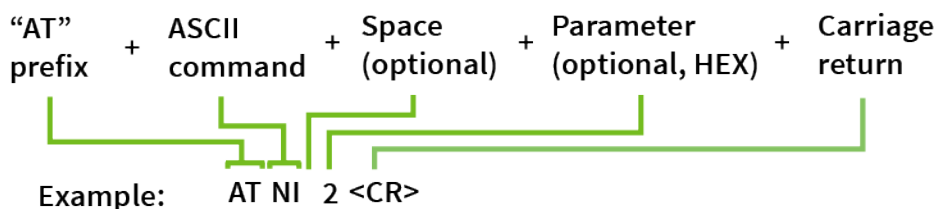

Multiple AT commands

You can send multiple AT commands at a time when they are separated by a comma in Command mode; for example, **ATNIMy XBee,AC<cr>**.

The preceding example changes the **NI (Node Identifier)** to **My XBee** and makes the setting active through **AC (Apply Changes)**.

Parameter format

Refer to the list of **AT commands** for the format of individual AT command parameters. Valid formats for hexadecimal values include with or without a leading **0x** for example **FFFF** or **0xFFFF**.

Response to AT commands

When using AT commands to set parameters the XBee Smart Modem responds with **OK<cr>** if successful and **ERROR<cr>** if not.

For devices with a file system:

ATAP1<cr>

OK<cr>

When reading parameters, the device returns the current parameter value instead of an **OK** message.

ATAP<cr>

1<cr>

Apply command changes

Any changes you make to the configuration command registers using AT commands do not take effect until you apply the changes. For example, if you send the **BD** command to change the baud rate, the actual baud rate does not change until you apply the changes. To apply changes:

1. Send **AC (Apply Changes)**.
 2. Send **WR (Write)**.
- or:
3. **Exit Command mode**.

Make command changes permanent

Send a **WR (Write)** command to save the changes. **WR** writes parameter values to non-volatile memory so that parameter modifications persist through subsequent resets.

Send as **RE command** to wipe settings saved using **WR** back to their factory defaults.

Note You still have to use **WR** to save the changes enacted with **RE**.

Exit Command mode

1. Send **CN (Exit Command mode)** followed by a carriage return.
- or:
2. If the device does not receive any valid AT commands within the time specified by **CT (Command Mode Timeout)**, it returns to Transparent or API mode. The default Command mode timeout is 10 seconds.

For an example of programming the device using AT Commands and descriptions of each configurable parameter, see [AT commands](#).

MicroPython mode

MicroPython mode (**AP = 4**) allows you to communicate with the XBee Smart Modem using the MicroPython programming language. You can use the MicroPython Terminal tool in XCTU to communicate with the MicroPython stack of the XBee Smart Modem through the serial interface.

MicroPython mode connects the primary serial port to the stdin/stdout interface on MicroPython, which is either the REPL or code launched at startup.

When code runs in MicroPython with **AP** set to a value other than **4**, stdout goes to the bit bucket and there is no input to read on stdin.

Sleep modes

About sleep modes	88
Normal mode	88
Pin sleep mode	88
Cyclic sleep mode	88
Cyclic sleep with pin wake up mode	88
Connected sleep mode	88
The sleep timer	89
MicroPython sleep behavior	89

About sleep modes

A number of low-power modes exist to enable devices to operate for extended periods of time on battery power. Use [SM \(Sleep Mode\)](#) to enable these sleep modes.

Normal mode

Set **SM** to 0 to enter Normal mode.

Normal mode is the default sleep mode. If a device is in this mode, it does not sleep and is always awake.

Devices in Normal mode are typically mains powered.

Pin sleep mode

Set **SM** to 1 to enter pin sleep mode.

Pin sleep allows the device to sleep and wake according to the state of the SLEEP_RQ pin (SLEEP_RQ).

When you assert SLEEP_RQ (high), the device finishes any transmit or receive operations, closes any active connection, and enters a low-power state.

When you de-assert SLEEP_RQ (low), the device wakes from pin sleep.

Cyclic sleep mode

Set **SM** to 4 to enter Cyclic sleep mode.

Cyclic sleep allows the device to sleep for a specific time and wake for a short time to poll.

If you use the **D7** command to enable hardware flow control, the $\overline{\text{CTS}}$ pin asserts (low) when the device wakes and can receive serial data, and de-asserts (high) when the device sleeps.

Cyclic sleep with pin wake up mode

Set **SM** to 5 to enter Cyclic sleep with pin wake up mode.

This mode is a slight variation on Cyclic sleep mode (**SM** = 4) that allows you to wake a device prematurely by de-asserting the SLEEP_RQ pin (SLEEP_RQ).

In this mode, you can wake the device after the sleep period expires, or if a high-to-low transition occurs on the SLEEP_RQ pin.

Connected sleep mode

XBee Smart Modem hardware part number XB3-C-A1-UT-xxx can enter Connected sleep mode.

Set bit 0 of [SO \(Sleep Options\)](#) for connected sleep. When bit 0 is set and the XBee Smart Modem goes to sleep, instead of the cellular component shutting down, it enters a lower power consumption mode that maintains registration with the cellular network. This allows significantly faster resumption of communications when coming out of sleep at the cost of additional power used.

Connected sleep mode draws 9 mA during sleep and 11 mA average over time (including periodically waking up to maintain connection).

The sleep timer

The sleep timer starts when the device wakes and resets on re-configuration. When the sleep timer expires the device returns to sleep.

MicroPython sleep behavior

When the XBee Smart Modem enters Deep Sleep mode, any MicroPython code currently executing is suspended until the device comes out of sleep. When the XBee Smart Modem comes out of sleep mode, MicroPython execution continues where it left off.

Upon entering deep sleep mode, the XBee Smart Modem closes any active UDP connections and turns off the cellular component. As a result, any sockets that were opened in MicroPython prior to sleep report as no longer being connected. This behavior appears the same as a typical socket disconnection event will:

- **socket.send** raises **OSError: ENOTCONN**
- **socket.sendto** raises **OSError: ENOTCONN**
- **socket.recv** returns the empty string, the traditional end-of-file return value
- **socket.recvfrom** returns an empty message, for example:
(b'', (<address from connect(>), <port from connect(>))

The underlying UDP socket resources have been released at this point.

Power saving features

Airplane mode	91
---------------------	----

Airplane mode

While not technically a sleep mode, Airplane mode is another way of saving power. When set, the cellular component of the XBee Smart Modem is fully turned off and no access to the cellular network is performed or possible. Use [AM \(Airplane Mode\)](#) to configure this mode.

Serial communication

Serial interface	93
Serial data	93
UART data flow	93
Serial buffers	93
CTS flow control	94
RTS flow control	94
Enable UART or SPI ports	94

Serial interface

The XBee Smart Modem interfaces to a host device through a serial port. The device's serial port can communicate:

- Through a logic and voltage compatible universal asynchronous receiver/transmitter (UART).
- Through a level translator to any serial device, for example, through an RS-232 or USB interface board.
- Through a serial peripheral interface (SPI) port.

Serial data

A device sends data to the XBee Smart Modem's UART through pin 3 DIN as an asynchronous serial signal. When the device is not transmitting data, the signals should idle high.

For serial communication to occur, you must configure the UART of both devices (the microcontroller and the XBee Smart Modem) with compatible settings for the baud rate, parity, start bits, stop bits, and data bits.

Each data byte consists of a start bit (low), 8 data bits (least significant bit first) and a stop bit (high). The following diagram illustrates the serial bit pattern of data passing through the device. The diagram shows UART data packet 0x1F (decimal number 31) as transmitted through the device.

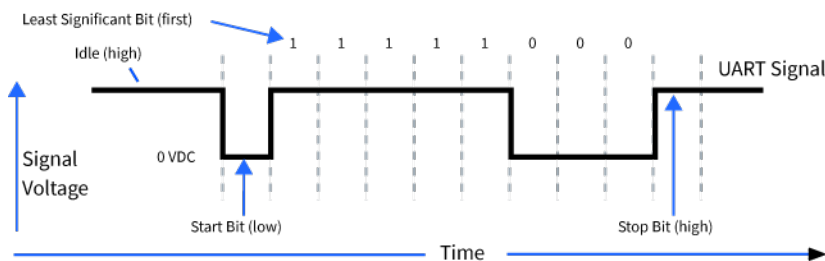

You can configure the UART baud rate, parity, and stop bits settings on the device with the **BD**, **NB**, and **SB** commands respectively. For more information, see [Serial interfacing commands](#).

In the rare case that a device has been configured with the UART disabled, you can recover the device to UART operation by holding DIN low at reset time. DIN forces a default configuration on the UART at 9600 baud and it brings the device up in Command mode on the UART port. You can then send the appropriate commands to the device to configure it for UART operation. If those parameters are written, the device comes up with the UART enabled on the next reset.

UART data flow

Devices that have a UART interface connect directly to the pins of the XBee Smart Modem as shown in the following figure. The figure shows system data flow in a UART-interfaced environment. Low-asserted signals have a horizontal line over the signal name.

Serial buffers

The XBee Smart Modem maintains internal buffers to collect serial and RF data that it receives. The serial receive buffer collects incoming serial characters and holds them until the device can process them. The serial transmit buffer collects the data it receives via the RF link until it transmits that data out the serial or SPI port.

CTS flow control

We strongly encourage you to use flow control with the XBee Smart Modem to prevent buffer overruns.

CTS flow control is enabled by default; you can disable it with [D7 \(DIO7/CTS\)](#). When the serial receive buffer fills with the number of bytes specified by [FT \(Flow Control Threshold\)](#), the device de-asserts CTS (sets it high) to signal the host device to stop sending serial data. The device re-asserts CTS when less than FT-32 bytes are in the UART receive buffer.

Note Serial flow control is not possible when using the SPI port.

RTS flow control

If you set [D6 \(DIO6/RTS\)](#) to enable RTS flow control, the device does not send data in the serial transmit buffer out the DOUT pin as long as RTS is de-asserted (set high). Do not de-assert RTS for long periods of time or the serial transmit buffer will fill.

Enable UART or SPI ports

To enable the UART port, configure DIN and DOUT (**P3** and **P4** parameters) as peripherals. To enable the SPI port, enable SPI_MISO, SPI_MOSI, SPI_SSEL, and SPI_CLK (**P5** through **P9**) as peripherals. If you enable both ports then output goes to the UART until the first input on SPI.

When both the UART and SPI ports are enabled on power-up, all serial data goes out the UART. As soon as input occurs on either port, that port is selected as the active port and no input or output is allowed on the other port until the next device reset.

If you change the configuration so that only one port is configured, then that port is the only one enabled or used. If the parameters are written with only one port enabled, then the port that is not enabled is not used even temporarily after the next reset.

If both ports are disabled on reset, the device uses the UART in spite of the wrong configuration so that at least one serial port is operational.

SPI operation

SPI communications	96
Full duplex operation	97
Low power operation	98
Select the SPI port	98
Force UART operation	99
Data format	99

SPI communications

The XBee Smart Modem supports SPI communications in slave mode. Slave mode receives the clock signal and data from the master and returns data to the master. The following table shows the signals that the SPI port uses on the device.

Signal	Function
SPI_MOSI (Master Out, Slave In)	Inputs serial data from the master
SPI_MISO (Master In, Slave Out)	Outputs serial data to the master
SPI_SCLK (Serial Clock)	Clocks data transfers on MOSI and MISO
SPI_SSEL (Slave Select)	Enables serial communication with the slave
SPI_ATT \bar{N} (Attention)	Alerts the master that slave has data queued to send. The XBee Smart Modem asserts this pin as soon as data is available to send to the SPI master and it remains asserted until the SPI master has clocked out all available data.

In this mode:

- SPI clock rates up to 4.8 MHz are possible.
- Data is most significant bit (MSB) first; bit 7 is the first bit of a byte sent over the interface.
- Frame Format mode 0 is used. This means CPOL= 0 (idle clock is low) and CPHA = 0 (data is sampled on the clock's leading edge).
- The SPI port only supports API Mode (**AP = 1**).

The following diagram shows the frame format mode 0 for SPI communications.

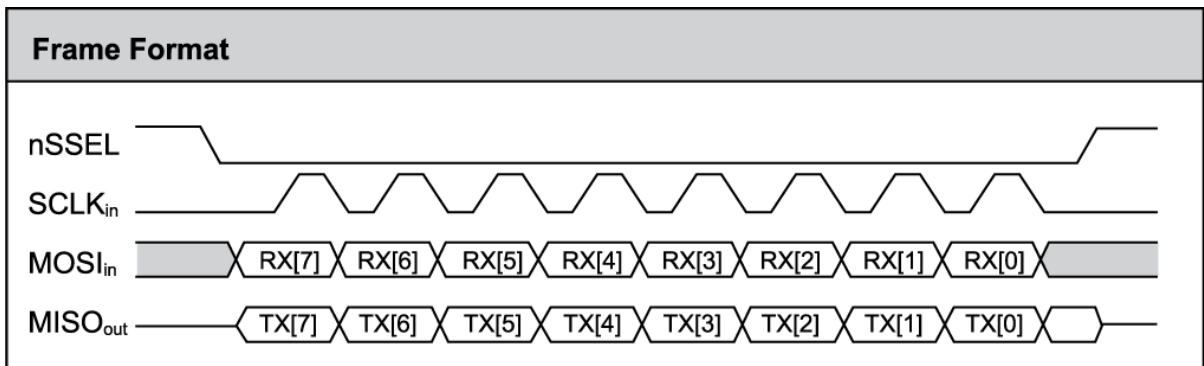

SPI mode is chip to chip communication. We do not supply a SPI communication option on the device development evaluation boards.

Full duplex operation

The specification for SPI includes the four signals SPI_MISO, SPI_MOSI, SPI_CLK, and SPI_SSEL. Using these four signals, the SPI master cannot know when the slave needs to send and the SPI slave cannot transmit unless enabled by the master. For this reason, the SPI_ATTN signal is available in the design. This allows the SPI slave to alert the SPI master that it has data to send. In turn, the SPI master is expected to assert SPI_SSEL and start SPI_CLK, unless these signals are already asserted and active respectively. This, in turn, allows the XBee Smart Modem SPI slave to send data to the master.

SPI data is latched by the master and slave using the SPI_CLK signal. When data is being transferred the MISO and MOSI signals change between each clock. If data is not available then these signals will not change and will be either 0 or 1. This results in receiving either a repetitive 0 or 0xFF. The means of determining whether or not received data is valid is by packetizing the data with API packets, without escaping. Valid data to and from the XBee Smart Modem is delimited by 0x7E, a length, the payload, and finally a checksum byte. Everything else in both directions should be ignored. The bytes received between frames will be either 0xff or 0x00. This allows the SPI master to scan for a 0x7E delimiter between frames.

SPI allows for valid data from the slave to begin before, at the same time, or after valid data begins from the master. When the master is sending data to the slave and the slave has valid data to send in the middle of receiving data from the master, it allows a true full duplex operation where data is valid in both directions for a period of time. During this time, the master and slave must simultaneously transmit valid data at the clock speed so that no invalid bytes appear within an API frame, causing the whole frame to be discarded.

An example follows to more fully illustrate the SPI interface during the time valid data is being sent in both directions. First, the master asserts SPI_SSEL and starts SPI_CLK to send a frame to the slave.

Initially, the slave does not have valid data to send the master. However, while it is still receiving data from the master, it has its own data to send. Therefore, it asserts SPI_ATTN low. Seeing that SPI_SSEL is already asserted and that SPI_CLK is active, it immediately begins sending valid data, even while it is receiving valid data from the master. In this example, the master finishes its valid data before the slave does. The master will have two indications of valid data: The SPI_ATTN line is asserted and the API frame length is not yet expired. For both of these reasons, the master should keep SPI_SSEL asserted and should keep SPI_CLK toggling in order to receive the end of the frame from the slave, even though these signals were originally turned on by the master to send data. During the time that the SPI master is sending invalid data to the SPI slave, it is important no 0x7E is included in that invalid data because that would trigger the SPI slave to start receiving another valid frame.

The following figure illustrates the SPI interface while valid data is being sent in both directions.

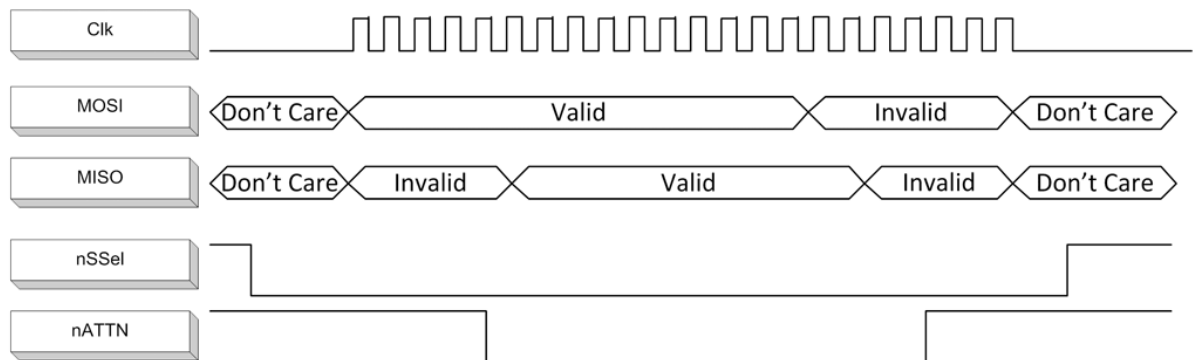

Low power operation

Sleep modes generally work the same on SPI as they do on UART. However, due to the addition of SPI mode, there is an option of another sleep pin, as described below.

By default, Digi configures DIO8 (SLEEP_REQUEST) as a peripheral and during pin sleep it wakes the device and puts it to sleep. This applies to both the UART and SPI serial interfaces.

If SLEEP_REQUEST is not configured as a peripheral and SPI_SSEL is configured as a peripheral, then pin sleep is controlled by SPI_SSEL rather than by SLEEP_REQUEST. Asserting SPI_SSEL (pin 17) by driving it low either wakes the device or keeps it awake. Negating SPI_SSEL by driving it high puts the device to sleep.

Using SPI_SSEL to control sleep and to indicate that the SPI master has selected a particular slave device has the advantage of requiring one less physical pin connection to implement pin sleep on SPI. It has the disadvantage of putting the device to sleep whenever the SPI master negates SPI_SSEL (meaning time is lost waiting for the device to wake), even if that was not the intent.

If the user has full control of SPI_SSEL so that it can control pin sleep, whether or not data needs to be transmitted, then sharing the pin may be a good option in order to make the SLEEP_REQUEST pin available for another purpose.

If the device is one of multiple slaves on the SPI, then the device sleeps while the SPI master talks to the other slave, but this is acceptable in most cases.

If you do not configure either pin as a peripheral, then the device stays awake, being unable to sleep in SM1 mode.

Select the SPI port

- **D1** (This parameter will only be changed if it is at a default of zero when the method is invoked.)
- **D2**
- **D3**
- **D4**
- **P2**

As long as the host does not issue a **WR** command, these configuration values revert to previous values after a power-on reset. If the host issues a **WR** command while in SPI mode, these same parameters are written to flash. After a reset, parameters that were forced and then written to flash become the mode of operation.

If the UART is disabled and the SPI is enabled in the written configuration, then the device comes up in SPI mode without forcing it by holding DOUT low. If both the UART and the SPI are enabled at the time of reset, then output goes to the UART until the host sends the first input. If that first input comes on the SPI port, then all subsequent output goes to the SPI port and the UART is disabled. If the first input comes on the UART, then all subsequent output goes to the UART and the SPI is disabled.

When the master asserts the slave select (SPI_SSEL) signal, SPI transmit data is driven to the output pin SPI_MISO, and SPI data is received from the input pin SPI_MOSI. The SPI_SSEL pin has to be asserted to enable the transmit serializer to drive data to the output signal SPI_MISO. A rising edge on SPI_SSEL causes the SPI_MISO line to be tri-stated such that another slave device can drive it, if so desired.

Force UART operation

If you configure a device with only the SPI enabled and no SPI master is available to access the SPI slave port, you can recover the device to UART operation by holding DIN / CONFIG low at reset time. DIN/CONFIG forces a default configuration on the UART at 9600 baud and brings up the device in Command mode on the UART port. You can then send the appropriate commands to the device to configure it for UART operation. If you write those parameters, the device comes up with the UART enabled on the next reset.

Data format

SPI only operates in API mode 1. The XBee Smart Modem does not support Transparent mode or API mode 2 (which escapes control characters). This means that the AP configuration only applies to the UART, and the device ignores it while using SPI. The reason for this operation choice is that SPI is full duplex. If data flows in one direction, it flows in the other. Since it is not always possible to have valid data flowing in both directions at the same time, the receiver must have a way to parse out the valid data and to ignore the invalid data.

The XBee Smart Modem sends **0xFF** when there is no data to send to the host.

File system

For detailed information about using MicroPython on the XBee Smart Modem refer to the [Digi MicroPython Programming Guide](#).

Overview of the file system	101
XCTU interface	102
Encrypt files	102

Overview of the file system

XBee Smart Modem firmware versions ending in **0B** (for example, 1130B, 100B, 3100B) and later include support for storing files on an internal 1 MB SPI flash.



CAUTION! You need to [format the file system](#) if upgrading a device that originally shipped with older firmware. You can use XCTU, AT commands or MicroPython for that initial format or to erase existing content at any time.

Note To use XCTU with file system, you need XCTU 6.4.0 or newer.

See [ATFS FORMAT confirm](#) and ensure that the format is complete.

Directory structure

The SPI flash appears in the file system as **/flash**, the only entry at the root level of the file system. It has a **lib** directory intended for MicroPython modules and a **cert** directory for files used for SSL/TLS sockets.

Paths

The XBee Smart Modem stores all of its files in the top-level directory **/flash**. On startup, the **ATFS** commands and MicroPython each use that as their current working directory. When specifying the path to a file or directory, it is interpreted as follows:

- Paths starting with a forward slash are "absolute" and must start with **/flash** to be valid.
- All other paths are relative to the current working directory.
- The directory **..** refers to the parent directory, so an operation on **../filename.txt** that takes place in the directory **/flash/test** accesses the file **/flash/filename.txt**.
- The directory **.** refers to the current directory, so the command **ATFS ls .** lists files in the current directory.
- Names are case-insensitive, so **FILE.TXT**, **file.txt** and **File.Txt** all refer to the same file.
- File and directory names are limited to 64 characters, and can only contain letters, numbers, periods, dashes and underscores. A period at the end of the name is ignored.
- The full, absolute path to a file or directory is limited to 255 characters.

Secure files

The file system includes support for secure files with the following properties:

- Created via the **ATFS XPUT** command or in MicroPython using a mode of ***** with the **open()** method.
- Unable to download via the **ATFS GET** command or MicroPython's **open()** method.
- SHA256 hash of file contents available from **ATFS HASH** command (to compare with a local copy of a file).
- Encrypted on the SPI flash.

- MicroPython can execute code in secure files.
- Sockets can use secure files when creating SSL/TLS connections.

XCTU interface

XCTU releases starting with 6.4.0 include a **File System Manager** in the **Tools** menu. You can upload files to and download files from the device, in addition to renaming and deleting existing files and directories. See the [File System manager tool](#) section of the *XCTU User Guide* for details of its functionality.

Encrypt files

You can encrypt files on the file system. This provides two things:

1. Protection of the client private key for SSL authentication while it is stored on the XBee Smart Modem.
2. Protection for user's MicroPython applications.

Use [ATFS XPUT filename](#) to place encrypted files on the file system. The XPUT operation is otherwise identical to the PUT operation. Files placed in this way are indicated with a **pound sign (#)** following the filename. The XBee Smart Modem does not allow an encrypted file to be read by normal use so it:

1. Cannot be retrieved with the GET operation.
2. Cannot be opened and read in MicroPython applications.
3. Cannot be created by a MicroPython application.

When [ATFS HASH filename](#) is run with the filename of an encrypted file, it reports the SHA256 hash of the file contents. In this way you can validate that the correct file has been placed on the XBee Smart Modem.

Socket behavior

Supported sockets	104
Socket timeouts	104
Socket limits in API mode	104
Enable incoming TCP connections	104
API mode behavior for outgoing TCP and SSL connections	105
API mode behavior for outgoing UDP data	105
API mode behavior for incoming TCP connections	105
API mode behavior for incoming UDP data	106
Transparent mode behavior for outgoing TCP and SSL connections	106
Transparent mode behavior for outgoing UDP data	107
Transparent mode behavior for incoming TCP connections	107
Transparent mode behavior for incoming UDP connections	107

Supported sockets

The XBee Smart Modem supports the following number of sockets:

- 10 maximum: some combination of 6 TCP, 6 UDP, 6 SSL.¹

Socket timeouts

The XBee Smart Modem implicitly opens the socket any time there is data to be sent, and closes it according to the timeout settings. The [TM \(IP Client Connection Timeout\)](#) command controls the timeout settings.

Socket limits in API mode

There are a fixed number of sockets that can be created which varies by device variant and protocol.

When a [Transmit \(TX\) Request: IPv4 - 0x20](#) frame is sent to the XBee Smart Modem for a new destination, it creates a new socket. The exception to this is when using the UDP protocol with the **C0** source port, which allows unlimited destinations on the socket created by [C0 \(Source Port\)](#).

If no more sockets are available, the device sends back a [Transmit \(TX\) Status - 0x89](#) frame with a Resource Error.

The Resource Error resolves when an existing socket is closed.

An existing socket may be closed when the socket times out (see [TM \(IP Client Connection Timeout\)](#) and [TS \(IP Server Connection Timeout\)](#)) or when the socket is closed via a TX request with the CLOSE flag set.

Enable incoming TCP connections

TCP establishes virtual connections between the XBee Smart Modem and other devices. You can enable the XBee Smart Modem to listen for incoming TCP connections. Listen means waiting for a connection request from any remote TCP and port.²

The following devices support incoming TCP connections:

- Part number: XBC-V1-UT-001 (Digi XBee Cellular Verizon LTE Cat 1)
- Part number: XBC-M1-UT-001 (Digi XBee Cellular AT&T LTE Cat 1)
- Part number: XB3-C-A1-UT-xxx (Digi XBee3 Cellular AT&T LTE Cat 1)

The XBee Smart Modem only supports incoming TCP and UDP connections as configured in [IP \(IP Protocol\)](#), SSL is not supported.

To enable incoming connections in XCTU:

1. Set [AP \(API Enable\)](#) to **Transparent Mode [0]** or **API Mode**. You can use either API mode with escapes or without escapes.
2. Set **IP to TCP [1]** or **UDP [0]**.
3. Set [C0 \(Source Port\)](#) to the value of the TCP port that the device listens on.
4. Click the **Write** button .

¹ UDP socket is always reserved for DNS, so subtract 1 socket from the values above.

²See <https://tools.ietf.org/html/rfc793>.

API mode behavior for outgoing TCP and SSL connections

To initiate an outgoing TCP or SSL connection to a remote host, send a [Transmit \(TX\) Request: IPv4 - 0x20](#) frame to the XBee Smart Modem's serial port specifying the destination address and destination port for the remote host; the data is optional and the source port is **0**.

If the connection is disconnected at any time, send a Transmit TX Request frame to trigger a new connection attempt.

To send data over this connection use the [Transmit \(TX\) Request: IPv4 - 0x20](#).

The device sends a [Transmit \(TX\) Status - 0x89](#) frame in reply to the Transmit TX Request indicating the status of the request. A status of **0** indicates the connection and/or data was successful and a non-zero value indicates a failure.

Any data received on the connection is sent out the XBee Smart Modem's serial port as a Receive RX frame.

A connection is closed when:

- The remote end closes the connection.
- No data is sent or received for longer than the socket timeout set by [TM \(IP Client Connection Timeout\)](#).
- A Transmit TX Request is sent with the CLOSE flag set.

API mode behavior for outgoing UDP data

To send a UDP datagram to a remote host, send a [Transmit \(TX\) Request: IPv4 - 0x20](#) frame to the XBee Smart Modem's serial port specifying the destination address and destination port of the remote host. If you use a source port of **0**, the device creates a new socket for the purpose of sending to the remote host. The XBee Smart Modem supports a finite number of sockets, so if you need to send to many destinations:

1. The socket must be closed after use.
- or
2. You must use the socket specified by the [C0 \(Source Port\)](#) setting.

To use the socket specified by the **C0** setting, in the Transmit TX request frame use a source port that matches the value configured for the **C0** setting.

The device sends a [Transmit \(TX\) Status - 0x89](#) frame in reply to the Transmit TX Request to indicate the status of the request. A status of **0** indicates the data was successfully sent out of the device and a non-zero value indicates a failure.

Any data received on the UDP socket is sent out the XBee Smart Modem's serial port as a [Receive \(RX\) Packet: IPv4 - 0xB0](#) frame.

A UDP socket is closed when:

- No data has been sent or received for longer than the socket timeout set by [TM \(IP Client Connection Timeout\)](#).
- A transmit TX Request is sent with the CLOSE flag set.

API mode behavior for incoming TCP connections

For incoming connections and data in API mode, the XBee Smart Modem uses the [C0 \(Source Port\)](#) and [IP \(IP Protocol\)](#) settings to specify the listening port and protocol used. The XBee Smart Modem does not currently support the SSL protocol for incoming connections.

When the **IP** setting is TCP the XBee Smart Modem allows multiple incoming TCP connections on the port specified by the **C0** setting. Any data received on the connection is sent out the XBee Smart Modem's serial port as a [Receive \(RX\) Packet: IPv4 - 0xB0](#) frame.

To send data from the device over the connection, use the [Transmit \(TX\) Request: IPv4 - 0x20](#) frame with the corresponding address fields received from the Receive RX frame. In other words:

- Take the source address, source port, and destination port fields from the Receive (RX) frame and use those respectively as:
- The destination address, destination port, and source port fields for the Transmit (TX) Request frame.

A connection is closed when:

- The remote end closes the connection.
- No data has been sent or received for longer than the socket timeout set by [TS \(IP Server Connection Timeout\)](#).
- A Transmit (TX) Request frame is sent with the CLOSE flag set.

API mode behavior for incoming UDP data

When the **IP (IP Protocol)** setting is UDP, any data sent from a remote host to the XBee Smart Modem's network port specified by the **C0 (Source Port)** setting is sent out the XBee Smart Modem's serial port as a [Receive \(RX\) Packet: IPv4 - 0xB0](#) frame.

To send data from the XBee Smart Modem to the remote destination, use the [Transmit \(TX\) Request: IPv4 - 0x20](#) frame with the corresponding address fields received from the Receive RX frame. In other words take the source address, source port, and destination port fields from the Receive (RX) frame and use those respectively as the destination address, destination port, and source port fields for the Transmit (TX) Request frame.

Transparent mode behavior for outgoing TCP and SSL connections

For Transparent mode, the **IP (IP Protocol)** setting specifies the protocol and the **DL (Destination Address)** and **DE (Destination Port)** settings specify the destination address used for outgoing data (UDP) and outgoing connections (TCP and SSL).

To initiate an outgoing TCP or SSL connection to a remote host, send data to the XBee Smart Modem's serial port. If **CI (Protocol/Connection Indication)** reports a value of **0**, then the connection was successfully established, otherwise the value of **CI** indicates why the connection attempt failed. Any data received over the connection is sent out the XBee Smart Modem's serial port.

A connection is closed when:

- The remote end closes the connection.
- No data has been sent or received for longer than the socket timeout set by [TM \(IP Client Connection Timeout\)](#).
- You make and apply a change to the **IP**, **DL**, or **DE**.

Transparent mode behavior for outgoing UDP data

To send outgoing UDP data to a remote host, send data to the XBee Smart Modem's serial port. If **CI** ([Protocol/Connection Indication](#)) reports a value of **0**, the data was successfully sent; otherwise, the value of **CI** indicates why the data failed to be sent.

The **RO** ([Packetization Timeout](#)) setting provides some control in how the serial data gets packetized before being sent to the remote host. The first send opens up a UDP socket used to send and receive data. Any data received by this socket is sent out the XBee Smart Modem's serial port.

Note Set **RO** to **FF** for realtime typing by humans. Also, see [TD \(Text Delimiter\)](#).

Transparent mode behavior for incoming TCP connections

The **C0** ([Source Port](#)) and **IP** ([IP Protocol](#)) settings specify the listening port and protocol used for incoming connections (TCP) and incoming data (UDP) in Transparent mode. SSL is not currently supported for incoming connections.

When the **IP** setting is TCP and there is no existing connection to or from the XBee Smart Modem, the device accepts one incoming connection. Any data received on the connection is sent out the XBee Smart Modem's serial port. Any data sent to the XBee Smart Modem's serial port is sent over the connection. If the connection is disconnected, it discards pending data.

Transparent mode behavior for incoming UDP connections

When the **IP** ([IP Protocol](#)) setting is UDP any data sent from a remote host to the XBee Smart Modem's network port specified by **C0** ([Source Port](#)) is sent out the XBee Smart Modem's serial port. Any data sent to the XBee Smart Modem's serial port is sent to the network destination specified by the **DL** ([Destination Address](#)) and **DE** ([Destination Port](#)) settings. If the **DL** and **DE** settings are unspecified or invalid, the XBee Smart Modem discards data sent to the serial port.

Transport Layer Security (TLS)

For detailed information about using MicroPython on the XBee Smart Modem refer to the [Digi MicroPython Programming Guide](#).

TLS AT commands	109
Transparent mode and TLS	110
API mode and TLS	110
Key formats	110
Certificate formats	110
Certificate limitations	110
Cipher suites	110
Server Name Indication (SNI)	111

TLS AT commands

The AT commands [ATFS \(File System\)](#), [TL \(SSL/TLS Protocol Version\)](#), [IP \(IP Protocol\)](#), [\\$0 \(SSL/TLS Profile 0\)](#), [\\$1 \(SSL/TLS Profile 1\)](#), and [\\$2 \(SSL/TLS Profile 2\)](#) support TLS. The format of the \$ commands is:

AT\$<num>[<ca_cert>];[<client_cert>];[<client_key>]

Where:

- **num**: Profile index. Index zero is used for Transparent mode connections and TLS connections using [Transmit \(TX\) Request: IPv4 - 0x20](#).
- **ca_cert**: (optional) Filename of a file in the **certs/** directory. Indicates the certificate identifying a trusted root certificate authority (CA) to use in validating servers. If **ca_cert** is empty the server certificate is not authenticated. This must be a single root CA certificate. The modules do not allow a non-self signed certificate to work, so intermediate CAs are not enough.
- **client_cert**: (optional) Filename of a file in the **certs/** directory. Indicates the certificate presented to servers when requested for client authentication. If **client_cert** is empty no certificate is presented to the server should it request one. This may result in mutual authentication failure.
- **client_key**: (optional) Filename of a file in the **certs/** directory. Indicates the private key matching the public key contained in **client_cert**. This should be a secure file uploaded with [ATFS XPUT filename](#). This should always be provided if **client_cert** is provided and match the certificate or client authentication will fail.

The default value is ";;". This default value preserves the legacy behavior by allowing the creation of encrypted connections that are confidential but not authenticated.

To specify a key stored outside of **certs/**, you can either use a relative path, for example **../server.pem** or an absolute path starting with **/flash**, for example **/flash/server.pem**. Both examples refer to the same file.

It is not an error at configuration time to name a file that does not yet exist. An error is generated if an attempt to create a TLS connection is made with improper settings.

- Files specified should all be in PEM format, not DER.
- Upload private keys securely with [ATFS XPUT filename](#).
- Certificates can be uploaded with [ATFS PUT filename](#) as they are not sensitive. It is not possible to use [ATFS GET filename](#) to **GET** them if they have been securely uploaded.

To authenticate a server not participating in a public key infrastructure (PKI) using CAs, the server must present a self-signed certificate. That certificate can be used in the **ca_cert** field to authenticate that single server.

There are effectively three levels of authentication provided depending on the parameters provided

1. No authentication: None of the parameters are provided, this is the default value. With this configuration identity is not validated and a man in the middle (MITM) attack is possible.
2. Server authentication: Only **ca_cert** is provided. Only the servers identity is checked
3. Mutual authentication: All items are provided and both sides are assured of the identity of their peer

It is not possible to only have client authentication.

Transparent mode and TLS

Transparent mode connections made when **IP (IP Protocol) = 4** (TLS) are made using the configuration specified by **\$0 (SSL/TLS Profile 0)**.

API mode and TLS

On the **Transmit (TX) Request: IPv4 - 0x20** frame, when you specify protocol **4** (TLS), the profile configuration specified by **\$0 (SSL/TLS Profile 0)** is used to form the TLS connection. **Tx Request with TLS Profile - 0x23** lets you choose the IP setting for the serial data.

Key formats

The RSA PKCS#1 format is the only common format across XBee Cellular device variants. You can identify a PKCS#1 key file by the presence of **BEGIN RSA PRIVATE KEY** in the file header.

Digi's implementation does not support encrypted keys, we use file system encryption to protect the keys at rest in the system.

Certificate formats

The XBee3 Cellular LTE-M Global Smart Modem and the XBee Cellular 3G Global Embedded Modem do not support X509 v3 certificates and extensions for the client certificate. However, v3 certificates are fine for CA certificates used in server authentication.

Certificate limitations

The XBee Smart Modem only supports certificate files that contain a single certificate in them. The implications of this are:

- For client certificate files (for example when client authentication is required):
 - Self-signed certificates will work.
 - Certificates signed by the root CA will work, because the root CA can be omitted per RFC 5246. The root certificate authority may be omitted from the chain, under the assumption that the remote end must already possess it in order to validate it in any case.
 - Certificate chains that include an intermediate CA are problematic. To work around this the client's certificate chain has to be supplied to the server outside of the connection.
- For server certificate files (when server authentication is required) this is not a problem unless the client is expected to connect to multiple servers that are using different self signed certificates or are using certificate chains that are signed by different root CA certificates. To work around this you have to change the certificates before making the connection, or in the case of API mode specify a different authentication profile.

Cipher suites

The only documented shared suites between the XBee3 Cellular LTE Cat 1 Smart Modem and the XBee3 Cellular LTE-M Global Smart Modem are:

- TLS_RSA_WITH_AES_128_CBC_SHA
 - TLS_RSA_WITH_AES_256_CBC_SHA
- For the Telit LE866 cellular component:
- TLS_RSA_WITH_RC4_128_MD5
 - TLS_RSA_WITH_RC4_128_SHA
 - TLS_RSA_WITH_AES_128_CBC_SHA
 - TLS_RSA_WITH_NULL_SHA
 - TLS_RSA_WITH_AES_256_CBC_SHA

This list may be incomplete.

Server Name Indication (SNI)

We do not currently support SNI. Therefore servers which use SNI to present certificates based on client provided host data may be unable to establish the expected connections.

AT commands

Special commands	113
Cellular commands	114
Network commands	117
Addressing commands	120
Serial interfacing commands	123
I/O settings commands	125
I/O sampling commands	133
Sleep commands	135
Command mode options	136
MicroPython commands	137
Firmware version/information commands	138
Diagnostic interface commands	140
Execution commands	143
File system commands	143

Special commands

The following commands are special commands.

AC (Apply Changes)

Immediately applies new settings without exiting Command mode.

Applying changes means that the device re-initializes based on changes made to its parameter values. Once changes are applied, the device immediately operates according to the new parameter values.

This behavior is in contrast to issuing the **WR** (Write) command. The **WR** command saves parameter values to non-volatile memory, but the device still operates according to previously saved values until the device is rebooted or you issue the **CN** (Exit AT Command Mode) or **AC** commands.

Parameter range

N/A

Default

N/A

FR (Force Reset)

Resets the device. The device responds immediately with an **OK** and performs a reset 100 ms later.

If you issue **FR** while the device is in Command Mode, the reset effectively exits Command mode.

Note We recommend entering Airplane mode before resetting or rebooting the device to allow the cellular module to detach from the network.

Parameter range

N/A

Default

N/A

RE command

Restore device parameters to factory defaults.

The **RE** command does not write restored values to non-volatile (persistent) memory. Issue the **WR** (Write) command after issuing the **RE** command to save restored parameter values to non-volatile memory.

Parameter range

N/A

Default

N/A

WR (Write)

Writes parameter values to non-volatile memory so that parameter modifications persist through subsequent resets.

Note Once you issue a **WR** command, do not send any additional characters to the device until after you receive the **OK** response.

Parameter range

N/A

Default

N/A

Cellular commands

The following AT commands are cellular configuration and data commands.

PH (Phone Number)

Reads the SIM card phone number.

If **PH** is blank, the XBee Smart Modem is not registered to the network.

Parameter range

N/A

Default

Set by the cellular carrier via the SIM card

S# (ICCID)

Reads the Integrated Circuit Card Identifier (ICCID) of the inserted SIM.

Parameter range

N/A

Default

Set by the SIM card

IM (IMEI)

Reads the device's International Mobile Equipment Identity (IMEI).

Parameter range

N/A

Default

Set in the factory

MN (Operator)

Reads the network operator on which the device is registered.

Parameter range

N/A

Default

AT&T

MV (Modem Firmware Version)

Read the firmware version string for cellular component communications. See the related [VR \(Firmware Version\)](#) command.

Parameter range

N/A

Default

Set in the currently loaded firmware

DB (Cellular Signal Strength)

Reads the absolute value of the current signal strength to the cell tower in dB. If **DB** is blank, the XBee Smart Modem has not received a signal strength from the cellular component.

Parameter range

0x71 - 0x33 (-113 dBm to -51 dBm) [read-only]

Default

N/A

AN (Access Point Name)

Specifies the packet data network that the modem uses for Internet connectivity. This information is provided by your cellular network operator. After you set this value, applying changes with [AC \(Apply Changes\)](#) or [CN \(Exit Command mode\)](#) triggers a network reset.

Parameter range

1 - 100 ASCII characters

Default

-

CP (Carrier Profile)

Configures the cellular component to select network operator settings (RF bands, packet data configuration) for various networks.

The default setting of **0** (autodetect) increases the boot time.

Changes to the value only take effect on boot so a reboot or power cycle is required for any changes to become active.

Parameter range

0 - 3

Value	Description
0	Autodetect from inserted ICCID (SIM) [default]
1	Reserved
2	AT&T
3	Verizon

Default

0

OA (Operating APN)

Reads the APN value currently configured in the cellular component.

Parameter range

ASCII characters

Default

N/A

AM (Airplane Mode)

When set, the cellular component of the XBee Smart Modem is fully turned off and no access to the cellular network is performed or possible.

Parameter range

0 - 1

0 = Normal operation

1 = Airplane mode

Default

0

DV (Antenna Diversity)

Set and read the antenna diversity setting of the cellular component. When enabled, the cellular component uses both antennas to improve receive sensitivity.

This setting is applied only while the XBee Smart Modem is initializing the cellular component. After changing this setting, you must:

1. Use [WR \(Write\)](#) to write all values to flash.
2. Use [FR \(Force Reset\)](#) to reset the device.
3. Wait for the cellular component to be initialized: [AI \(Association Indication\)](#) reaches **0x00**.
4. Use **FR** to reset the device a second time.
5. Wait again for the cellular component to initialize: **AI** reaches **0x00**.

Parameter range

- 0 - 1
- 0 - diversity disabled
- 1 - diversity enabled

Default

1

Network commands

The following commands are network commands.

IP (IP Protocol)

Sets or displays the IP protocol used for client and server socket connections in IP socket mode.

Parameter range

0 - 4

Value	Description
0x00	UDP
0x01	TCP
0x02	SMS
0x03	Reserved
0x04	SSL over TCP communication

Default

0x01

TL (SSL/TLS Protocol Version)

Sets the SSL/TLS protocol version used for the SSL socket. If you change the **TL** value, it does not affect any currently open sockets. The value only applies to subsequently opened sockets.

Note Due to known vulnerabilities in prior protocol versions, we strongly recommend that you use the latest TLS version whenever possible.

Range

Value	Description
0x00	SSL v3
0x01	TLS v1.0

Value	Description
0x02	TLS v1.1
0x03	TLS v1.2

Default

0x03

\$0 (SSL/TLS Profile 0)

Specifies the SSL/TLS certificate(s) to use in Transparent mode (when IP (IP Protocol) = 4) or API mode (Transmit (TX) Request: IPv4 - 0x20 or Tx Request with TLS Profile - 0x23 with profile set to 0).

Format

server_cert;client_cert;client_key

Parameter range

From 1 through 127 ASCII characters.

Default

N/A

\$1 (SSL/TLS Profile 1)

Specifies the SSL/TLS certificate(s) to use for Tx Request with TLS Profile - 0x23 transmissions with profile set to 1.

Format

server_cert;client_cert;client_key

Parameter range

From 1 through 127 ASCII characters.

Default

N/A

\$2 (SSL/TLS Profile 2)

Specifies the SSL/TLS certificate(s) to use in Transparent mode (when IP (IP Protocol) = 4) or API mode (Transmit (TX) Request: IPv4 - 0x20 or Tx Request with TLS Profile - 0x23 with profile set to 0).

Format

server_cert;client_cert;client_key

Parameter range

From 1 through 127 ASCII characters.

Default

N/A

TM (IP Client Connection Timeout)

The IP client connection timeout. If there is no activity for this timeout then the connection is closed. If **TM** is **0**, the connection is closed immediately after the device sends data.

If you change the **TM** value while in Transparent Mode, the current connection is immediately closed. Upon the next transmission, the **TM** value applies to the newly created socket.

If you change the **TM** value while in API Mode, the value only applies to subsequently opened sockets.

Parameter range

0 - 0xFFFF [x 100 ms]

Default

0xBB8 (5 minutes)

TS (IP Server Connection Timeout)

The IP server connection timeout. If no activity for this timeout then the connection is closed. When set to **0** the connection is closed immediately after data is sent.]

Parameter Range

10 - 0xFFFF; (x 100 ms)

Default

3000

DO (Device Options)

Enables and disables special features on the XBee Smart Modem.

Bit 0 - Remote Manager support

If the XBee Smart Modem cannot establish a connection with Remote Manager, it waits 30 seconds before trying again. On each successive connection failure, the wait time doubles (60 seconds, 120, 240, and so on) up to a maximum of 1 hour. This time resets to 30 seconds once the connection to Remote Manager succeeds or if the device is reset.

Bits 1 - 7

Reserved

Range

0x00 - 0x07

Bitfield

Bit	Description
0x00	Disable Remote Manager support
0x01	Enable Remote Manager support

Default

0x01

EQ (Remote Manager FQDN)

Sets or display the fully qualified domain name of the Remote Manager server.

Range

From 0 through 63 ASCII characters.

Default

my.devicecloud.com

Addressing commands

The following AT commands are addressing commands.

SH (Serial Number High)

The upper digits of the unique International Mobile Equipment Identity (IMEI) assigned to this device.

Parameter range

0 - 0xFFFFFFFF [read-only]

Default

N/A

SL (Serial Number Low)

The lower digits of the unique International Mobile Equipment Identity (IMEI) assigned to this device.

Parameter range

0 - 0xFFFFFFFF [read-only]

Default

N/A

MY (Module IP Address)

Reads the device's IP address. This command is read-only because the IP address is assigned by the mobile network.

In API mode, the address is represented as the binary four byte big-endian numeric value representing the IPv4 address.

In Transparent or Command mode, the address is represented as a dotted-quad string notation.

Parameter range

0- 15 IPv4 characters

Default

0.0.0.0

P# (Destination Phone Number)

Sets or displays the destination phone number used for SMS when IP (IP Protocol) = 2. Phone numbers must be fully numeric, 7 to 20 ASCII digits, for example: 8889991234.

P# allows international numbers with or without the + prefix. If you omit + and are dialing internationally, you need to include the proper International Dialing Prefix for your calling region, for example, 011 for the United States.

Range

7 - 20 ASCII digits including an optional + prefix

Default

N/A

N1 (DNS Address)

Displays the IPv4 address of the primary domain name server.

Parameter Range

Read-only

Default

0.0.0.0 (waiting on cellular connection)

N2 (DNS Address)

Displays the IPv4 address of the secondary domain name server.

Parameter Range

Read-only

Default

0.0.0.0 (waiting on cellular connection)

DL (Destination Address)

The destination IPv4 address or fully qualified domain name.

To set the destination address to an IP address, the value must be a dotted quad, for example **XXX.XXX.XXX.XXX**.

To set the destination address to a domain name, the value must be a legal Internet host name, for example **remotemanager.digi.com**

Parameter range

0 - 128 ASCII characters

Default

0.0.0.0

OD (Operating Destination Address)

Read the destination IPv4 address currently in use by Transparent mode. The value is **0.0.0.0** if no Transparent IP connection is active.

In API mode, the address is represented as the binary four byte big-endian numeric value representing the IPv4 address.

In Transparent or Command mode, the address is represented as a dotted-quad string notation.

Parameter range

-

Default

0.0.0.0

DE (Destination Port)

Sets or displays the destination IP port number.

Parameter range

0x0 - 0xFFFF

Default

0x2616

C0 (Source Port)

Set or get the port number used to provide the serial communication service. Data received by this port on the network is transmitted on the XBee Smart Modem's serial port.

As long as a network connection is established to this port (for TCP) data received on the serial port is transmitted on the established network connection.

[IP \(IP Protocol\)](#) sets the protocol used when UART is in Transparent or API mode.

For more information on using incoming connections, see [Socket behavior](#).

Parameter range

0 - 0xFFFF

Value	Description
0	Disabled
Non-0	Enabled on that port

Default

0

LA (Lookup IP Address of FQDN)

Performs a DNS lookup of the given fully qualified domain name (FQDN) and outputs its IP address.

When you issue the command in API mode, the IP address is formatted in binary four byte big-endian numeric value. In all other cases (for example, Command mode) the format is dotted decimal notation.

Range

Valid FQDN

Default

-

Serial interfacing commands

The following AT commands are serial interfacing commands.

BD (Baud Rate)

Sets or displays the serial interface baud rate for communication between the device's serial port and the host.

Modified interface baud rates do not take effect until the XBee Smart Modem exits Command mode or you issue [AC \(Apply Changes\)](#). The baud rate resets to default unless you save it with [WR \(Write\)](#) or by clicking the **Write module settings** button in XCTU.

Parameter range

Standard baud rates: 0x1 - 0x8

Non-standard baud rates: 0x5B9 to 0x3D090 (250,000 b/s)

Parameter	Description
0x0	1200 b/s
0x1	2400 b/s
0x2	4800 b/s
0x3	9600 b/s
0x4	19200 b/s
0x5	38400 b/s
0x6	57600 b/s
0x7	115200 b/s
0x8	230400 b/s

Default

0x3 (9600 b/s)

NB (Parity)

Set or read the serial parity settings for UART communications.

Parameter range

0x00 - 0x02

Parameter	Description
0x00	No parity
0x01	Even parity
0x02	Odd parity

Default

0x00

SB (Stop Bits)

Sets or displays the number of stop bits for UART communications.

Parameter range

0 - 1

Parameter	Configuration
0	One stop bit
1	Two stop bits

Default

0

RO (Packetization Timeout)

Set or read the number of character times of inter-character silence required before transmission begins when operating in Transparent mode.

RF transmission also starts after 100 bytes (maximum packet size) are received in the **DI** buffer.

Set **RO** to **0** to transmit characters as they arrive instead of buffering them into one RF packet.

Parameter range

0 - 0xFF (x character times)

Default

3

TD (Text Delimiter)

The ASCII character used as a text delimiter for Transparent mode. When you select a character, information received over the serial port in Transparent mode is not transmitted until that character is received. To use a carriage return, set to **0xD**. Set to zero to disable text delimiter checking.

Parameter range

0 - 0xFF

Default

0x0

FT (Flow Control Threshold)

Set or display the flow control threshold.

The device de-asserts CTS when **FT** bytes are in the UART receive buffer.

Parameter range

0x9D - 0x82D

Default

0x681

AP (API Enable)

The API mode setting. The device can format the RF packets it receives into API frames and send them out the UART. When API is enabled the UART data must be formatted as API frames because Transparent mode is disabled. See [Modes](#) for more information.

Parameter range

0x00 - 0x05

Parameter	Description
0x00	API disabled (operate in Transparent mode)
0x01	API enabled
0x02	API enabled (with escaped control characters)
0x03	N/A
0x04	MicroPython REPL
0x05	Bypass mode

Default

0

I/O settings commands

The following AT commands are I/O settings commands.

DO (DIO0/AD0)

Sets or displays the DIO0/AD0 configuration (pin 20).

Parameter range

0, 2 - 5

Parameter	Description
0	Disabled
1	N/A
2	Analog input
3	Digital input
4	Digital output, default low
5	Digital output, default high

Default

0

D1 (DIO1/AD1)

Sets or displays the DIO1/AD1 configuration (pin 19).

Parameter range

0 - 6

Parameter	Description
0	Disabled
1	SPI_ <u>ATTN</u>
2	ADC
3	Digital input
4	Digital output, low
5	Digital output, high
6	I2C SCL

Default

0

D2 (DIO2/AD2)

Sets or displays the DIO2/AD2 configuration (pin 18).

Parameter range

0 - 5

	Description
0	Disabled

	Description
1	SPI_CLK
2	Analog input
3	Digital input
4	Digital output, default low
5	Digital output, default high

Default

0

D3 (DIO3/AD3)

Sets or displays the DIO3/AD3 configuration (pin 17).

Parameter range

0 - 5

Parameter	Description
0	Disabled
1	SPI_SSEL
2	Analog input
3	Digital input
4	Digital output, default low
5	Digital output, default high

Default

0

D4 (DIO4)

Sets or displays the DIO4 configuration (pin 11).

Parameter range

0, 1, 3 - 5

Parameter	Description
0	Disabled
1	SPI_MOSI
2	N/A

Parameter	Description
3	Digital input
4	Digital output, default low
5	Digital output, default high

Default

0

D5 (DIO5/ASSOCIATED_INDICATOR)

Sets or displays the DIO5/ASSOCIATED_INDICATOR configuration (pin 15).

Parameter range

0, 1, 3 - 5

Parameter	Description
0	Disabled
1	Associated LED
2	N/A
3	Digital input
4	Digital output, default low
5	Digital output, default high

Default

1

D6 (DIO6/RTS)Sets or displays the DIO6/ $\overline{\text{RTS}}$ configuration (pin 16).**Parameter range**

0, 1, 3 - 5

Parameter	Description
0	Disabled
1	$\overline{\text{RTS}}$ flow control
2	N/A
3	Digital input
4	Digital output, default low
5	Digital output, default high

Default

0

D7 (DIO7/CTS)Sets or displays the DIO7/ $\overline{\text{CTS}}$ configuration (pin 12).**Parameter range**

0, 1, 3 - 5

Parameter	Description
0	Disabled
1	$\overline{\text{CTS}}$ flow control
2	N/A
3	Digital input
4	Digital output, default low
5	Digital output, default high

Default

0x1

D8 (DIO8/SLEEP_REQUEST)Sets or displays the DIO8/ $\overline{\text{DTR}}$ /SLP_RQ configuration (pin 9).**Parameter range**

0, 1, 3 - 5

Parameter	Description
0	Disabled
1	SLEEP_REQUEST input
3	Digital input
4	Digital output, default low
5	Digital output, default high

Default

1

Sets or displays the DIO9/ $\overline{\text{ON_SLEEP}}$ configuration (pin 13).**Parameter range**

0, 1, 3 - 5

Parameter	Description
0	Disabled
1	ON/ $\overline{\text{SLEEP}}$ output
3	Digital input
4	Digital output, default low
5	Digital output, default high

Default

1

P0 (DIO10/PWM0 Configuration)

Sets or displays the PWM/DIO10 configuration (pin 6).

This command enables the option of translating incoming data to a PWM so that the output can be translated back into analog form.

Parameter range

0 - 5

Parameter	Description
0	Disabled
1	RSSI PWM0 output
2	PWM0 output
3	Digital input
4	Digital output, low
5	Digital output, high

Default

0

P1 (DIO11/PWM1 Configuration)

Sets or displays the DIO11 configuration (pin 7).

Parameter range

0, 1, 3 - 6

Parameter	Description
0	Disabled

Parameter	Description
1	Fan enable. Output is low when the XBee Smart Modem is sleeping, turning an attached fan off when the cellular component is in a power saving mode, and also during Airplane Mode
3	Digital input
4	Digital output, default low
5	Digital output, default high
6	I2C SDA
7	USB direct

Default

0

P2 (DIO12 Configuration)

Sets or displays the DIO12 configuration (pin 4).

Parameter range

0, 1, 3 - 5

Parameter	Description
0	Disabled
1	SPI_MISO
2	N/A
3	Digital input
4	Digital output, default low
5	Digital output, default high

Default

0

P3 (DIO13/DOUT)

Sets or displays the DIO13/DOUT configuration (pin 17).

Parameter range

0, 1

Parameter	Description
0	Disabled
1	UART DOUT enabled

Default

1

P4 (DIO14/DIN)

Sets or displays the DIO14/DIN configuration (pin 3).

Parameter range

0 - 1

Parameter	Description
0	Disabled
1	UART DIN enabled

Default

1

PD (Pull Direction)

The resistor pull direction bit field (**1** = pull-up, **0** = pull-down) for corresponding I/O lines that are set by [PR \(Pull-up/down Resistor Enable\)](#).

If the bit is not set in **PR**, the device uses **PD**.

Note Resistors are not applied to disabled lines.

See [PR \(Pull-up/down Resistor Enable\)](#) for bit mappings, which are the same.

Parameter range

0x0 – 0x7FFF

Default

0 – 0x7FFF

PR (Pull-up/down Resistor Enable)

Sets or displays the bit field that configures the internal resistor status for the digital input lines. Internal pull-up/down resistors are not available for digital output pins, analog input pins, or for disabled pins.

Use the **PD** command to specify whether the resistor is pull-up or pull-down.

- If you set a **PR** bit to 1, it enables the pull-up/down resistor.
- If you set a **PR** bit to 0, it specifies no internal pull-up/down resistor.

The following table defines the bit-field map for both the **PR** and **PD** commands.

Bit	I/O line	Module pin
0	DIO4	pin 11

Bit	I/O line	Module pin
1	DIO3/AD3	pin 17
2	DIO2/AD2	pin 18
3	DIO1/AD1	pin 19
4	DIO0/AD0	pin 20
5	DIO6/ $\overline{\text{RTS}}$	pin 16
6	DIO8/SLEEP_REQUEST	pin 9
7	DIO14/DIN	pin 3
8	DIO5/ASSOCIATE	pin 15
9	DIO9/On/ $\overline{\text{SLEEP}}$	pin 13
10	DIO12	pin 4
11	DIO10	pin 6
12	DIO11	pin 7
13	DIO7/ $\overline{\text{CTS}}$	pin 12
14	DIO13/DOUT	pin 17

Parameter range

0 - 0x7FFF (bit field)

Default

0x7FFF

M0 (PWM0 Duty Cycle)

Sets the duty cycle of PWM0 (pin 6) for **P0 = 2**, where a value of 0x200 is a 50% duty cycle.

Before setting the line as an output:

1. Enable PWM0 output (**P0 (DIO10/PWM0 Configuration) = 2**).
2. Apply the settings (use **CN (Exit Command mode)** or **AC (Apply Changes)**).

The PWM period is 42.62 μs and there are 0x03FF (1023 decimal) steps within this period. When **M0 = 0** (0% PWM), **0x01FF** (50% PWM), **0x03FF** (100% PWM), and so forth.

Parameter range

0 - 0x3FF

Default

0

I/O sampling commands

The following AT commands configure I/O sampling parameters.

TP (Temperature)

Displays the temperature of the XBee Smart Modem in degrees Celsius. The temperature value is displayed in 8-bit two's complement format. For example, **0x1A** = 26 °C, and **0xF6** = -10 °C.

Parameter range

0 - 0xFF which indicates degrees Celsius displayed in 8-bit two's complement format.

Default

N/A

IS (Force Sample)

When run, **IS** reports the values of all of the enabled digital and analog input lines. If no lines are enabled for digital or analog input, the command returns an error.

Command mode

In Command mode, the response value is a multi-line format, individual lines are delimited with carriage returns, and the entire response terminates with two carriage returns. Each line is a series of ASCII characters representing a single number in hexadecimal notation. The interpretation of the lines is:

- Number of samples. For legacy reasons this field always returns 1.
- Digital channel mask. A bit-mask of all I/O capable pins in the system. The bits set to **1** are configured for digital I/O and are included in the digital data value below. Pins D0 - D9 are bits 0 - 9, and P0 - P2 are bits 10 - 12.
- Analog channel mask. The bits set to **1** are configured for analog I/O and have individual readings following the digital data field.
- Digital data. The current digital value of all the pins set in the digital channel mask, only present if at least one bit is set in the digital channel mask.
- Analog data. Additional lines, one for each set pin in the analog channel mask. Each reading is a 10-bit ADC value for a 2.5 V voltage reference.

API operating mode

In API operating mode, **IS** immediately returns an **OK** response.

The API response is ordered identical to the Command mode response with the same fields present. Each field is a binary number of the size listed in the following table. Multi-byte fields are in big-endian byte order.

Field	Size
Number of samples	1 byte
Digital channel mask	2 bytes
Analog channel mask	1 byte
Samples	2 bytes each

Parameter range

N/A

Default

N/A

Sleep commands

The following AT commands are sleep commands.

SM (Sleep Mode)

Sets or displays the sleep mode of the device.

The sleep mode determines how the device enters and exits a power saving sleep.

Sleep mode is also affected by the **SO** command, option bit 6. See [Sleep modes](#) for more information about sleep modes.

Parameter range

0, 1, 4, 5

Parameter	Description
0	Normal. In this mode the device never sleeps.
1	Pin Sleep. In this mode the device honors the SLEEP_RQ pin. Set D8 (DIO8/SLEEP_REQUEST) to the sleep request function: 1 .
4	Cyclic Sleep. In this mode the device repeatedly sleeps for the value specified by SP and spends ST time awake.
5	Cyclic Sleep with Pin Wake. In this mode the device acts as in Cyclic Sleep but does not sleep if the SLEEP_RQ pin is inactive, allowing the device to be kept awake or woken by the connected system.

Default

0

SP (Sleep Period)

Sets or displays the time to spend asleep in cyclic sleep modes. In Cyclic sleep mode, the node sleeps with CTS disabled for the sleep time interval, then wakes for the wake time interval.

Parameter range

0x1 - 0x83D600 (x 10 ms)

Default

0x7530 (5 minutes)

ST (Wake Time)

Sets or displays the time to spend awake in cyclic sleep modes.

Parameter range

0x1 - 0x36EE80 (x 1 ms)

Default

0xEA60 (60 seconds)

SO (Sleep Options)

Set or read the sleep options bit field of a device. This command is a bitmask.

Parameter range

0x0 - 0xFFFF

Bit field:

Bit	Setting	Meaning	Description
0x00	0	Connected sleep	On compatible hardware, enters a lower power consumption mode that maintains registration with the cellular network.
Set all other option bits to 0.			

Default

0

Command mode options

The following commands are Command mode option commands.

CC (Command Sequence Character)

The character value the device uses to enter Command mode.

The default value (**0x2B**) is the ASCII code for the plus (+) character. You must enter it three times within the guard time to enter Command mode. To enter Command mode, there is also a required period of silence before and after the command sequence characters of the Command mode sequence (**GT + CC + GT**). The period of silence prevents inadvertently entering Command mode.

Parameter range

0 - 0xFF

Default

0x2B (the ASCII plus character: +)

CT (Command Mode Timeout)

Sets or displays the Command mode timeout parameter. If a device does not receive any valid commands within this time period, it returns to Idle mode from Command mode.

Parameter range

2 - 0x1770 (x 100 ms)

Default

0x64 (10 seconds)

CN (Exit Command mode)

Immediately exits Command Mode and applies pending changes.

Note Whether Command mode is exited using the **CN** command or by **CT** timing out, changes are applied upon exit.

Parameter range

N/A

Default

N/A

GT (Guard Times)Set the required period of silence before and after the command sequence characters of the Command mode sequence (**GT + CC + GT**). The period of silence prevents inadvertently entering Command mode.**Parameter range**

0x2 - 0x6D3 (x 1 ms)

Default

0x3E8 (one second)

MicroPython commands

The following commands relate to using MicroPython on the XBee Smart Modem.

PS (Python Startup)

Sets whether or not the XBee Smart Modem runs the stored Python code at startup.

Range

0 - 1

Parameter	Description
0	Do not run stored Python code at startup.
1	Run stored Python code at startup.

Default

0

PY (MicroPython Command)

Interact with the XBee Smart Modem using MicroPython. **PY** is a command with sub-commands. These sub-commands are arguments to **PY**.

PYC(Code Report)

You can store compiled code in flash using the **Ctrl-F** command from the MicroPython REPL; refer to the [Digi MicroPython Programming Guide](#). The **PYC** sub-command reports details of the stored code. In Command mode, it returns three lines of text, for example:

```
source: 1662 bytes (hash=0xC3B3A813)
bytecode: 619 bytes (hash=0x0900DBCE)
compiled: 2017-05-09T15:49:44
```

The messages are:

- **source**: the size of the source code used to generate the bytecode and its 32-bit hash.
- **bytecode**: the size of bytecode stored in flash and its 32-bit hash. A size of **0** indicates that there is no stored code.
- **compiled**: a compilation timestamp. A timestamp of **2000-01-01T00:00:00** indicates that the clock was not set during compilation.

In API mode, **PYC** returns five 32-bit big-endian values:

- source size
- source hash
- bytecode size
- bytecode hash
- timestamp as seconds since 2000-01-01T00:00:00

PYD (Delete Code)

PYD interrupts any running code, erases any stored code and then does a soft-reboot on the MicroPython subsystem.

PYV (Version Report)

Report the MicroPython version.

PY^ (Interrupt Program)

Sends **KeyboardInterrupt** to MicroPython. This is useful if there is a runaway MicroPython program and you have filled the stdin buffer. You can enter Command mode (**+++**) and send **ATPY^** to interrupt the program.

Default

N/A

Firmware version/information commands

The following AT commands are firmware version/information commands.

VR (Firmware Version)

Reads the firmware version on a device.

Parameter range

0 - 0xFFFF [read-only]

Default

Set in firmware

VL (Verbose Firmware Version)

Shows detailed version information including the application build date and time.

Parameter range

N/A

Default

Set in firmware

HV (Hardware Version)

Display the hardware version number of the device.

Parameter range

0 - 0xFFFF [read-only]

Default

Set in firmware

AI (Association Indication)

Reads the Association status code to monitor association progress. The following table provides the status codes and their meanings.

Status code	Meaning
0x00	Connected to the Internet.
0x22	Registering to cellular network.
0x23	Connecting to the Internet.
0x24	The cellular component is missing, corrupt, or otherwise in error. The cellular component requires a new firmware image.
0x25	Cellular network registration denied.
0x2A	Airplane mode.
0x2B	USB Direct active.

Status code	Meaning
0x2F	Bypass mode active.
0xFF	Initializing.

Parameter range

0 - 0xFF [read-only]

Default

N/A

HS (Hardware Series)

Read the device's hardware series number.

Parameter range

N/A

Default

Set in the firmware

CK (Configuration CRC)

Displays the cyclic redundancy check (CRC) of the current AT command configuration settings.

Parameter range

0 - 0xFFFFFFFF

Default

N/A

Diagnostic interface commands

The following AT commands are diagnostic interface commands.

DI (Remote Manager Indicator)

Displays the current Remote Manager status for the XBee.

Range

Value	Description
0x00	Connected
0x01	Before connection to the Internet
0x02	Remote Manager connection in progress

Value	Description
0x03	Disconnecting from Remote Manager
0x04	Not configured for Remote Manager

Default

N/A

CI (Protocol/Connection Indication)

Displays information regarding the last IP connection (when the **IP** command = **0**, **1** or **4**) or SMS transmission (when **IP** = **2**).

The value for this parameter resets to **0xFF** when the device switches between **IP (IP Protocol)** modes.

When **IP** is set to **0**, **1**, or **4** (UDP, TCP, over SSL over TCP), **CI** resets to **0xFF** when you apply changes to any of the following settings:

- [DL \(Destination Address\)](#)
- [DE \(Destination Port\)](#)
- [TM \(IP Client Connection Timeout\)](#)

When **IP** is set to **2** (SMS), **CI** resets to **0xFF** when **P# (Destination Phone Number)** is changed.

The following table provides the parameter's meaning when **IP** = **0** for UDP connections.

Parameter	Description
0x00	The socket is open.
0x01	Tried to send but could not.
0x02	Invalid parameters (bad IP/host).
0x03	TCP not supported on this cellular component.
0x10	Not registered to the cell network.
0x11	Cellular component not identified yet.
0x12	DNS query lookup failure.
0x13	Socket leak
0x20	Bad handle.
0x21	User closed.
0x22	Unknown server - DNS lookup failed.
0x23	Connection lost.
0x24	Unknown.
0xFF	No known status.

The following table provides the parameter's meaning when **IP** = **1** or **4** for TCP connections.

Parameter	Description
0x00	The socket is open.
0x01	Tried to send but could not.
0x02	Invalid parameters (bad IP/host).
0x03	TCP not supported on this cellular component.
0x10	Not registered to the cell network.
0x11	Cellular component not identified yet.
0x12	DNS query lookup failure.
0x13	Socket leak
0x20	Bad handle.
0x21	User closed.
0x22	No network registration.
0x23	No internet connection.
0x24	No server - timed out on connection.
0x25	Unknown server - DNS lookup failed.
0x26	Connection refused.
0x27	Connection lost.
0x28	Unknown.
0xFF	No known status.

The following table provides the parameter's meaning when **IP = 2** for SMS connections.

Parameter	Description
0x00	SMS successfully sent.
0x01	SMS failed to send.
0x02	Invalid SMS parameters - check P# (Destination Phone Number) .
0x03	SMS not supported.
0x10	No network registration.
0x11	Cellular component stack error.
0x13	Socket leak
0xFF	No SMS state to report (no SMS messages have been sent).

Parameter range

0 - 0xFF (read-only)

Default

-

Execution commands

The location where most AT commands set or query register values, execution commands execute an action on the device. Execution commands are executed immediately and do not require changes to be applied.

NR (Network Reset)

NR resets the network layer parameters.

The XBee Smart Modem responds immediately with an **OK** on the UART and then causes a network restart.

If **NR = 0**, the XBee Smart Modem tears down any TCP/UDP sockets and resets Internet connectivity. You can also send **NR**, which acts like **NR = 0**.

Parameter range

0

Default

N/A

!R (Modem Reset)

Forces the cellular component to reboot.



CAUTION! This command is for advanced users, and you should only use it if the cellular component becomes completely stuck while in Bypass mode. Normal users should never need to run this command. See the [FR \(Force Reset\)](#) command instead.

Range

N/A

Default

N/A

File system commands

To access the file system, [Enter Command mode](#) and use the following commands. All commands block the AT command processor until completed and only work from Command mode; they are not valid for API mode or MicroPython's `xbbe.atcmd()` method. Commands are case-insensitive as are file and directory names. Optional parameters are shown in square brackets ([]).

FS is a command with sub-commands. These sub-commands are arguments to **FS**.

For **FS** commands, you have to type **AT** before the command, for example **ATFS PWD**, **ATFS LS** and so forth.

Error responses

If a command succeeds it returns information such as the name of the current working directory or a list of files, or **OK** if there is no information to report. If it fails, you see a detailed error message instead of the typical **ERROR** response for a failing AT command. The response is a named error code and a textual description of the error.

Note The exact content of error messages may change in the future. All errors start with a capital **E**, followed by one or more uppercase letters and digits, a space, and an description of the error. If writing your own AT command parsing code, you can determine if an **FS** command response is an error by checking if the first letter of the response is capital **E**.

ATFS (File System)

When sent without any parameters, **FS** prints a list of supported commands.

ATFS PWD

Prints the current working directory, which always starts with **/** and defaults to **/flash** at startup.

ATFS CD *directory*

Changes the current working directory to **directory**. Prints the current working directory or an error if unable to change to **directory**.

ATFS MD *directory*

Creates the directory **directory**. Prints **OK** if successful or an error if unable to create the requested directory.

ATFS LS [*directory*]

Lists files and directories in the specified directory. The **directory** parameter is optional and defaults to a period (**.**), which represents the current directory. The list ends with a blank line.

Entries start with zero or more spaces, followed by filesize or the string **<DIR>** for directories, then a single space character and the name of the entry. Directory names end with a forward slash (**/**) to differentiate them from files. Secure files end with a hash mark (**#**) and you cannot download them.

```
<DIR> ./
<DIR> ../
<DIR> cert/
<DIR> lib/
    32 test.txt
    1234 secure.bin#
```

ATFS PUT *filename*

Starts a YMODEM receive on the XBee Smart Modem, storing the received file to filename and ignoring the filename that appears in block 0 of the YMODEM transfer. The XBee Smart Modem sends a prompt (**Receiving file with YMODEM...**) when it is ready to receive, at which point you should initiate a YMODEM send in your terminal emulator.

If the command is incorrect, the reply will be an error as described in [Error responses](#).

ATFS XPUT filename

Similar to the **PUT** command, but stores the file securely on the XBee Smart Modem. See [Secure files](#) for details on what this means.

If the command is incorrect, the reply will be an error as described in [Error responses](#).

ATFS HASH filename

Print a sha256 hash of a secure file uploaded via the **XPUT** command to allow for verification against a local copy of the file. On Windows, you can generate a SHA256 hash of a file with the command **certutil -hashfile test.txt SHA256**. On Mac and Linux use **shasum -b -a 256 test.txt**.

ATFS GET filename

Starts a YMODEM send of **filename** on the XBee device. When it is ready to send, the XBee Smart Modem sends a prompt: (**Sending file with YMODEM...**). When the prompt is sent, you should initiate a YMODEM receive in your terminal emulator.

If the command is incorrect, the reply will be an error as described in [Error responses](#).

ATFS MV source_path dest_path

Moves or renames the selected file or directory **source_path** to the new name or location **dest_path**. This command fails with an error if **source_path** does not exist, or **dest_path** already exists.

Note Unlike a computer's command prompt which moves a file into the **dest_path** if it is an existing directory, you must specify the full name for **dest_path**.

ATFS RM file_or_directory

Removes the file or empty directory specified by **file_or_directory**. This command fails with an error if **file_or_directory** does not exist, is not empty, refers to the current working directory or one of its parents.

ATFS INFO

Report on the size of the filesystem, showing bytes in use, available, marked bad and total. The report ends with a blank line, as with most multi-line AT command output. Example output:

```
204800 used
695296 free
    0 bad
900096 total
```

ATFS FORMAT confirm

Reformats the file system, leaving it with a default directory structure. Pass the word **confirm** as the first parameter to confirm the format. The XBee Smart Modem responds with **Formatting...**, adds a period every second until the format is complete and ends the response with a carriage return.

Operate in API mode

API mode overview	147
Use the AP command to set the operation mode	147
API frame format	147

API mode overview

As an alternative to Transparent operating mode, you can use API operating mode. API mode provides a structured interface where data is communicated through the serial interface in organized packets and in a determined order. This enables you to establish complex communication between devices without having to define your own protocol. The API specifies how commands, command responses and device status messages are sent and received from the device using the serial interface or the SPI interface.

We may add new frame types to future versions of firmware, so build the ability to filter out additional API frames with unknown frame types into your software interface.

Use the AP command to set the operation mode

Use [AP \(API Enable\)](#) to specify the operation mode:

AP command setting	Description
AP = 0	Transparent operating mode, UART serial line replacement with API modes disabled. This is the default option.
AP = 1	API operation.
AP = 2	API operation with escaped characters (only possible on UART).
AP = 3	N/A
AP = 4	MicroPython REPL
AP = 5	Bypass mode. This mode is for direct communication with the underlying chip and is only for advanced users.

The API data frame structure differs depending on what mode you choose.

API frame format

An API frame consists of the following:

- Start delimiter
- Length
- Frame data
- Checksum

API operation (AP parameter = 1)

This is the recommended API mode for most applications. The following table shows the data frame structure when you enable this mode:

Frame fields	Byte	Description
Start delimiter	1	0x7E
Length	2 - 3	Most Significant Byte, Least Significant Byte
Frame data	4 - number (n)	API-specific structure
Checksum	n + 1	1 byte

Any data received prior to the start delimiter is silently discarded. If the frame is not received correctly or if the checksum fails, the XBee replies with a radio status frame indicating the reason for the failure.

API operation with escaped characters (AP parameter = 2)

Setting API to 2 allows escaped control characters in the API frame. Due to its increased complexity, we only recommend this API mode in specific circumstances. API 2 may help improve reliability if the serial interface to the device is unstable or malformed frames are frequently being generated.

When operating in API 2, if an unescaped 0x7E byte is observed, it is treated as the start of a new API frame and all data received prior to this delimiter is silently discarded. For more information on using this API mode, see the [Escaped Characters and API Mode 2](#) in the Digi Knowledge base.

API escaped operating mode works similarly to API mode. The only difference is that when working in API escaped mode, the software must escape any payload bytes that match API frame specific data, such as the start-of-frame byte (0x7E). The following table shows the structure of an API frame with escaped characters:

Frame fields	Byte	Description	
Start delimiter	1	0x7E	
Length	2 - 3	Most Significant Byte, Least Significant Byte	Characters escaped if needed
Frame data	4 - n	API-specific structure	
Checksum	n + 1	1 byte	

Start delimiter field

This field indicates the beginning of a frame. It is always 0x7E. This allows the device to easily detect a new incoming frame.

Escaped characters in API frames

If operating in API mode with escaped characters (AP parameter = 2), when sending or receiving a serial data frame, specific data values must be escaped (flagged) so they do not interfere with the data frame sequencing. To escape an interfering data byte, insert 0x7D and follow it with the byte to be escaped (XORed with 0x20).

The following data bytes need to be escaped:

- 0x7E: start delimiter
- 0x7D: escape character
- 0x11: XON
- 0x13: XOFF

To escape a character:

1. Insert 0x7D (escape character).
2. Append it with the byte you want to escape, XORed with 0x20.

In API mode with escaped characters, the length field does not include any escape characters in the frame and the firmware calculates the checksum with non-escaped data.

Example: escape an API frame

To express the following API non-escaped frame in API operating mode with escaped characters:

Start delimiter	Length	Frame type	Frame Data	Checksum
			Data	
7E	00 0F	17	01 00 13 A2 00 40 AD 14 2E FF FE 02 4E 49 6D	

You must escape the 0x13 byte:

1. Insert a 0x7D.
2. XOR byte 0x13 with 0x20: $13 \oplus 20 = 33$

The following figure shows the resulting frame. Note that the length and checksum are the same as the non-escaped frame.

Start delimiter	Length	Frame type	Frame Data	Checksum
			Data	
7E	00 0F	17	01 00 7D 33 A2 00 40 AD 14 2E FF FE 02 4E 49 6D	

The length field has a two-byte value that specifies the number of bytes in the frame data field. It does not include the checksum field.

Length field

The length field is a two-byte value that specifies the number of bytes contained in the frame data field. It does not include the checksum field.

Frame data

This field contains the information that a device receives or will transmit. The structure of frame data depends on the purpose of the API frame:

	Length		Frame data								n+1	
	1	2	Data									
0x7E	MSB	LSB	4	5	6	7	8	9	...	n		
				Data								

- **Frame type** is the API frame type identifier. It determines the type of API frame and indicates how the Data field organizes the information.
- **Data** contains the data itself. This information and its order depend on the what type of frame that the Frame type field defines.

Multi-byte values are sent big-endian.

Calculate and verify checksums

To calculate the checksum of an API frame:

1. Add all bytes of the packet, except the start delimiter 0x7E and the length (the second and third bytes).
2. Keep only the lowest 8 bits from the result.
3. Subtract this quantity from 0xFF.

To verify the checksum of an API frame:

1. Add all bytes including the checksum; do not include the delimiter and length.
2. If the checksum is correct, the last two digits on the far right of the sum equal 0xFF.

Example

Consider the following sample data packet: **7E 00 0A 01 01 50 01 00 48 65 6C 6C 6F B8+**

Byte(s)	Description
7E	Start delimiter
00 0A	Length bytes
01	API identifier
01	API frame ID
50 01	Destination address low
00	Option byte
48 65 6C 6C 6F	Data packet
B8	Checksum

To calculate the check sum you add all bytes of the packet, excluding the frame delimiter **7E** and the length (the second and third bytes):

7E 00 0A 01 01 50 01 00 48 65 6C 6C 6F B8

Add these hex bytes:

$$01 + 01 + 50 + 01 + 00 + 48 + 65 + 6C + 6C + 6F = 247$$

Now take the result of 0x247 and keep only the lowest 8 bits which in this example is 0xC4 (the two far right digits). Subtract 0x47 from 0xFF and you get 0x3B (0xFF - 0xC4 = 0x3B). 0x3B is the checksum for this data packet.

If an API data packet is composed with an incorrect checksum, the XBee Smart Modem will consider the packet invalid and will ignore the data.

To verify the check sum of an API packet add all bytes including the checksum (do not include the delimiter and length) and if correct, the last two far right digits of the sum will equal FF.

$$01 + 01 + 50 + 01 + 00 + 48 + 65 + 6C + 6C + 6F + B8 = 2FF$$

API frames

The following sections describe the API frames.

AT Command - 0x08	152
Transmit (TX) SMS - 0x1F	153
Transmit (TX) Request: IPv4 - 0x20	154
Tx Request with TLS Profile - 0x23	156
AT Command Response - 0x88	158
Transmit (TX) Status - 0x89	159
Modem Status - 0x8A	161
Receive (RX) Packet: SMS - 0x9F	162
Receive (RX) Packet: IPv4 - 0xB0	163

AT Command - 0x08

Description

Use this frame to query or set parameters on the local device. Changes this frame makes to device parameters take effect after executing the AT command.

Format

The following table provides the contents of the frame. For details on frame structure, see [API frame format](#).

Field name	Field value	Data type	Description
Frame type	0x08	Byte	
Frame ID		Byte	Identifies the data frame for the host to correlate with a subsequent ACK. If set to 0 , the device does not send a response.
AT command		Byte	Command name: two ASCII characters that identify the AT command.
Parameter value		Byte	If present, indicates the requested parameter value to set the given register. If no characters are present, it queries the register.

Transmit (TX) SMS - 0x1F

Description

Transmit an SMS message. The frame allows international numbers with or without the + prefix. If you omit + and are dialing internationally, you need to include the proper International Dialing Prefix for your calling region, for example, 011 for the United States.

Format

The following table provides the contents of the frame. For details on frame structure, see [API frame format](#).

Field name	Field value	Data type	Description
Frame type	0x1F	Byte	
Frame ID		Byte	Reference identifier used to match status responses. 0 disables the TX Status frame.
Options		Byte	Reserved for future use.
Phone number		20 byte string	String representation of phone number terminated with a null (0x0) byte. Use numbers and the + symbol only, no other symbols or letters.
Payload		Variable (160 characters maximum)	Data to send as the body of the SMS message.

Transmit (TX) Request: IPv4 - 0x20

Description

A TX Request message causes the device to transmit data in IPv4 format. A TX request frame for a new destination creates a network socket. After the network socket is established, data from the network that is received on the socket is sent out the device's serial port in the form of a Receive (RX) Packet frame.

Format

The following table provides the contents of the frame. For details on frame structure, see [API frame format](#).

Field name	Field value	Data type	Description
Frame type	0x20	Byte	
Frame ID		Byte	Reference identifier used to match status responses. 0 disables the TX Status frame.
Destination address		32-bit big endian	
Destination port		16-bit big endian	
Source port		16-bit big endian	If the source port is 0 , the device attempts to send the frame data using an existing open socket with a destination that matches the destination address and destination port fields of this frame. If there is no matching socket, then the device attempts to open a new socket. If the source port is non-zero, the device attempts to send the frame data using an existing open socket with a source and destination that matches the source port, destination address, and destination port fields of this frame. If there is no matching socket, it returns an error.
Protocol		Byte	0 = UDP 1 = TCP 4 = SSL over TCP
Transmit options		Byte bitfield	Bit fields are offset 0 Bit field 0 - 7. Bits 0, and 2-7 are reserved, bit 1 is not. BIT 1 = 1 - Terminate the TCP socket after transmission is complete 0 - Leave the socket open. Closed by timeout, see TM (IP Client Connection Timeout) . Ignore this bit for UDP packets. All other bits are reserved and should be 0 .

Field name	Field value	Data type	Description
Payload		Variable	Data to be transferred to the destination, may be up to 1500 bytes.

Tx Request with TLS Profile - 0x23

Description

The frame gives greater control to the application over the TLS settings used for a connection.

A TX Request with TLS Profile frame implies the use of TLS and behaves similar to the TX Request (0x20) frame, with the protocol field replaced with a TLS Profile field to choose from the profiles configured with the \$0, \$1, and \$2 configuration commands.

Format

The following table provides the contents of the frame. For details on frame structure, see [API frame format](#).

Field name	Field value	Data type	Description
Frame type	0x23	Byte	
Frame ID		Byte	Reference identifier used to match status responses. 0 disables the TX Status frame.
Destination address		32-bit big endian	
Destination port		16-bit big endian	
Source port		16-bit big endian	If the source port is 0 , the device attempts to send the frame data using an existing open socket with a destination that matches the destination address and destination port fields of this frame. If there is no matching socket, then the device attempts to open a new socket. If the source port is non-zero, the device attempts to send the frame data using an existing open socket with a source and destination that matches the source port, destination address, and destination port fields of this frame. If there is no matching socket, the TX Status frame returns an error.
TLS profile		Byte	Zero-indexed number that indicates the profile as specified by the corresponding \$<num> command.
Transmit options		Byte bitfield	Bit fields are offset 0 Bit field 0 - 7. Bits 0, and 2-7 are reserved, bit 1 is not. BIT 1 = 1 - Terminate the TCP socket after transmission is complete 0 - Leave the socket open. Closed by timeout, see TM (IP Client Connection Timeout) . Ignore this bit for UDP packets. All other bits are reserved and should be 0 .

Field name	Field value	Data type	Description
Payload		Variable	Data to be transferred to the destination, may be up to 1500 bytes.

AT Command Response - 0x88

Description

A device sends this frame in response to an AT Command (0x08) frame. Some commands send back multiple frames.

Format

The following table provides the contents of the frame. For details on frame structure, see [API frame format](#).

Field name	Field value	Data type	Description
Frame type	0x88	Byte	
Frame ID		Byte	Identifies the data frame for the host to correlate with a subsequent ACK. If set to 0 , the device does not send a response.
AT command		Byte	Command name: two ASCII characters that identify the AT command.
Status	##	Byte	0 = OK 1 = ERROR 2 = Invalid command 3 = Invalid parameter
Parameter value		Byte	Register data in binary format. If the register was set, then this field is not returned.

Transmit (TX) Status - 0x89

Description

Indicates the success or failure of a transmit operation.

Format

The following table provides the contents of the frame. For details on frame structure, see [API frame format](#).

Field name	Field value	Data type	Description
Frame type	0x89	Byte	
Frame ID		Byte	Refers to the frame ID specified in a previous transmit frame
Status		Byte	Status code (see the table below)

The following table shows the status codes.

Code	Description
0x0	Successful transmit
0x21	Failure to transmit to cell network
0x22	Not registered to cell network
0x2c	Invalid frame values (check the phone number)
0x31	Internal error
0x32	Resource error (retry operation later)
0x74	Message too long
0x78	Invalid UDP port
0x79	Invalid TCP port
0x7A	Invalid host address
0x7B	Invalid data mode
0x80	Connection refused
0x81	Socket connection lost
0x82	No server
0x83	Socket closed

Code	Description
0x84	Unknown server
0x85	Unknown error
0x86	Invalid TLS configuration (missing file, and so forth)

Modem Status - 0x8A

Description

Cellular component status messages are sent from the device in response to specific conditions.

Format

The following table provides the contents of the frame. For details on frame structure, see [API frame format](#).

Field name	Field value	Data type	Description
Frame type	0x8A	Byte	
Status	##	Byte	0 = Hardware reset or power up 1 = Watchdog timer reset 2 = Registered with cellular network 3 = Unregistered with cellular network 0x0E = Remote Manager connected 0x0F = Remote Manager disconnected

Receive (RX) Packet: SMS - 0x9F

Description

This XBee Smart Modem uses this frame when it receives an SMS message.

Format

The following table provides the contents of the frame. For details on frame structure, see [API frame format](#).

Field name	Field value	Data type	Description
Frame Type	0x9F	Byte	
Phone number		20 byte string	String representation of the phone number, padded out with null bytes (0x0).
Payload		Variable	Body of the received SMS message.

Receive (RX) Packet: IPv4 - 0xB0

Description

The XBee Smart Modem uses this frame when it receives RF data on a network socket that is created by a TX request frame or configuring [C0 \(Source Port\)](#).

Format

The following table provides the contents of the frame. For details on frame structure, see [API frame format](#).

Frame data fields	Offset	Description
Frame type	3	0xB0
IPv4 32-bit source address	MSB 4	The address in the example below is for a source address of 192.168.0.104 . 32-bit big endian.
	5	
	6	
	7	
16-bit destination port	MSB 8	The port that the packet was received on. 16-bit big endian.
	LSB 9	
16-bit source port	MSB 10	The port that the packet was sent from. 16-bit big endian.
	LSB 11	
Protocol	MSB 12	0 = UDP 1 = TCP 4 = SSL over TCP
Status	13	Reserved
Payload	14	Data received from the source. The maximum size is 1500 bytes.
	15	
	16	
	17	
	18	

Configure the XBee Smart Modem using Digi Remote Manager

Use Digi Remote Manager (<https://remotemanager.digi.com/>) to perform the operations in this section. Each operation requires that you enable Remote Manager with the **DO** command and that you connect the XBee Smart Modem to an access point that has an external Internet connection to allow access to Digi Remote Manager.

Note Digi is consolidating our cloud services, Digi Device Cloud and Digi Remote Manager®, under the Remote Manager name. This phased process does not affect device functionality or the functionality of the web services and other features. However, customers will find that some user interface and firmware functionality mention both Device Cloud and Digi Remote Manager.

Create a Remote Manager account	165
Get the XBee Smart Modem IMEI number	165
Add a XBee Smart Modem to Remote Manager	165
Update the firmware	166
Update the firmware using web services	166

Create a Remote Manager account

Digi Remote Manager is an on-demand service with no infrastructure requirements. Remote devices and enterprise business applications connect to Remote Manager through standards-based web services. This section describes how to configure and manage an XBee using Remote Manager. For detailed information on using Remote Manager, refer to the Remote Manager User Guide, available via the Documentation tab in Remote Manager.

Before you can manage an XBee with Remote Manager, you must create a Remote Manager account. To create a Remote Manager account:

1. Go to <https://www.digi.com/products/cloud/digi-remote-manager>.
2. Click **30 DAY FREE TRIAL/LOGIN**.
3. Follow the online instructions to complete account registration. You can upgrade your Developer account to a paid account at any time.

When you are ready to deploy multiple XBee Smart Modems in the field, upgrade your account to access additional Remote Manager features.

Get the XBee Smart Modem IMEI number

Before adding an XBee to your Remote Manager account inventory, you need to determine the International Mobile Equipment Identity (IMEI) number for the device. Use XCTU to view the IMEI number by querying the **IM** parameter.

Add a XBee Smart Modem to Remote Manager

To add an XBee to your Remote Manager account inventory, follow these steps:

Go to <https://remotemanager.digi.com/>.

1. Log in to your account.
2. Click **Device Management > Devices**.
3. Click **Add Devices**. The Add Devices dialog appears.
4. Select **IMEI #**, and type or paste the IMEI number of the XBee you want to add. The **IM (IMEI)** command provides this number.

The screenshot shows the 'Add Devices' dialog box. It has a title bar with a close button. The main content area contains the following text: 'For each device you want to add:' followed by a bulleted list: 'Enter the device MAC address. Or, if there is no MAC address, enter the IMEI number or device ID.', 'If the device requires an installation code, enter the installation code.', 'Click Add.', and 'When you are finished adding devices, click OK.' Below this is a link: 'Click here for details.' There are three input fields: 'IMEI #' with a dropdown menu showing 'IMEI #' and an 'Add' button; 'Install Code:' with an empty text box; and a tabbed interface with 'MAC Address', 'Device ID', and 'Install Code' tabs, and a 'Remove' button. At the bottom, there is a scrollable area with the text 'No devices to add' and 'OK' and 'Cancel' buttons.

5. Click **Add** to add the device. The XBee is added to your inventory.
6. Click **OK** to close the Add Devices dialog and return to the Devices view.

Update the firmware

XBee Smart Modem supports Remote Manager firmware updates. To perform a firmware update:

1. Download the updated firmware file for your device from [Digi's support site](#). This is a zip file containing .ebin and .mxi files for import.
2. Unzip the file.
3. In your Remote Manager account, click **Device Management > Devices**.
4. Select the first device you want to update.
5. To select multiple devices (must be of the same type), press the Control key and select additional devices.
6. Click **More** in the Devices toolbar and select **Update Firmware** from the Update category of the More menu. The Update Firmware dialog appears.
7. Click **Browse** to select the .ebin file that you unzipped earlier.
8. Click **Update Firmware**. The updated devices automatically reboot when the updates are complete.

Update the firmware using web services

Remote Manager supports both synchronous and asynchronous firmware update using web services. The following examples show how to perform an asynchronous firmware update. See the Remote Manager [documentation](#) for more details on firmware updates.

Note You must use XCTU to update the cellular component's firmware.

1. Download the updated firmware file for your device from [Digi's support site](#). This is a zip file containing .ebin and .mxi files for import.
2. Unzip the file and locate the .ebin inside the unzipped directory.
3. Send an HTTP SCI request to Remote Manager with the contents of the .ebin file converted to base64 data; see the following example.

Example: update the XBee firmware synchronously with Python 3.0

```
import base64
import requests

# Location of firmware image
firmware_path = 'XBXC.ebin'

# Remote Manager device ID of the device being updated
device_id = '00010000-00000000-03526130-70153378'

# Remote Manager username and password
username = "my_Remote_manager_username"
password = "my_remote_manager_password"

url = 'https://remotemanager.digi.com/ws/sci'
```

```

# Get firmware image
fw_file = open(firmware_path, 'rb')
fw_data = fw_file.read()
fw_data = base64.encodebytes(fw_data).decode('utf-8')

# Form update_firmware request
data = """
<sci_request version="1.0">
  <update_firmware filename="firmware.ebin">
    <targets>
      <device id="{}/>
    </targets>
    <data>{}</data>
  </update_firmware>
</sci_request>
""".format(device_id, fw_data)

# Post request
r = requests.post(url, auth=(username, password), data=data)
if (r.status_code != 200) or ("error" in r.content.decode('utf-8')):
    print("firmware update failed")
else:
    print("firmware update success")

```

Example: use the device's firmware image to update the XBee firmware synchronously

To update the XBee firmware synchronously with Python 3.0, but using the device firmware image already uploaded to Remote Manager, upload the device's *.ebin firmware to Remote Manager:

1. Download the updated firmware file for your device from [Digi's support site](#). This is a zip file containing .ebin and .mxi files for import.
2. Unzip the file and locate the .ebin inside the unzipped directory.
3. Log in to Remote Manager.
4. Click the **Data Services** tab.
5. Click **Data Files**.
6. Click **Upload Files**; browse and select the *.ebin firmware file to upload it.
7. Send an HTTP SCI request to Remote manager with the path of the .ebin file; see the example below.

```

import base64
import requests

# Location of firmware image on Remote Manager
firmware_path = '~/XBXC.ebin'

# Remote Manager device ID of the device being updated
device_id = '00010000-00000000-03526130-70153378'

# Remote Manager username and password
username = "my_remote_manager_username"
password = "my_remote_manager_password"

```

```
url = 'https://remotemanager.digi.com/ws/sci'

# Form update_firmware request
data = """
<sci_request version="1.0">
  <update_firmware filename="firmware.ebin">
    <targets>
      <device id="{}/>
    </targets>
    <file>{}</file>
  </update_firmware>
</sci_request>
""".format(device_id, firmware_path)

# Post request
r = requests.post(url, auth=(username, password), data=data)
if (r.status_code != 200) or ("error" in r.content.decode('utf-8')):
    print("firmware update failed")
else:
    print("firmware update success")
```

Troubleshooting

This section contains troubleshooting steps for the XBee Smart Modem.

Cannot find the serial port for the device	170
Correct a macOS Java error	172
Unresponsive cellular component in Bypass mode	173
Not on expected network after APN change	174
Syntax error at line 1	174
Error Failed to send SMS	174

Cannot find the serial port for the device

Condition

In XCTU, the serial port that your device is connected to does not appear.

Solution

1. Click the **Discover radio modules** button .
2. Select all of the ports to be scanned.
3. Click **Next** and then **Finish**. A dialog notifies you of the devices discovered and their details.

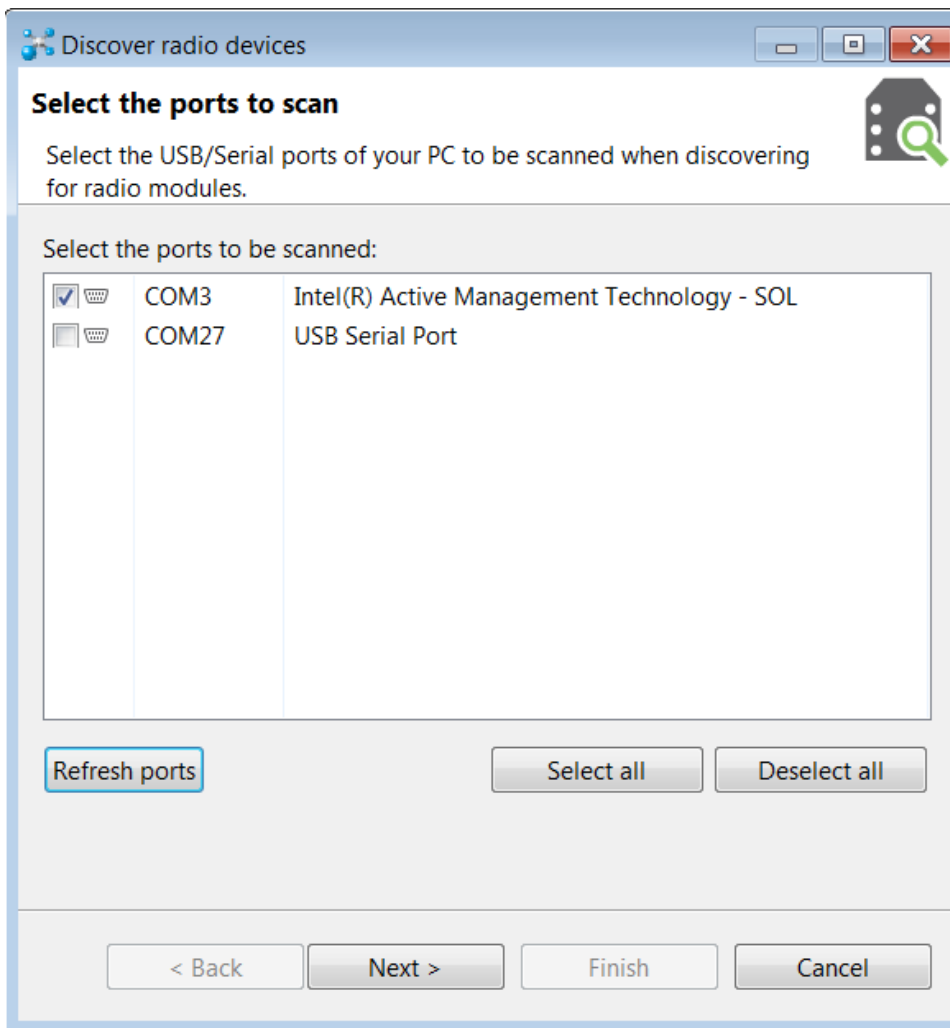

4. Remove the development board from the USB port and view which port name no longer appears in the **Discover radio devices** list of ports. The port name that no longer appears is the correct port for the development board.

Other possible issues

Other reasons that the XBee Smart Modem is not discoverable include:

1. If you accidentally have the loopback pins jumpered.
2. You may not have a driver installed. If you do not have a driver installed, the item will have an exclamation point icon next to it in the [Windows Device Manager](#).
3. You may not be using an updated FTDI driver.
 - a. Click [here](#) to download the drivers for your operating system.
 - b. This may require you to reboot your computer.
 - c. Disconnect the power and USB from the XBIB-U-DEV board and reconnect it.
4. If you have a driver installed and updated but still have issues, on Windows 10 you may have to enable VCP on the driver; see [Enable Virtual COM port \(VCP\) on the driver](#).

Enable Virtual COM port (VCP) on the driver

On Windows 10 computers, if XCTU does not see the devices you have attached to a PC, you may need to enable VCP on the USB driver.

To enable VCP:

1. Click the **Search**  button.
2. Type **Device Manager** to search for it.
3. Click **Universal Serial Bus controllers**.
4. If it displays more than one USB controller, unplug the XBee Smart Modem and plug it back in to make sure you choose the correct one.
5. Right-click the USB controller and select **Properties**; a dialog displays.
6. Select the **Advanced** tab.
7. Check **Load VCP**.
8. Click **OK**.
9. Unplug the board and plug it back in.

Correct a macOS Java error

When you use XCTU on macOS computer, you may encounter a Java error.

Condition

When opening XCTU for the first time on a macOS computer, you may see the following error:

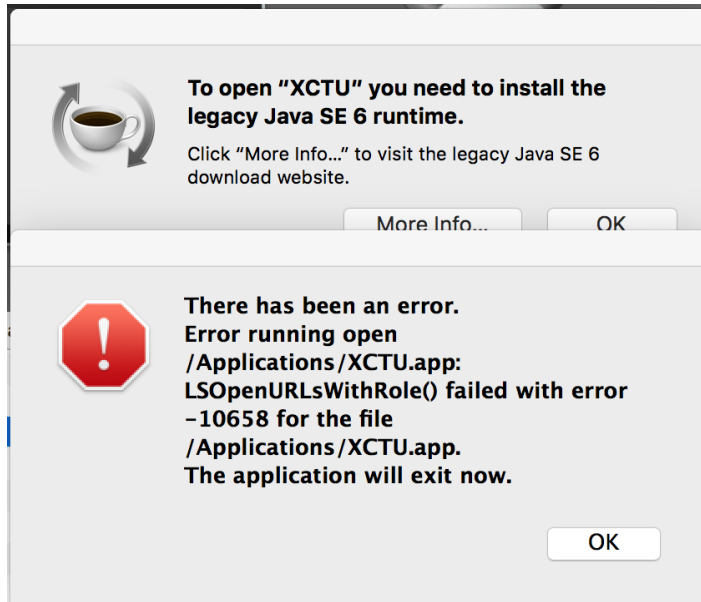

Solution

1. Click **More info** to open a browser window.
2. Click **Download** to get the file javaforosx.dmg.
3. Double-click on the downloaded javaforosx.dmg.
4. In the dialog, double-click the JavaForOSX.pkg and follow the instructions to install Java.

Unresponsive cellular component in Bypass mode

When in Bypass mode, the XBee Smart Modem does not automatically reset or reboot the cellular component if it becomes unresponsive.

Condition

In Bypass mode, the XBee Smart Modem does not respond to commands.

Solution

1. Query the [AI \(Association Indication\)](#) parameter to determine whether the cellular component is connected to the XBee Smart Modem software. If **AI** is **0x2F**, Bypass mode should work. If not, look at the status codes in [AI \(Association Indication\)](#) for guidance.
2. You can send the [!R \(Modem Reset\)](#) command to reset only the cellular component.

Not on expected network after APN change

Condition

The XBee Smart Modem is not on the expected network after a change to the [AN \(Access Point Name\)](#) command.

Solution

Send **ATNRO** to reset Internet connectivity. See [NR \(Network Reset\)](#) for more information.

Syntax error at line 1

You may get a **syntax error at line 1** error after pasting example MicroPython code and pressing **Ctrl+D**.

Solution

This commonly happens when you accidentally type a character at the beginning of line 1 before pasting the code.

Error Failed to send SMS

In MicroPython, you consistently get **Error Failed to send SMS** messages.

Solution

Your device cannot connect to the cell network. The reason may be:

1. The antenna is improperly or loosely connected.
2. The device is at a location where cellular service cannot reach. If the device is connected to the network, the red LED blinks about twice in a second. If it is not connected it does not blink; see [The Associate LED](#).
3. Your SIM card is out of SMS text quota.
4. The device is not getting enough current, for example if power is being supplied only by USB to the XBIB development board, rather than using an additional external power supply.

Regulatory information

Modification statement	176
Interference statement	176
FCC Class B digital device notice	176
RF exposure	177
FCC-approved antennas	177
Labeling requirements for the host device	178

Modification statement

Digi International has not approved any changes or modifications to this device by the user. Any changes or modifications could void the user's authority to operate the equipment.

Digi International n'approuve aucune modification apportée à l'appareil par l'utilisateur, quelle qu'en soit la nature. Tout changement ou modification peuvent annuler le droit d'utilisation de l'appareil par l'utilisateur.

Interference statement

This device complies with Part 15 of the FCC Rules and Industry Canada license-exempt RSS standard (s). Operation is subject to the following two conditions: (1) this device may not cause interference, and (2) this device must accept any interference, including interference that may cause undesired operation of the device.

Le présent appareil est conforme aux CNR d'Industrie Canada applicables aux appareils radio exempts de licence. L'exploitation est autorisée aux deux conditions suivantes : (1) l'appareil ne doit pas produire de brouillage, et (2) l'utilisateur de l'appareil doit accepter tout brouillage radioélectrique subi, même si le brouillage est susceptible d'en compromettre le fonctionnement.

FCC Class B digital device notice

This equipment has been tested and found to comply with the limits for a Class B digital device, pursuant to part 15 of the FCC Rules. These limits are designed to provide reasonable protection against harmful interference in a residential installation. This equipment generates, uses and can radiate radio frequency energy and, if not installed and used in accordance with the instructions, may cause harmful interference to radio communications. However, there is no guarantee that interference will not occur in a particular installation. If this equipment does cause harmful interference to radio or television reception, which can be determined by turning the equipment off and on, the user is encouraged to try to correct the interference by one or more of the following measures:

- Reorient or relocate the receiving antenna.
- Increase the separation between the equipment and receiver.
- Connect the equipment into an outlet on a circuit different from that to which the receiver is connected.
- Consult the dealer or an experienced radio/TV technician for help.

IMPORTANT: The RF module has been certified for mobile and base radio applications. If the module will be used for portable applications, the device must undergo SAR testing.

This equipment has been tested and found to comply with the limits for a Class B digital device, pursuant to Part 15 of the FCC Rules. These limits are designed to provide reasonable protection against harmful interference in a residential installation. This equipment generates, uses and can radiate radio frequency energy and, if not installed and used in accordance with the instructions, may cause harmful interference to radio communications. However, there is no guarantee that interference will not occur in a particular installation.

If this equipment does cause harmful interference to radio or television reception, which can be determined by turning the equipment off and on, the user is encouraged to try to correct the interference by one or more of the following measures: Re-orient or relocate the receiving antenna, Increase the separation between the equipment and receiver, Connect equipment and receiver to outlets on different circuits, or Consult the dealer or an experienced radio/TV technician for help.

RF exposure



CAUTION! This equipment is approved for mobile and base station transmitting devices only. Antenna(s) used for this transmitter must be installed to provide a separation distance of at least 25 cm from all persons and must not be co-located or operating in conjunction with any other antenna or transmitter.



ATTENTION! Cet équipement est approuvé pour la mobile et la station base dispositifs d'émission seulement. Antenne(s) utilisé pour cet émetteur doit être installé pour fournir une distance de séparation d'au moins 25 cm à partir de toutes les personnes et ne doit pas être situé ou fonctionner en conjonction avec tout autre antenne ou émetteur.

FCC-approved antennas

The can be installed using antennas and cables constructed with non-standard connectors (RPSMA, RPTNC, and so forth) An adapter cable may be necessary to attach the XBee connector to the antenna connector.

The modules are FCC approved for fixed base station and mobile applications for the channels indicated in the tables below. If the antenna is mounted at least 25 cm from nearby persons, the application is considered a mobile application.

The antennas below have been approved for use with this module. Digi does not carry all of these antenna variants. Contact Digi Sales for available antennas.

Bluetooth antennas

The following tables cover the antennas that are approved for use with the Bluetooth radio.

Integral antenna

Part number	Type (description)	Gain	Application
31000020-01	Integral antenna	-2.5 dBi	Fixed/Mobile

Dipole antennas

Part number	Type (description)	Gain	Application
A24-HASM-450	Dipole (Half-wave articulated RPSMA-4.5")	2.1 dBi	Fixed/Mobile
A24-HABUF-P5I	Dipole (Half-wave bulkhead mount U.FL w/ 5" pigtail)	2.0 dBi	Fixed/Mobile
A24-HASM-525	Dipole (Half-wave articulated RPSMA-5.25")	2.0 dBi	Fixed/Mobile

Flex PCB antennas

Part number	Type (description)	Gain	Application
FXP74.07.0100A	Flexible PCB, U.FL w/ 100mm pigtail	4.0 dBi	Fixed/Mobile

Cellular antennas

Antenna gain must be below:

Frequency band	Gain
Band 2 (1900 MHz)	9.70 dBi
Band 4 (1700 MHz)	6.00 dBi
Band 12 (700 MHz)	9.01 dBi

Bande de fréquence	Gain
Band 2 (1900 MHz)	9.70 dBi
Band 4 (1700 MHz)	6.00 dBi
Band 12 (700 MHz)	9.01 dBi

Labeling requirements for the host device

The device shall be properly labeled to identify the product within the host device. The certification labels of the module shall be clearly visible at all times when installed in the host device, otherwise the host device must be labeled to display the FCC ID and IC of the module, preceded by the words "Contains transmitter module", or the word "Contains", or similar wording expressing the same meaning, as follows:

- Contains FCC ID: MCQ-XB3C1
- Contains IC: 1846A-XB3C1
- Contains FCC ID:RI7XE866A1NA
- Contains IC: 5131A-XE866A1NA

L'appareil hôte doit être étiqueté comme il faut pour permettre l'identification des modules qui s'y trouvent. L'étiquettes de certification du module donné doit être posée sur l'appareil hôte à un endroit bien en vue en tout temps. En l'absence d'étiquette, l'appareil hôte doit porter une étiquette donnant le FCC ID et le IC du module, précédé des mots « Contient un module d'émission », du mot « Contient » ou d'une formulation similaire exprimant le même sens, comme suit:

- Contains FCC ID: MCQ-XB3C1
- Contains IC: 1846A-XB3C1
- Contains FCC ID:RI7XE866A1NA
- Contains IC: 5131A-XE866A1NA

This Class B digital apparatus complies with Canadian ICES-003.

Cet appareil numérique de classe B est conforme à la norme canadienne ICES-003.