



# Digi XBee<sup>®</sup> Cellular LTE Cat 1

Embedded Modem

---

User Guide

## Revision history—90001525

---

Revision	Date	Description
A	September 2016	Baseline release of the document.
B	December 2016	Added API functionality. Many changes to reflect the initial production release.
C	February 2017	Added sleep support. Added SMS encoding information. Added <b>D6, D7, DV, AM, LA, SH, SL, SM, SP, ST</b> and <b>P1</b> commands. Noted that <b>AN</b> is not case-sensitive.
D	May 2017	Added 0x24 status to the <b>AI</b> command. Added many AT commands. Added sections on Getting started with MQTT and MicroPython. Updated the Device Cloud section to reflect the change to Digi Remote Manager. Updated the destination address in <b>Perform a (GET) HTTP request</b> . Added Verizon certification information.

## Trademarks and copyright

Digi, Digi International, and the Digi logo are trademarks or registered trademarks in the United States and other countries worldwide. All other trademarks mentioned in this document are the property of their respective owners.

© 2017 Digi International Inc. All rights reserved.

## Disclaimers

Information in this document is subject to change without notice and does not represent a commitment on the part of Digi International. Digi provides this document “as is,” without warranty of any kind, expressed or implied, including, but not limited to, the implied warranties of fitness or merchantability for a particular purpose. Digi may make improvements and/or changes in this manual or in the product(s) and/or the program(s) described in this manual at any time.

## Warranty

To view product warranty information, go to the following website:

[www.digi.com/howtobuy/terms](http://www.digi.com/howtobuy/terms)

## Send comments

**Documentation feedback:** To provide feedback on this document, send your comments to [techcomm@digi.com](mailto:techcomm@digi.com).

## Customer support

**Digi Technical Support:** Digi offers multiple technical support plans and service packages to help our customers get the most out of their Digi product. For information on Technical Support plans and pricing, contact us at +1 952.912.3444 or visit us at [www.digi.com/support](http://www.digi.com/support).

# Contents

---

## Digi XBee Cellular LTE Cat 1 Embedded Modem User Guide

Applicable firmware and hardware .....	9
Purchase the correct SIM cards .....	9

## Getting started with the XBee Cellular Modem Development Kit

Identify the kit contents .....	12
Cellular service .....	12
Connect the hardware .....	13
Configure the device using XCTU .....	14
Add a device .....	14
Update to the latest firmware .....	14
Software libraries .....	15
XBIB-U-DEV reference .....	16
Check for cellular registration and connection .....	18
Flow control .....	18
Send an SMS message to a phone .....	19
Connect to the ELIZA server .....	21
Connect to the echo server .....	23
Connect to the Daytime server .....	25
Connect to a TCP/IP address .....	27
Perform a (GET) HTTP request .....	29
Get started with MQTT .....	30
Example: MQTT connect .....	30
Send a connect packet .....	32
Example: send messages (publish) with MQTT .....	34
Example: receive messages (subscribe) with MQTT .....	34
Use MQTT over the XBee Cellular Modem with a PC .....	35
Get started with CoAP .....	39
CoAP terms .....	39
CoAP quick start example .....	39
Configure the device .....	40
Example: manually perform a CoAP request .....	41
Example: use Python to generate a CoAP message .....	41
Configure the XBee Cellular Modem using Digi Remote Manager .....	44
Create a Remote Manager account .....	44
Get the XBee Cellular Modem IMEI number .....	44
Add a XBee Cellular Modem to Remote Manager .....	44
Update the firmware .....	45

## Get started with MicroPython

About MicroPython .....	47
Why use MicroPython .....	47
MicroPython on the XBee Cellular Modem .....	47
Use XCTU to enter the MicroPython environment .....	47
Use the MicroPython Terminal in XCTU .....	48
Example: hello world .....	48
Example: turn on an LED .....	48
Example: code a request help button .....	49
Enter MicroPython paste mode .....	50
Catch a button press .....	50
Send a text (SMS) when the button is pressed .....	52
Add the time the button was pressed .....	53
Exit MicroPython mode .....	54
Other terminal programs .....	54
Tera Term for Windows .....	54
Use picocom in Linux .....	55

## Technical specifications

Interface and hardware specifications .....	58
RF characteristics .....	58
Networking specifications .....	58
Power requirements .....	58
Power consumption .....	59
Electrical specifications .....	59
Regulatory approvals .....	60

## Hardware

Mechanical drawings .....	62
Pin signals .....	62
Pin connection recommendations .....	63
Antenna connections .....	63
Antenna placement .....	64
SIM card .....	64
The Associate LED .....	64
Heat considerations .....	65
Add a fan to provide active cooling .....	65
Heat sink considerations .....	66
Power supply considerations .....	66
Add a capacitor to the RESET line .....	67

## Cellular connection process

Connecting .....	69
Cellular network .....	69
Data network connection .....	69
Data communication with remote servers (TCP/UDP) .....	69
Disconnecting .....	69
SMS encoding .....	70

## Modes

Select an operating mode .....	72
Transparent operating mode .....	72
API operating mode .....	73
Bypass operating mode .....	73
Enter Bypass operating mode .....	73
Leave Bypass operating mode .....	73
Boot the XBee Cellular Modem in Bypass operating mode .....	74
Restore cellular settings to default in Bypass operating mode .....	74
Command mode .....	74
Enter Command mode .....	74
Send AT commands .....	75
Apply command changes .....	75
Make command changes permanent .....	75
Exit Command mode .....	76

## Sleep modes

About sleep modes .....	78
Normal mode .....	78
Pin sleep mode .....	78
Cyclic sleep mode .....	78
Cyclic sleep with pin wake up mode .....	78
Airplane mode .....	78
The sleep timer .....	78
MicroPython sleep behavior .....	79

## Serial communication

Serial buffers .....	81
CTS flow control .....	81
RTS flow control .....	81

## AT commands

MicroPython commands .....	83
PS (Python Startup) .....	83
PY (MicroPython Command) .....	83
Special commands .....	84
AC (Apply Changes) .....	84
FR (Force Reset) .....	84
RE (Restore Defaults) .....	84
WR (Write) .....	85
Cellular commands .....	85
PH (Phone Number) .....	85
S# (ICCID) .....	85
IM (IMEI) .....	86
MN (Operator) .....	86
MV (Modem Firmware Version) .....	86
DB (Cellular Signal Strength) .....	86
AM (Airplane Mode) .....	86
DV (Antenna Diversity) .....	87

Network commands .....	87
IP (IP Protocol) .....	87
TL (SSL/TLS Protocol Version) .....	88
TM (TCP Client Connection Timeout) .....	88
DO (Device Options) .....	88
EQ (Device Cloud FQDN) .....	89
Addressing commands .....	89
SH (Serial Number High) .....	89
SL (Serial Number Low) .....	89
DL (Destination Address) .....	89
P# (Destination Phone Number) .....	90
DE (Destination Port) .....	90
TD (Text Delimiter) .....	90
MY (Module IP Address) .....	90
LA (Lookup IP Address of FQDN) .....	91
OD (Operating Destination Address) .....	91
C0 (Source Port) .....	91
Serial interfacing commands .....	92
BD (Baud Rate) .....	92
NB (Parity) .....	92
SB (Stop Bits) .....	93
RO (Packetization Timeout) .....	93
FT (Flow Control Threshold) .....	93
AP (API Enable) .....	94
I/O settings commands .....	94
D0 (DIO0/AD0) .....	94
D1 (DIO1/AD1) .....	95
D2 (DIO2/AD2) .....	95
D3 (DIO3/AD3) .....	95
D4 (DIO4) .....	96
D5 (DIO5/ASSOCIATED_INDICATOR) .....	96
D8 (DIO8/SLEEP_REQUEST) .....	97
D9 (DIO9/ON_SLEEP) .....	98
P0 (DIO10 Configuration) .....	98
P1 (DIO11/PWM1 Configuration) .....	98
P2 (DIO12 Configuration) .....	99
PD (Pull Direction) .....	99
PR (Pull-up/down Resistor Enable) .....	100
I/O sampling commands .....	101
TP (Temperature) .....	101
SM (Sleep Mode) .....	101
SP (Sleep Period) .....	101
ST (Wake Time) .....	102
Command mode options .....	102
CC (Command Sequence Character) .....	102
CT (Command Mode Timeout) .....	102
GT (Guard Times) .....	102
Firmware version/information commands .....	103
VR (Firmware Version) .....	103
VL (Version Long) .....	103
HV (Hardware Version) .....	103
AI (Association Indication) .....	103
HS (Hardware Series) .....	104
CK (Configuration CRC) .....	104
Diagnostic interface commands .....	104

DI (Device Cloud Indicator) .....	104
CI (Protocol/Connection Indication) .....	105
Execution commands .....	107
AN (APN) .....	107
NR (Network Reset) .....	108
!R (Modem Reset) .....	108
IS (Force Sample) .....	108

## Operate in API mode

API frame specifications .....	111
API operation (AP parameter = 1) .....	111
API operation-with escaped characters (AP parameter = 2) .....	111
Start delimiter .....	112
Length .....	112
Frame data .....	112
Checksum .....	113
Calculate and verify checksums .....	113
Frame descriptions .....	114
AT Command - 0x08 .....	114
AT Command: Queue Parameter Value - 0x09 .....	115
Transmit (TX) SMS - 0x1F .....	116
Transmit (TX) Request: IPv4 - 0x20 .....	117
AT Command Response - 0x88 .....	118
Transmit (TX) Status - 0x89 .....	119
Modem Status - 0x8A .....	120
Receive (RX) Packet: SMS - 0x9F .....	121
Receive (RX) Packet: IPv4 - 0xB0 .....	122

## Socket behavior

Secure Sockets Layer (SSL) certificate checking .....	124
Socket timeouts .....	124

## Troubleshooting

Cannot find the serial port for the device .....	126
Correct a macOS Java error .....	128
Unresponsive cellular component in Bypass mode .....	129
Not on expected network after APN change .....	130
Syntax error at line 1 .....	130
Error Failed to send SMS .....	130
Solution .....	130

## Certifications

Modification statement .....	132
Interference statement .....	132
Antenna specifications .....	132
FCC Class B digital device notice .....	133
Labelling requirements for the host device .....	133



# Digi XBee Cellular LTE Cat 1 Embedded Modem User Guide

---

The XBee Cellular Modem is an embedded Long-Term Evolution (LTE) Category 1 cellular module that provides original equipment manufacturers (OEMs) with a simple way to integrate cellular connectivity into their devices.

The XBee Cellular Modem enables OEMs to quickly integrate cutting edge 4G cellular technology into their devices and applications without dealing with the painful, time-consuming, and expensive FCC and carrier end-device certifications.

With the full suite of standard XBee API frames and AT commands, existing XBee customers can seamlessly transition to this new device with only minor software adjustments. When OEMs add the XBee Cellular Modem to their product, they create a future-proof design with flexibility to switch between wireless protocols or frequencies as needed.

## Applicable firmware and hardware

This manual supports the following firmware:

- 1005

It supports the following hardware:

- XBC-V1-UT-xxx

## Purchase the correct SIM cards

If you order the wrong type of SIM card it will not work with the XBee Cellular Modem.

Verizon recommends SIM SKU: **M2MTRI-NONRUG-GT-A** or an equivalent that must include a 4FF punch out. This SKU is in triple punch, so devices with 2FF/3FF or 4FF can use this SIM SKU.

Bulk SIMs for M2M/IoT are available from:

National distributor	Network	Contact	Phone number	Email
<a href="#">Reliance Communications</a>	Verizon direct	Raja Ali	917-517-7282	<a href="mailto:raja.ali@reliance.us">raja.ali@reliance.us</a>
<a href="#">Ingram Micro - Sales</a>	Verizon direct	Lesli Reeves	317-707-2371	<a href="mailto:lesli.reeves@ingrammicro.com">lesli.reeves@ingrammicro.com</a>

National distributor	Network	Contact	Phone number	Email
<a href="#">Ingram Micro - Sales</a>	Verizon direct	Steve Kreiger	317-707-2474	<a href="mailto:steve.kreiger@ingrammicro.com">steve.kreiger@ingrammicro.com</a>
<a href="#">Ice Mobility</a>	Verizon direct	Tom Puchala	847-876-1768	<a href="mailto:tom.puchala@icemobility.com">tom.puchala@icemobility.com</a>
<a href="#">KORE</a>	Verizon MVNO	Genesis Crowder	877-710-5673	<a href="mailto:gcrowder@korewireless.com">gcrowder@korewireless.com</a>
<a href="#">KORE</a>	Verizon MVNO	Mike Basso	877-710-5673	<a href="mailto:mbasso@korewireless.com">mbasso@korewireless.com</a>

The XBee Cellular Modem requires a 4FF (Nano) size SIM card. The SIM interface supports both 1.8 V and 3 V SIM types.

# Getting started with the XBee Cellular Modem Development Kit

---

This section describes how to connect the hardware in the XBee Cellular Modem Development Kit, and provides some examples you can use to communicate with the device.

Identify the kit contents .....	12
Cellular service .....	12
Connect the hardware .....	13
Configure the device using XCTU .....	14
Software libraries .....	15
XBIB-U-DEV reference .....	16
Check for cellular registration and connection .....	18
Flow control .....	18
Send an SMS message to a phone .....	19
Connect to the ELIZA server .....	21
Connect to the echo server .....	23
Connect to the Daytime server .....	25
Connect to a TCP/IP address .....	27
Perform a (GET) HTTP request .....	29
Get started with MQTT .....	30
Get started with CoAP .....	39
Configure the XBee Cellular Modem using Digi Remote Manager .....	44

## Identify the kit contents

The Developer's kit includes the following:

One XBIB-U-DEV board

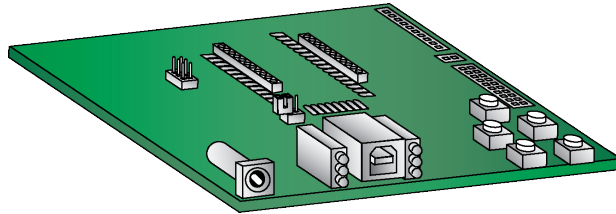

One 12 V power supply

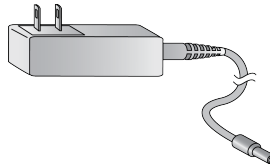

Two antennas with U.FL connectors

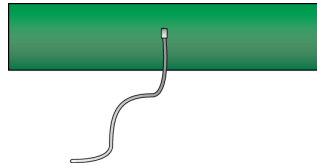

One USB cable

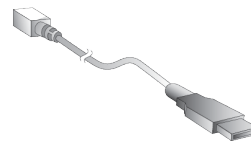

One XBee Cellular Modem

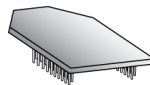

One SIM card



## Cellular service

The XBIB-U-DEV board comes in an anti-static bag. There is a label on the bag that provides the date that cellular service expires for the SIM card in the XBee Cellular Modem.

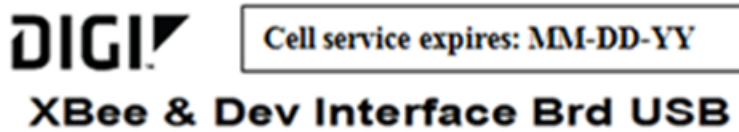

Note the expiration date and when cellular service expires, contact us at 1.877.890.4014 for further instructions on renewing cellular service for the device.

## Connect the hardware

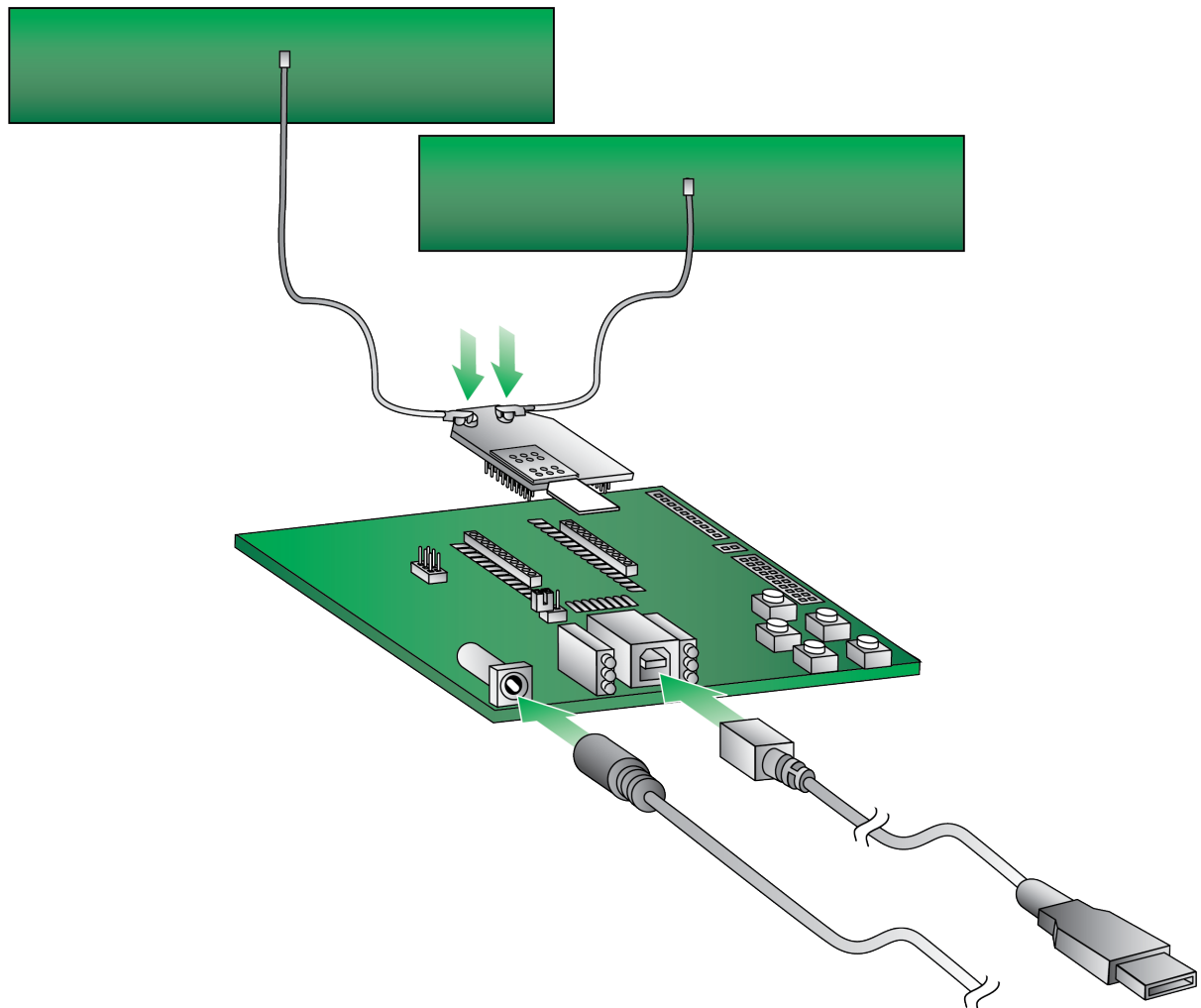

1. The XBee Cellular Modem should already be plugged into the XBIB-U-DEV board.
2. The SIM card should already be inserted into the XBee Cellular Modem. If not, install the SIM card into the XBee Cellular Modem.

---

**WARNING!** Never insert or remove the SIM card while the device is powered!



3. Connect the antennas to the XBee Cellular Modem by aligning the U.FL connectors carefully, then firmly pressing straight down to seat the connector. You should hear a snap when the antenna attaches correctly. U.FL is fragile and is not designed for multiple insertions, so exercise caution when connecting or removing the antennas. We recommend using a U.FL removal tool.
4. Plug the 12 V power supply to the power jack on the development board.

5. Connect the USB cable from a PC to the USB port on the development board. The computer searches for a driver, which can take a few minutes to install.

## Configure the device using XCTU

XBee Configuration and Test Utility (XCTU) is a multi-platform program that enables users to interact with Digi radio frequency (RF) devices through a graphical interface. The application includes built-in tools that make it easy to set up, configure, and test Digi RF devices.

For instructions on downloading and using XCTU, see [the XCTU User Guide](#).



---

**Note** If you are on a macOS computer and encounter problems installing XCTU, see [Correct a macOS Java error](#).

---

### Add a device



These instructions show you how to add the XBee Cellular Modem to XCTU. If XCTU does not find your serial port, see [Cannot find the serial port for the device](#).

1. Launch XCTU .
2. Click the **Discover radio modules** button .
3. In the **Discover radio devices** dialog, select the serial ports where you want to look for XBee modules, and click **Next**.
4. In the **Set port parameters** window, maintain the default values and click **Finish**.
5. As XCTU locates radio modules, they appear in the **Discovering radio modules** dialog box.

If your module could not be found, XCTU displays the **Could not find any radio module** dialog providing possible reasons why the module could not be added.

### Update to the latest firmware

Firmware is the program code stored in the device's persistent memory that provides the control program for the device. Use XCTU to update the firmware.

1. Click the **Configuration working modes** button .
2. Select a local or remote XBee module from the **Radio Modules** list.
3. Click the **Update firmware** button .

The **Update firmware** dialog displays the available and compatible firmware for the selected XBee module.

4. Select the product family of the XBee module, the function set, and the latest firmware version.
5. Click **Update**. A dialog displays update progress.

See [How to update the firmware of your modules](#) in the XCTU User Guide for more information.

## Software libraries

One way to communicate with the XBee device is by using a software library. The libraries available for use with the XBee Cellular Modem include:

- [XBee Java library](#)

The XBee Java Library is a Java API. The package includes the XBee library, its source code and a collection of samples that help you develop Java applications to communicate with your XBee devices.

## XBIB-U-DEV reference

This picture shows the XBee USB development board and the table that follows explains the callouts in the picture.

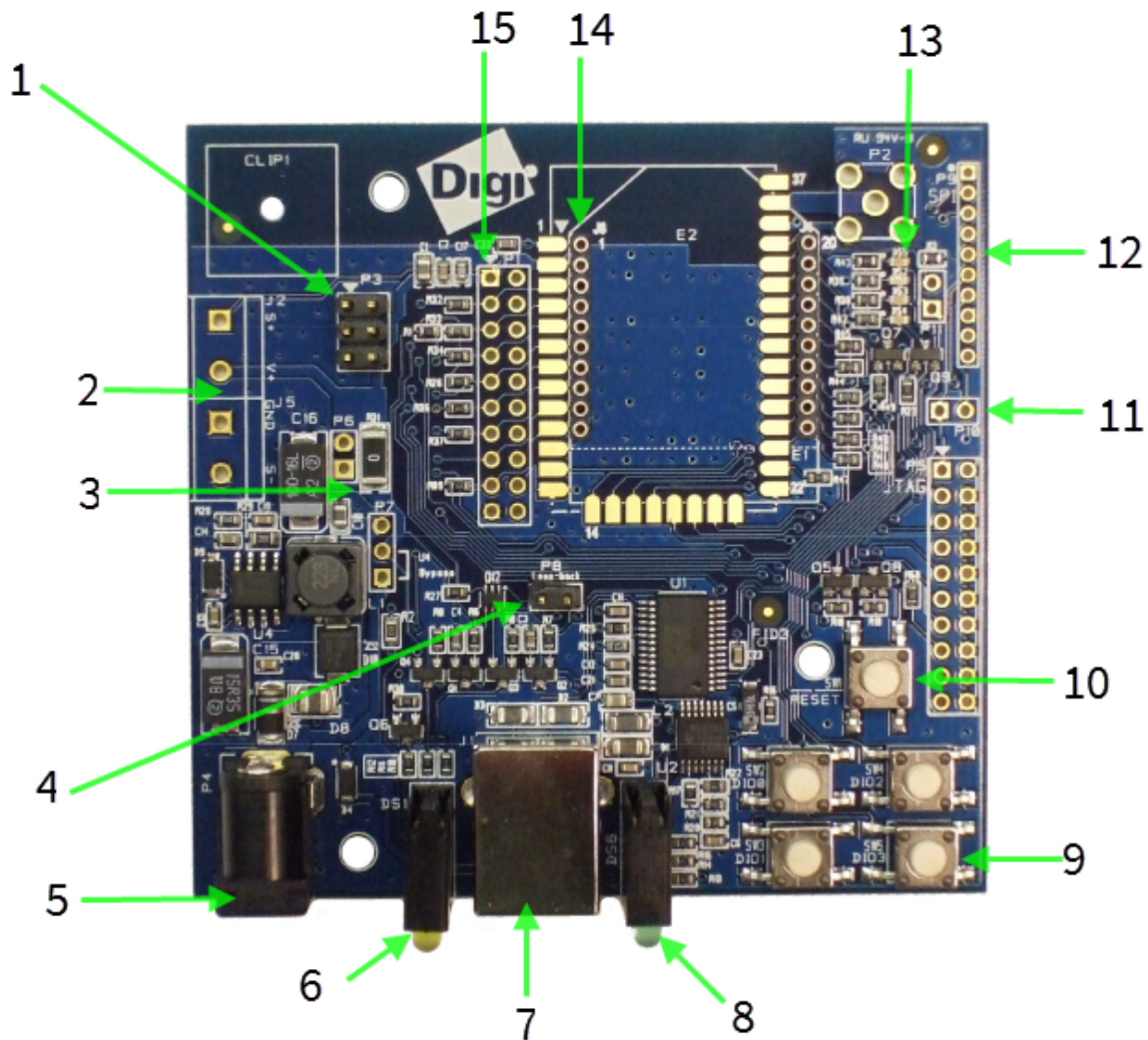

Number	Item	Description
1	Programming header	Header used to program XBee Programmable devices.



Number	Item	Description
2	Self power module	Advanced users only—voids the warranty. Depopulate R31 to power the device using V+ and GND from J2 and J5. You can connect sense lines to S+ and S- for sensing power supplies.   CAUTION: Voltage is not regulated. Applying the incorrect voltage can cause fire and serious injury. <sup>1</sup>
3	Current testing	Depopulating R31 allows a current probe to be inserted across P6 terminals. The current through P6/R31 powers the device only. Other supporting circuitry is powered by a different trace.
4	Loopback jumper	Populating P8 with a loopback jumper causes serial transmissions both from the device and from the USB to loopback.
5	DC barrel plug: 6-20 V	Greater than 500 mA loads require a DC supply for correct operation. Plug in the external power supply prior to the USB connector to ensure that proper USB communications are not interrupted.
6	LED indicator	Yellow: Modem sending serial/UART data to host. Green: Modem receiving serial/UART data from host. Red: Associate.
7	USB	
8	RSSI indicator	
9	User buttons	Connected to DIO lines for user implementation.
10	Reset button	
11	SPI power	Connect to the power board from 3.3 V.
12	SPI	Only used for surface-mount devices.
13	Indicator LEDs	DS5: ON/ <u>SLEEP</u> DS2: DIO12, the LED illuminates when driven low. DS3: DIO11, the LED illuminates when driven low. DS4: DIO4, the LED illuminates when driven low.
14	Through-hole XBee sockets	
15	20-pin header	Maps to standard through-hole XBee pins.

---

<sup>1</sup>Powering the board with J2 and J5 without R31 removed can cause shorts if the USB or barrel plug power are connected. Applying too high a voltage destroys electronic circuitry in the device and other board components and/or can cause injury.

## Check for cellular registration and connection

In the following examples, proper cellular network registration and address assignment must occur successfully. The LED on the development board blinks when the XBee Cellular Modem registers to the cellular network; see [The Associate LED](#). If the LED remains solid, registration has not occurred properly. Registration can take several minutes.

---

**Note** Make sure you are in an area with adequate cellular network reception or the XBee Cellular Modem will not make the connection.

---

In addition to the LED confirmation, you can check the AT commands below in XCTU to check the registration and connection. To view these commands:

1. Open XCTU and click the **Configuration working mode**  button.
2. Select a device from the **Radio Modules** list. XCTU displays the current firmware settings for that device.

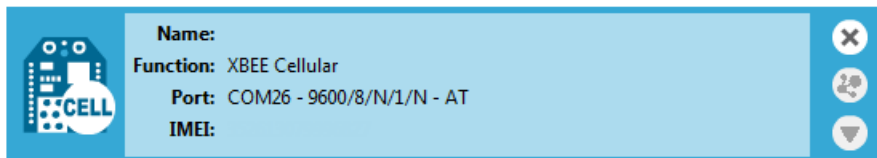

3. On the Configuration toolbar, click the **Default** button  to load the default values established by the firmware, and click **Yes** to confirm.

The relevant commands are:

---

**Note** To search for an AT command in XCTU, use [the search box](#).

---

- **AI** (Association Indication) reads zero when the device successfully registers to the cellular network. If it reads 0x23 it is connecting to the Internet; 0x22 means it is registering to the cellular network.
- **MY** (Module IP Address) should display a valid IP address. If it reads **0.0.0.0**, it has not registered yet.
- **AN** is not visible on the standard settings interface, it is an advanced command. See [AN \(APN\)](#).

## Flow control

We strongly encourage you to use flow control with the XBee Cellular Modem to prevent buffer overruns. See [Serial communication](#) for details on RTS and CTS flow control.

## Send an SMS message to a phone



The XBee Cellular Modem can send and receive Short Message Service (SMS) transmissions (texts) while in Transparent mode. This allows you to send and receive text messages to and from an SMS capable device such as a mobile phone.

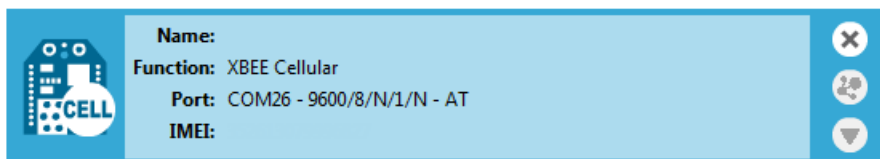

The following table explains the AT commands that you use in this example.

Command	Value	Description
<b>AP</b> (API Enable)	0	Set the device's API mode to Transparent mode.
<b>IP</b> (IP Protocol)	2	Set the expected transmission mode to SMS communication.
<b>P#</b> (Destination Phone Number)	<Target phone number>	The target phone number that you send to, for example, your cellular phone. See <a href="#">P# (Destination Phone Number)</a> for instructions on using this command.
<b>TD</b> (Text Delimiter)	D (0x0D)	The text delimiter to be used for Transparent mode, as an ASCII hex code. No information is sent until this character is entered, unless the maximum number of characters has been reached. Set to zero to disable text delimiter checking. Set to D for a carriage return.
<b>PH</b> (Module's SIM phone number)	Read only	The value that represents your device's phone number as supplied by the SIM card. This is used to send text messages to the device from another cellular device.

1. Ensure that the device is set up correctly with the SIM card installed and the antennas connected as described in [Connect the hardware](#).
2. Open XCTU and click the **Configuration working mode**  button.
3. Select a device from the **Radio Modules** list. XCTU displays the current firmware settings for that device.



4. On the Configuration toolbar, click the **Default** button  to load the default values established by the firmware, and click **Yes** to confirm.
5. Factory settings are loaded but not written to the device. To write them, click the **Write** button  on the toolbar.
6. To switch to SMS communication, in the **IP** field, select **2** and click the **Write** button .
7. To enter your cell phone number, in the **P#** field, type the **<target phone number>** and click the **Write** button. Type the phone number using only numbers, with no dashes. You can use the **+** prefix if necessary. The target phone number is the phone number you wish to send a text to.

8. In the **TD** field, type **D** and click the **Write** button.
9. Note the number in the **PH** field; it is the XBee Cellular Modem phone number, which you see when it sends an SMS to your phone.
10. Click the **Consoles working mode** button  on the toolbar to open a serial console to the device. For instructions on using the Console, see [http://www.digi.com/resources/documentation/digidocs/90001458-13/default.htm#reference/r\\_at\\_console.htm](http://www.digi.com/resources/documentation/digidocs/90001458-13/default.htm#reference/r_at_console.htm)
11. Click the **Open** button  to open a serial connection to the device.
12. Click in the left pane of the **Console log**, type **hello world** and press **Enter**. The XBee Cellular Modem sends the message to the destination phone number set by the **P#** command.
13. When the phone receives the text, you can see that the sender's phone number matches the value reported by the XBee Cellular Modem with the **PH** command.
14. On the phone, reply with the text **connect with confidence** and the XBee Cellular Modem outputs this reply from the UART.

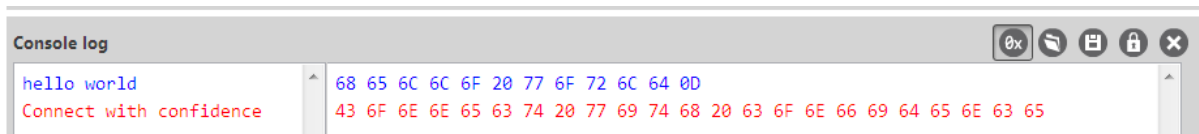

```
Console log
hello world      68 65 6C 6C 6F 20 77 6F 72 6C 64 0D
Connect with confidence 43 6F 6E 6E 65 63 74 20 77 69 74 68 20 63 6F 6E 66 69 64 65 6E 63 65
```

## Connect to the ELIZA server

You can use the XBee Cellular Modem to chat with the ELIZA Therapist Bot. ELIZA is an artificial intelligence (AI) bot that emulates a therapist and can perform simple conversations.





The following table explains the AT commands that you use in this example.

At command	Value	Description
<b>IP</b> (IP Protocol)	1	Set the expected transmission mode to TCP communications.
<b>DL</b> (Destination Address)	52.43.121.77	The target IP address of the Eliza server.
<b>DE</b> (Destination Port)	0x2328	The target port number of the Eliza server.

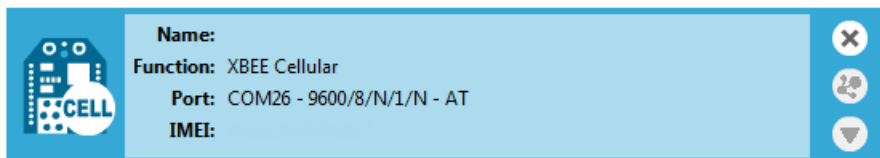
To communicate with the ELIZA Therapist Bot:

1. Ensure that the device is set up correctly with the SIM card installed and the antennas connected as described in [Connect the hardware](#).
2. Open XCTU and click the **Configuration working mode**  button.
3. Select a device from the **Radio Modules** list. XCTU displays the current firmware settings for that device.



4. On the Configuration toolbar, click the **Default** button  to load the default values established by the firmware, and click **Yes** to confirm.
5. Factory settings are loaded but not written to the device. To write them, click the **Write** button  on the toolbar.
6. To switch to TCP communication, in the **IP** field, select 1 and click the **Write** button .
7. To enter the destination address of the ELIZA Therapist Bot, in the **DL** field, type **52.43.121.77** and click the **Write** button.
8. To enter the destination IP port number, in the **DE** field, type **2328** and click the **Write** button.
9. Click the **Consoles working mode** button  on the toolbar to open a serial console to the device. For instructions on using the Console, see [http://www.digi.com/resources/documentation/digidocs/90001458-13/default.htm#reference/r\\_at\\_console.htm](http://www.digi.com/resources/documentation/digidocs/90001458-13/default.htm#reference/r_at_console.htm)
10. Click the **Open** button  to open a serial connection to the device.

11. Click in the left pane of the **Console log**, then type in the Console to talk to the ELIZA Therapist Bot. The following screenshot provides an example of this chat.

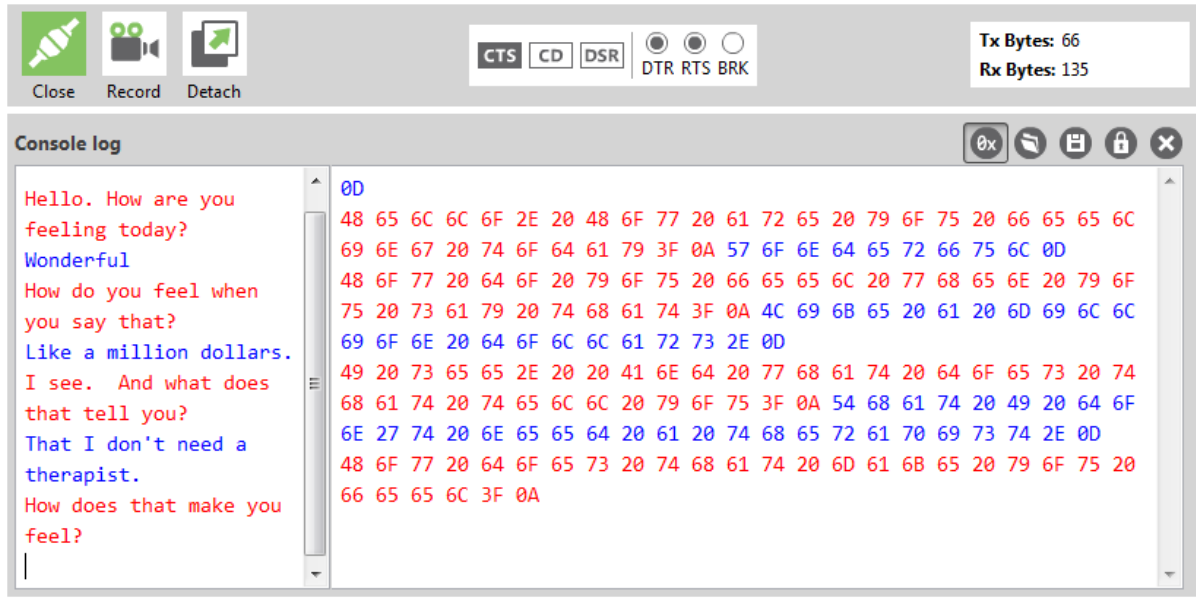

## Connect to the echo server

This server echoes back the messages you type.



The following table explains the AT commands that you use in this example.

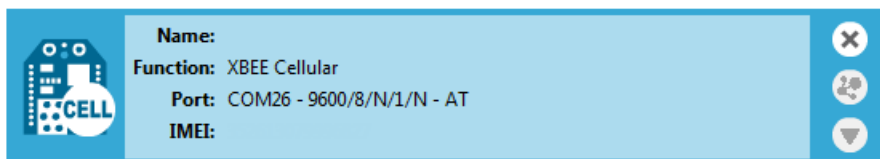

At command	Value	Description
<b>IP</b> (IP Protocol)	1	Set the expected transmission mode to TCP communications.
<b>TD</b> (Text Delimiter)	D (0x0D)	The text delimiter to be used for Transparent mode, as an ASCII hex code. No information is sent until this character is entered, unless the maximum number of characters has been reached. Set to zero to disable text delimiter checking. Set to <b>D</b> for a carriage return.
<b>DL</b> (Destination Address)	52.43.121.77	The target IP address of the echo server.
<b>DE</b> (Destination Port)	0x2329	The target port number of the echo server.

To communicate with the echo server:

1. Ensure that the device is set up correctly with the SIM card installed and the antennas connected as described in [Connect the hardware](#).
2. Open XCTU and click the **Configuration working mode**  button.
3. Select a device from the **Radio Modules** list. XCTU displays the current firmware settings for that device.



4. On the Configuration toolbar, click the **Default** button  to load the default values established by the firmware, and click **Yes** to confirm.
5. Factory settings are loaded but not written to the device. To write them, click the **Write** button  on the toolbar.
6. To switch to TCP communication, in the **IP** field, select 1 and click the **Write** button .
7. To enable the XBee Cellular Modem to recognize carriage return as a message delimiter, in the **TD** field, type **D** and click the **Write** button.

8. To enter the destination address of the echo server, in the **DL** field, type **52.43.121.77** and click the **Write** button.
9. To enter the destination IP port number, in the **DE** field, type **2329** and click the **Write** button.
10. Click the **Consoles working mode** button  on the toolbar to open a serial console to the device. For instructions on using the Console, see [http://www.digi.com/resources/documentation/digidocs/90001458-13/default.htm#reference/r\\_at\\_console.htm](http://www.digi.com/resources/documentation/digidocs/90001458-13/default.htm#reference/r_at_console.htm)
11. Click the **Open** button  to open a serial connection to the device.
12. Click in the left pane of the **Console log**, then type in the Console to talk to the echo server. The following screenshot provides an example of this chat.

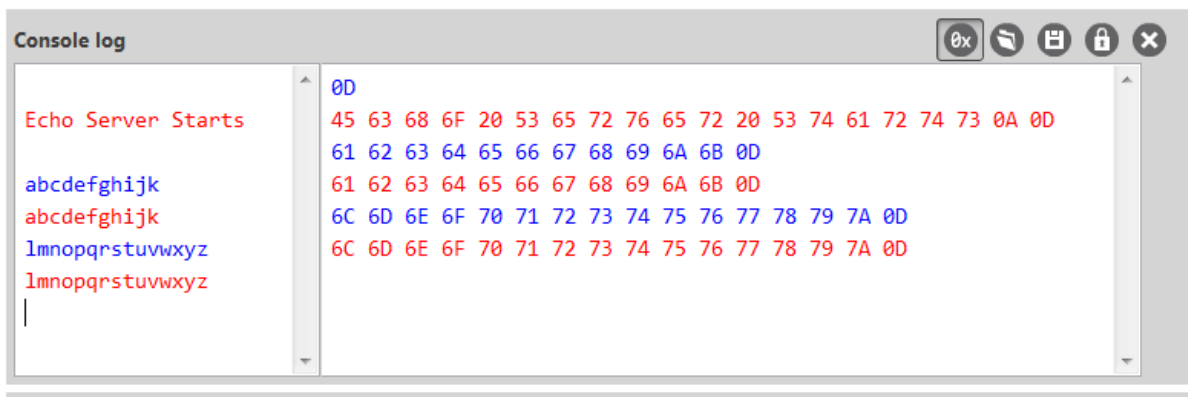



## Connect to the Daytime server

The Daytime server reports the current Coordinated Universal Time (UTC) value responding to any user input.



The following table explains the AT commands that you use in this example.

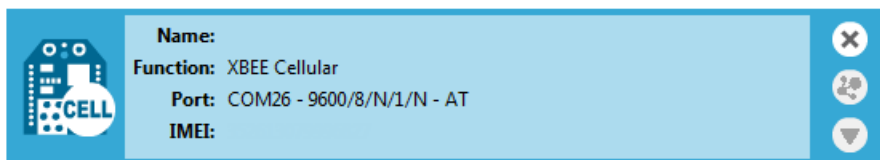

At command	Value	Description
<b>IP</b> (IP Protocol)	1	Set the expected transmission mode to TCP communications.
<b>DL</b> (Destination Address)	52.43.121.77	The target IP of the Daytime server.
<b>DE</b> (Destination Port)	0x232A	The target port number of the Daytime server.
<b>TD</b> (Text Delimiter)	0	The text delimiter to be used for Transparent mode, as an ASCII hex code. No information is sent until this character is entered, unless the maximum number of characters has been reached. Set to zero to disable text delimiter checking.

To communicate with the Daytime server:

1. Ensure that the device is set up correctly with the SIM card installed and the antennas connected as described in [Connect the hardware](#).
2. Open XCTU and click the **Configuration working mode**  button.
3. Select a device from the **Radio Modules** list. XCTU displays the current firmware settings for that device.



4. On the Configuration toolbar, click the **Default** button  to load the default values established by the firmware, and click **Yes** to confirm.
5. Factory settings are loaded but not written to the device. To write them, click the **Write** button  on the toolbar.
6. To switch to TCP communication, in the **IP** field, select 1 and click the **Write** button .
7. To enter the destination address of the daytime server, in the **DL** field, type **52.43.121.77** and click the **Write** button.
8. To enter the destination IP port number, in the **DE** field, type **232A** and click the **Write** button.

9. To disable text delimiter checking, in the **TD** field, type **0** and click the **Write** button.
10. Click the **Consoles working mode** button  on the toolbar to open a serial console to the device. For instructions on using the Console, see [http://www.digi.com/resources/documentation/digidocs/90001458-13/default.htm#reference/r\\_at\\_console.htm](http://www.digi.com/resources/documentation/digidocs/90001458-13/default.htm#reference/r_at_console.htm)
11. Click the **Open** button  to open a serial connection to the device.
12. Click in the left pane of the **Console log**, then type in the Console to query the Daytime server. The following screenshot provides an example of this chat.

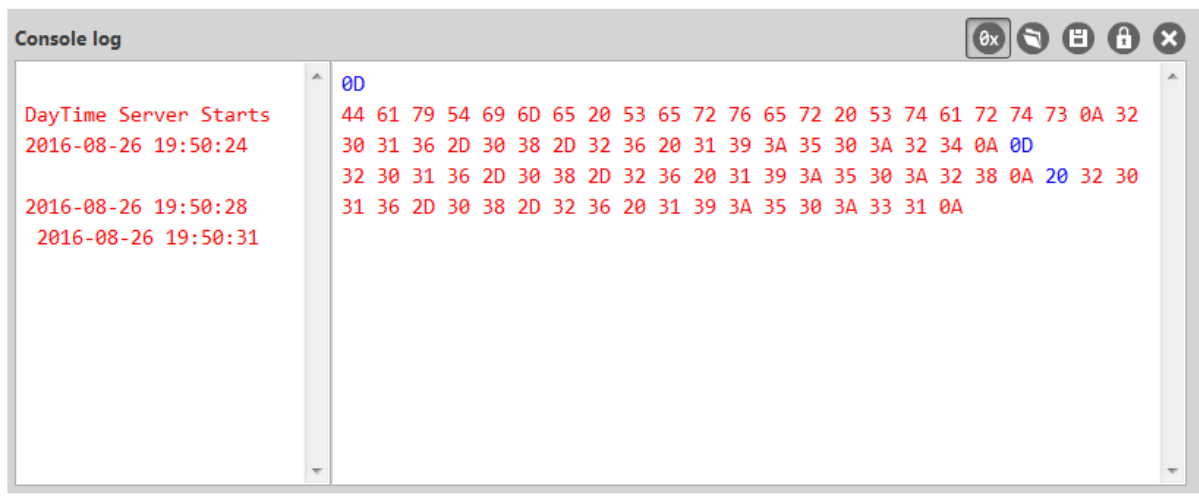

## Connect to a TCP/IP address

The XBee Cellular Modem can send and receive TCP messages while in Transparent mode; see [Transparent operating mode](#).



You can use this example as a template for sending and receiving data from a user. The following table explains the AT commands that you use in this example.

Command	Value	Description
<b>IP</b> (IP Protocol)	1	Set the expected transmission mode to TCP communication.
<b>DL</b> (Destination IP Address)	<Target IP address>	The target IP address that you send and receive from. For example, a data logging server's IP address that you want to send measurements to.
<b>DE</b> (Destination Port)	<Target port number>	The target port number that the device sends the transmission to. This is represented as a hexadecimal value.

To connect to a TCP/IP address:

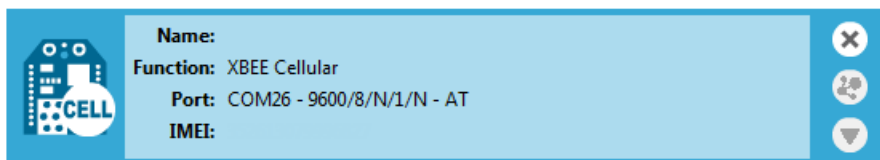
1. Ensure that the device is set up correctly with the SIM card installed and the antennas connected as described in [Connect the hardware](#).
2. Open XCTU and click the **Configuration working mode**  button.
3. Select a device from the **Radio Modules** list. XCTU displays the current firmware settings for that device.







4. On the Configuration toolbar, click the **Default** button  to load the default values established by the firmware, and click **Yes** to confirm.
5. Factory settings are loaded but not written to the device. To write them, click the **Write** button  on the toolbar.
6. In the **IP** field, select 1 and click the **Write** button .
7. In the **DL** field, type the <target IP address> and click the **Write** button. The target IP address is the IP address that you send and receive from.
8. In the **DE** field, type the <target port number>, converted to hexadecimal, and click the **Write** button.
9. Exit Command mode; see [Exit Command mode](#).

After exiting Command mode, any UART data sent to the device is sent to the destination IP address and port number after the **RO (Packetization Timeout)** occurs.

## Perform a (GET) HTTP request

You can use the XBee Cellular Modem to perform a GET Hypertext Transfer Protocol (HTTP) request using XCTU. This example uses <http://httpbin.org/> (IP address: 54.175.219.8) as the target website that responds to the HTTP request.

To perform a GET request:

1. Ensure that the device is set up correctly with the SIM card installed and the antennas connected as described in [Connect the hardware](#).
2. Open XCTU and click the **Configuration working mode**  button.
3. Select a device from the **Radio Modules** list. XCTU displays the current firmware settings for that device.
4. To enter the destination address of the target website, in the **DL** field, type **httpbin.org** and click the **Write** button .
5. To enter the HTTP request port number, in the **DE** field, type **50** and click the **Write** button. Hexadecimal **50** is 80 in decimal.
6. To switch to TCP communication, in the **IP** field, select **1** and click the **Write** button.
7. To move into Transparent mode, in the **AP** field, select **0** and click the **Write** button.
8. Wait for the **AI** (Association Indication) value to change to **0** (Connected to the Internet).
9. Click the **Consoles working mode** button  on the toolbar.
10. From the AT console, click the **Add new packet button**  in the Send packets dialog. The **Add new packet** dialog appears.
11. Enter the name of the data packet.
12. Type the following data in the **ASCII** input tab:  
GET /ip HTTP/1.1  
Host: httpbin.org
13. Click the **HEX** input tab and add **0A** (zero A) after each **0D** (zero D), and add an additional **0D 0A** at the end of the message body. For example, copy and past the following text into the **HEX** input tab:  
47 45 54 20 2F 69 70 20 48 54 54 50 2F 31 2E 31 0D 0A 48 6F 73 74 3A 20 68 74 74 70 62 69 6E 2E 6F 72 67 0D 0A 0D 0A

---

**Note** The HTTP protocol requires an empty line (a line with nothing preceding the CRLF) to terminate the request.

---

14. Click **Add packet**.
15. Click the **Open** button .
16. Click **Send selected packet**.
17. A GET HTTP response from httpbin.org appears in the Console log.

## Get started with MQTT

MQ Telemetry Transport (MQTT) is a messaging protocol that is ideal for the Internet of Things (IoT) due to a light footprint and its use of the publish-subscribe model. In this model, a client connects to a broker, a server machine responsible for receiving all messages, filtering them, and then sending messages to the appropriate clients.

The first two MQTT examples do not involve the XBee Cellular Modem. They demonstrate using the MQTT libraries because those libraries are required for [Use MQTT over the XBee Cellular Modem with a PC](#).

The examples in this guide assume:

- Some knowledge of Python.
- An integrated development environment (IDE) such as PyCharm, IDLE or something similar.

The examples require:

- An XBee Cellular Modem.
- A compatible development board, such as the XBIB-U.
- XCTU. See [Configure the device using XCTU](#).
- That you install Python on your computer. You can download Python from: <https://www.python.org/downloads/>.
- That you install the **pyserial** and **paho-mqtt** libraries to the Python environment. If you use Python 2, install these libraries from the command line with **pip install pyserial** and **pip install paho-mqtt**. If you use Python 3, use **pip3 install pyserial** and **pip3 install paho-mqtt**.
- The full MQTT library source code, which includes examples and tests, which is available in the paho-mqtt github repository at <https://github.com/eclipse/paho.mqtt.python>. To download this repository you must have Git installed.

### Example: MQTT connect

This example provides insight into the structure of packets in MQTT as well as the interaction between the client and broker. MQTT uses different packets to accomplish tasks such as connecting, subscribing, and publishing. You can use XCTU to perform a basic example of sending a broker a connect packet and receiving the response from the server, without requiring any coding. This is a good way to see how the client interacts with the broker and what a packet looks like. The following table is an example connect packet:

	Description	Hex value
CONNECT packet fixed header		
byte 1	Control packet type	0x10
byte 2	Remaining length	0x10
CONNECT packet variable header		
Protocol name		

	Description	Hex value
byte 1	Length MSB (0)	0x00
byte 2	Length LSB (4)	0x04
byte 3	(M)	0x4D
byte 4	(Q)	0x51
byte 5	(T)	0x54
byte 6	(T)	0x54
Protocol level		
byte 7	Level (4)	0x04
Connect flags		
byte 8	CONNECT flags byte, see the table below for the bits.	0X02
Keep alive		
byte 9	Keep Alive MSB (0)	0X00
byte 10	Keep Alive LSB (60)	0X3C
Client ID		
byte 11	Length MSB (0)	0x00
byte 12	Length LSB (4)	0x04
byte 13	(D)	0x44
byte 14	(I)	0x49
byte 15	(G)	0x47
byte 16	(I)	0x49

The following table describes the fields in the packet:

Field name	Description
Protocol Name	The connect packet starts with the protocol name, which is MQTT. The length of the protocol name (in bytes) is immediately before the name itself.
Protocol Level	Refers to the version of MQTT in use, in this case a value of 4 indicates MQTT version 3.1.1.
Connect Flags	Indicate certain aspects of the packet. For simplicity, this example only sets the Clean Session flag, which indicates to the client and broker to discard any previous session and start a new one.
Keep Alive	How often the client pings the broker to keep the connection alive; in this example it is set to 60 seconds.

Field name	Description
Client ID	The length of the ID (in bytes) precedes the ID itself. Each client connecting to a broker must have a unique client ID. In the example, the ID is DIGI. When using the Paho MQTT Python libraries, a random alphanumeric ID is generated if you do not specify an ID.

The following table provides the CONNECT flag bits from byte 8, the CONNECT flags byte.

CONNECT Flag Bit(s)	Bit 7	Bit 6	Bit 5	Bit 4	Bit 3	Bit 2	Bit 1	Bit 0
User name flag	0							
Password flag		0						
Will retain			0					
Will QoS				0	0			
Will flag						0		
Clean session							1	
Reserved								0

## Send a connect packet

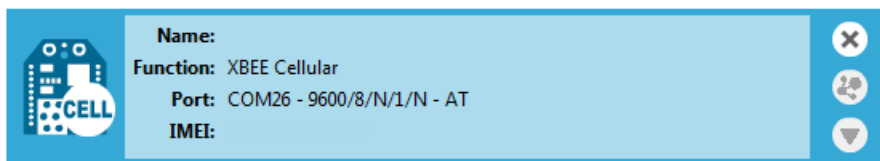

Now that you know what a connect packet looks like, you can send a connect packet to a broker and view the response. Open XCTU and click the Configuration working mode button.

1. Ensure that the device is set up correctly with the SIM card installed and the antennas connected as described in [Connect the hardware](#).
2. Open XCTU and click the **Configuration working mode**  button.
3. Add the XBee Cellular Modem to XCTU; see [Add a device](#).
4. Select a device from the **Radio Modules** list. XCTU displays the current firmware settings for that device.



5. In the **AP** field, set **Transparent Mode** to **[0]** if it is not already and click the **Write** button.
6. In the **DL** field, type the IP address of the broker you wish to use. This example uses **198.41.30.241**, which is the IP address for [m2m.eclipse.org](http://m2m.eclipse.org), a public MQTT broker.
7. In the **DE** field, type **75B** and set the port that the broker uses. This example uses **75B**, because the default MQTT port is 1883 (0x75B).
8. Once you have entered the required values, click the **Write** button to write the changes to the XBee Cellular Modem.



9. Click the **Consoles working mode** button  on the toolbar to open a serial console to the device. For instructions on using the Console, see [http://www.digi.com/resources/documentation/digidocs/90001458-13/default.htm#reference/r\\_at\\_console.htm](http://www.digi.com/resources/documentation/digidocs/90001458-13/default.htm#reference/r_at_console.htm)
10. Click the **Open** button  to open a serial connection to the device.
11. From the AT console, click the **Add new packet button**  in the Send packets dialog. The **Add new packet** dialog appears.
12. Enter the name of the data packet. Name the packet **connect\_frame** or something similar.
13. Click the **HEX** input tab and type the following (these values are the same values from the table in [Example: MQTT connect](#)):

**10 10 00 04 4D 51 54 54 04 02 00 3C 00 04 44 49 47 49**

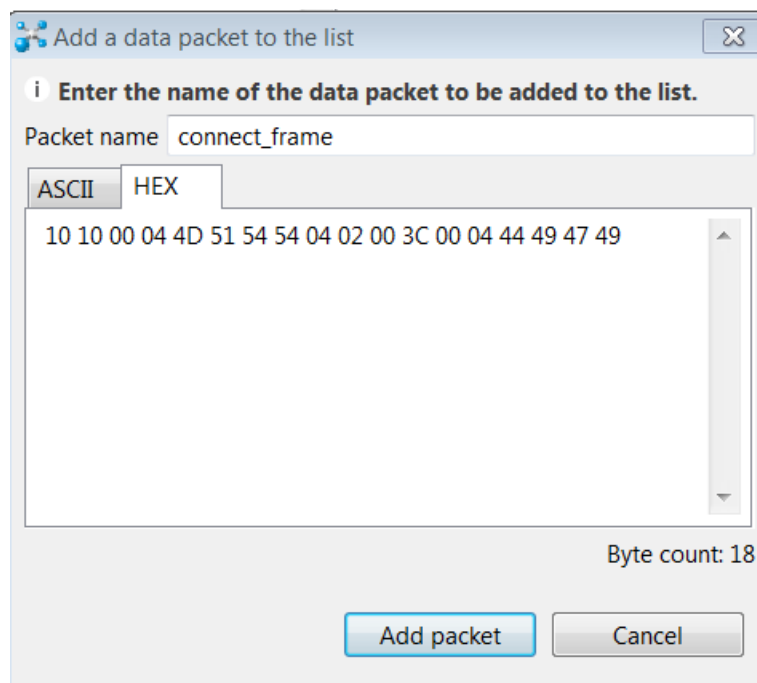

14. Click **Add packet**. The new packet appears in the Send packets list.
15. Click the packet in the **Send packets** list.
16. Click **Send selected packet**.
17. A CONNACK packet response from the broker appears in the **Console log**. This is a connection acknowledgment; a successful response should look like this:

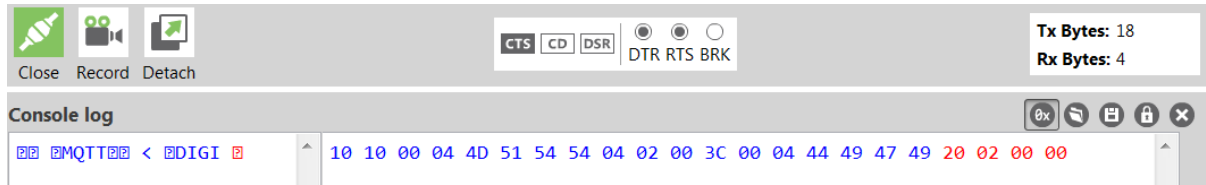

You can verify the response from the broker as a CONNACK by comparing it to the structure of a CONNACK packet in the MQTT documentation, which is available at [http://docs.oasis-open.org/mqtt/mqtt/v3.1.1/os/mqtt-v3.1.1-os.html#\\_Toc398718081](http://docs.oasis-open.org/mqtt/mqtt/v3.1.1/os/mqtt-v3.1.1-os.html#_Toc398718081).

## Example: send messages (publish) with MQTT

A basic Python example of a node publishing (sending) a message is:

```
mqttc = mqtt.Client("digitest") # Create instance of client with client ID
"digitest"
mqttc.connect("m2m.eclipse.org", 1883) # Connect to (broker, port,
keepalive-time)
mqttc.loop_start() # Start networking daemon
mqttc.publish("digitest/test1", "Hello, World!") # Publish message to
"digitest /test1" topic
mqttc.loop_stop() # Kill networking daemon
```

Do not copy code from the PDF and paste it into a MicroPython terminal, as any blank spaces at the beginning of a line of code are ignored. You can copy code correctly from the HTML version of the document.

You can download this .py file [here](#).

This example imports the MQTT library, allowing you to use the MQTT protocol via APIs in the library, such as the **connect()**, **subscribe()**, and **publish()** methods.

The second line creates an instance of the client, named **mqttc**. The client ID is the argument you passed in: **digitest** (this is optional).

In line 3, the client connects to a public broker, in this case **m2m.eclipse.org**, on port **1883** (the default MQTT port, or 8883 for MQTT over SSL). There are many publicly available brokers available, you can find a list of them here: <https://github.com/mqtt/mqtt.github.io/wiki/brokers>.

Line 4 starts the networking daemon with **client.loop\_start()** to handle the background network/data tasks.

Finally, the client publishes its message **Hello, World!** to the broker under the topic **digitest/backlog/test1**. Any nodes (devices, phones, computers, even microcontrollers) subscribed to that same topic on the same broker receive the message.

Once no more messages need to be published, the last line stops the network daemon with **client.loop\_stop()**.

## Example: receive messages (subscribe) with MQTT

This example describes how a client would receive messages from within a specific topic on the broker:

```
import paho.mqtt.client as mqtt

def on_connect(client, userdata, flags, rc): # The callback for when the
client connects to the broker
```

---

```

    print("Connected with result code {}".format(str(rc))) # Print result
of connection attempt
    client.subscribe("digitest/test1") # Subscribe to the topic
"digitest/test1", receive any messages published on it

def on_message(client, userdata, msg): # The callback for when a PUBLISH
message is received from the server.
    print("Message received-> " + msg.topic + " " + str(msg.payload)) #
Print a received msg

client = mqtt.Client("digi_mqtt_test") # Create instance of client with
client ID "digi_mqtt_test"
client.on_connect = on_connect # Define callback function for successful
connection
client.on_message = on_message # Define callback function for receipt of a
message
# client.connect("m2m.eclipse.org", 1883, 60) # Connect to (broker, port,
keepalive-time)
client.connect('127.0.0.1', 17300)
client.loop_forever() # Start networking daemon

```

---

Do not copy code from the PDF and paste it into a MicroPython terminal, as any blank spaces at the beginning of a line of code are ignored. You can copy code correctly from the HTML version of the document.

The first line imports the library functions for MQTT.

The functions **on\_connect** and **on\_message** are callback functions which are automatically called by the client upon connection to the broker and upon receiving a message, respectively.

The **on\_connect** function prints the result of the connection attempt, and performs the subscription. It is wise to do this in the callback function as it guarantees the attempt to subscribe happens only after the client is connected to the broker.

The **on\_message** function prints the received message when it comes in, as well as the topic it was published under.

In the body of the code, we:

- Instantiate a client object with the client ID **digi\_mqtt\_test**
- Define the callback functions to use upon connection and upon message receipt
- Connect to an MQTT broker at **m2m.eclipse.org**, on port **1883** (the default MQTT port, or 8883 for MQTT over SSL) with a keepalive of 60 seconds (this is how often the client pings the broker to keep the connection alive).

The last line starts a network daemon that runs in the background and handles data transactions and messages, as well as keeping the socket open, until the script ends.

## Use MQTT over the XBee Cellular Modem with a PC

To use this MQTT library over an XBee Cellular Modem, you need a basic proxy that transfers a payload received via the MQTT client's socket to the serial or COM port that the XBee Cellular Modem is active on, as well as the reverse; transfer of a payload received on the XBee Cellular Modem's serial or COM port to the socket of the MQTT client. This is simplest with the XBee Cellular Modem in Transparent mode, as it does not require code to parse or create API frames, and not using API frames means there is no need for them to be queued for processing.

1. To put the XBee Cellular Modem in Transparent mode, set **AP** to **0**.
2. Set **DL** to the IP address of the broker you want to use.
3. Set **DE** to the port to use, the default is 1883 (0x75B). This sets the XBee Cellular Modem to communicate directly with the broker, and can be performed in XCTU as described in [Example: MQTT connect](#).
4. You can make the proxy with a dual-threaded Python script, a simple version follows:

---

```
import threading
import serial
import socket

def setup():
    """
    This function sets up the variables needed, including the serial port,
    and it's speed/port settings, listening socket, and localhost address.
    """
    global clisock, cliaddr, svrsock, ser
    # Change this to the COM port your XBee Cellular module is using. On
    # Linux, this will be /dev/ttyUSB#
    comport = 'COM44'
    # This is the default serial communication speed of the XBee Cellular
    # module
    comspeed = 115200
    buffer_size = 4096 # Default receive size in bytes
    debug_on = 0 # Enables printing of debug messages
    toval = None # Timeout value for serial port below
    # Serial port object for XBCell modem
    ser = serial.Serial(comport,comspeed,timeout=toval)
    # Listening socket (accepts incoming connection)
    svrsock = socket.socket(socket.AF_INET,socket.SOCK_STREAM)
    # Allow address reuse on socket (eliminates some restart errors)
    svrsock.setsockopt(socket.SOL_SOCKET, socket.SO_REUSEADDR, 1)
    clisock = None
    cliaddr = None # These are first defined before thread creation
    addrtuple = ('127.0.0.1', 17300) # Address tuple for localhost
    # Binds server socket to localhost (allows client program connection)
    svrsock.bind(addrtuple)
    svrsock.listen(1) # Allow (1) connection

def ComReaderThread():
    """
    This thread listens on the defined serial port object ('ser') for data
    from the modem, and upon receipt, sends it out to the client over the
    client socket ('clisock').
    """
    global clisock
    while (1):
        resp = ser.read() ## Read any available data from serial port
        print("Received {} bytes from modem.".format(len(resp)))

        clisock.sendall(resp) # Send RXd data out on client socket
        print("Sent {} byte payload out socket to client.".format(len
(resp)))
```

---

---

```

def SockReaderThread():
    """
    This thread listens to the MQTT client's socket and upon receiving a
    payload, it sends this data out on the defined serial port ('ser') to
    the
    modem for transmission.
    """

    global clisock
    while (1):
        data = clisock.recv(4096) # RX data from client socket
        # If the RECV call returns 0 bytes, the socket has closed
        if (len(data) == 0):
            print("ERROR - socket has closed. Exiting socket reader
thread.")
            return 1 # Exit the thread to avoid a loop of 0-byte receptions
        else:
            print("Received {} bytes from client via socket.".format(len
(data)))
            print("Sending payload to modem...")
            bytes_wr = ser.write(data) # Write payload to modem via
UART/serial
            print("Wrote {} bytes to modem".format(bytes_wr))

def main():
    setup() # Setup the serial port and socket
    global clisock, svrsock
    if (not clisock): # Accept a connection on 'svrsock' to open 'clisock'
        print("Awaiting ACCEPT on server sock...")
        (clisock, cliaddr) = svrsock.accept() # Accept an incoming
connection
        print("Connection accepted on socket")
        # Make thread for ComReader
        comthread = threading.Thread(target=ComReaderThread)
        comthread.start() # Start the thread
        # Make thread for SockReader
        sockthread = threading.Thread(target=SockReaderThread)
        sockthread.start() # Start the thread

main()

```

---

**Note** This script is a general TCP-UART proxy, and can be used for other applications or scripts that use the TCP protocol. Its functionality is not limited to MQTT.

---

Do not copy code from the PDF and paste it into a MicroPython terminal, as any blank spaces at the beginning of a line of code are ignored. You can copy code correctly from the HTML version of the document.

This proxy script waits for an incoming connection on localhost (**127.0.0.1**), on port **17300**. After accepting a connection, and creating a socket for that connection (**clisock**), it creates two threads, one that reads the serial or COM port that the XBee Cellular Modem is connected to, and one that reads the socket (**clisock**), that the MQTT client is connected to.

With:

- The proxy script running
- The MQTT client connected to the proxy script via localhost (**127.0.0.1**)

- The XBee Cellular Modem connected to the machine via USB and properly powered
- **AP**, **DL**, and **DE** set correctly

the proxy acts as an intermediary between the MQTT client and the XBee Cellular Modem, allowing the MQTT client to use the data connection provided by the device.

Think of the proxy script as a translator between the MQTT client and the XBee Cellular Modem. The following figure shows the basic operation.

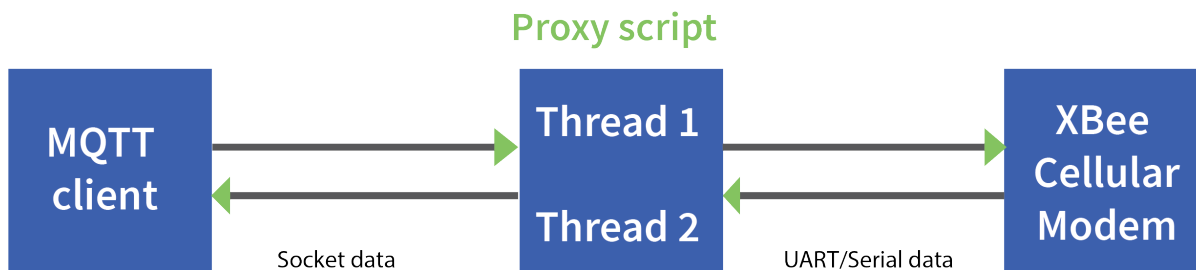

The thread that reads the serial port forwards any data received onward to the client socket, and the thread reading the client socket forwards any data received onward to the serial port. This is represented in the figure above.

The proxy script needs to be running before running an MQTT publish or subscribe script.

1. With the proxy script running, run the subscribe example from [Example: receive messages \(subscribe\) with MQTT](#), but change the connect line from `client.connect("m2m.eclipse.org", 1883, 60)` to `client.connect("127.0.0.1", port=17300, keepalive=20)`. This connects the MQTT client to the proxy script, which in turn connects to a broker via the XBee Cellular Modem's internet connection.
2. Run the publish example from [Example: send messages \(publish\) with MQTT](#) in a third Python instance (while the publish script is running you will have three Python scripts running at the same time).

The publish script runs over your computer's normal internet connection, and does not use the XBee Cellular Modem. You are able to see your published message appear in the subscribe script's output once it is received from the broker via the XBee Cellular Modem. If you watch the output of the proxy script during this process you can see the receptions and transmissions taking place.

The proxy script must be running before you run the subscribe and publish scripts. If you stop the subscribe script, the socket closes, and the proxy script shows an error. If you try to start the proxy script after starting the subscribe script, you may also see a socket error. To avoid these errors, it is best to start the scripts in the correct order: proxy, then subscribe, then publish.

## Get started with CoAP

Constrained Application Protocol (CoAP) is based on UDP connection and consumes low power to deliver similar functionality to HTTP. This guide contains information about sending GET, POST, PUT and DELETE operations by using the Coap Protocol with XCTU and Python code working with the XBee Cellular Modem and Coapthon library (Python 2.7 only).

The Internet Engineering Task Force describes CoAP as:

The protocol is designed for machine-to-machine (M2M) applications such as smart energy and building automation. CoAP provides a request/response interaction model between application endpoints, supports built-in discovery of services and resources, and includes key concepts of the Web such as URIs and Internet media types. CoAP is designed to easily interface with HTTP for integration with the Web while meeting specialized requirements such as multicast support, very low overhead, and simplicity for constrained environments ([source](#)).

### CoAP terms

When describing CoAP, we use the following terms:

Term	Meaning
Method	COAP's method action is similar to the HTTP method. This guide discusses the GET, POST, PUT and DELETE methods. With these methods, the XBee Cellular Modem can transport data and requests.
URI	URI is a string of characters that identifies a resource served at the server.
Token	A token is an identifier of a message. The client uses the token to verify if the received message is the correct response to its query.
Payload	The message payload is associated with the POST and PUT methods. It specifies the data to be posted or put to the URI resource
Message ID	The message ID is also an identifier of a message. The client matches the message ID between the response and query.

### CoAP quick start example

The following diagram shows the message format for the CoAP protocol; see [ISSN: 2070-1721](#) for details:

```

0 1 2 3
0 1 2 3 4 5 6 7 8 9 0 1 2 3 4 5 6 7 8 9 0 1 2 3 4 5 6 7 8 9 0 1
+--+--+--+--+--+--+--+--+--+--+--+--+--+--+--+--+--+--+--+--+--+
|Ver| T | TKL | Code | Message ID |
+--+--+--+--+--+--+--+--+--+--+--+--+--+--+--+--+--+--+--+--+--+
| Token (if any, TKL bytes) ...
+--+--+--+--+--+--+--+--+--+--+--+--+--+--+--+--+--+--+--+--+--+
| Options (if any) ...
+--+--+--+--+--+--+--+--+--+--+--+--+--+--+--+--+--+--+--+--+--+
|1 1 1 1 1 1 1 1| Payload (if any) ...
+--+--+--+--+--+--+--+--+--+--+--+--+--+--+--+--+--+--+--+--+--+

```





This is an example GET request:

44 01 C4 09 74 65 73 74 B7 65 78 61 6D 70 6C 65

The following table describes the fields in the GET request.

Field	HEX	Bits	Meaning
Ver	44	01	Version 01, which is mandatory here.
T		00	Type 0: confirmable.
TKL		0100	Token length: 4.
Code	01	000 00001	Code: 0.01, which indicates the GET method.
Message ID	C4 09	2 Bytes equal to hex at left	Message ID. The response message will have the same ID. This can help out identification.
Token	74 65 73 74	4 Bytes equal to hex at left	Token. The response message will have the same token. This can help out identification.
Option delta	B7	1011	Delta option: 11 indicates the option data is Uri-Path.
Option length		0111	Delta length: 7 indicates there are 7 bytes of data following as a part of this delta option.
Option value	65 78 61 6D 70 6C 65	7 Bytes equal to hex at left	Example.



## Configure the device

1. Ensure that the device is set up correctly with the SIM card installed and the antennas connected as described in [Connect the hardware](#).
2. Open XCTU and click the **Configuration working mode**  button.
3. Add the XBee Cellular Modem to XCTU; see [Add a device](#).
4. Select a device from the **Radio Modules** list. XCTU displays the current firmware settings for that device.
5. To switch to UDP communication, in the **IP** field, select **0** and click the **Write** button .
6. To set the target IP address that the XBee Cellular Modem will talk to, in the **DL** field type **52.43.121.77** and click the **Write** button . A CoAP server is publicly available at address 52.43.121.77.
7. To set the XBee Cellular Modem to send data to port 5683 in decimal, in the **DE** field, type **1633** and click the **Write** button.
8. To move into Transparent mode, in the **AP** field, select **0** and click the **Write** button.
9. Wait for the **AI** (Association Indication) value to change to **0** (Connected to the Internet). You can click **Read**  to get an update on the **AI** value.



## Example: manually perform a CoAP request

Follow the steps in [Configure the device](#) prior to this example. This example performs the CoAP GET request:

- Method: GET
  - URI: example
  - Given message token: test
1. Click the **Consoles working mode** button  on the toolbar to add a customized packet.
  2. From the AT console, click the **Add new packet button**  in the Send packets dialog. The **Add new packet** dialog appears.
  3. Click the **HEX** tab and type the name of the data packet: **GET\_EXAMPLE**.
  4. Copy and past the following text into the **HEX** input tab:
 

```
44 01 C4 09 74 65 73 74 B7 65 78 61 6D 70 6C 65
```

 This is the CoAP protocol message decomposed by bytes to perform a GET request on an example URI with a token test.
  5. Click **Add packet**.
  6. Click the **Open** button .
  7. Click **Send selected packet**. The message is sent to the public CoAP server configured in [Configure the device](#). A response appears in the Console log. Blue text is the query, red text is the response.

The payload is **Get to uri: example**, which specifies that this is a successful CoAP GET to URI end example, which was specified in the query.

Click the **Close** button to terminate the serial connection.

## Example: use Python to generate a CoAP message

This example illustrates how the CoAP protocol can perform GET/POST/PUT/DELETE requests similarly to the HTTP protocol and how to do this using the XBee Cellular Modem. In this example, the XBee Cellular Modem talks to a CoAP Digi Server. You can use this client code to provide an abstract wrapper to generate a CoAP message that commands the XBee Cellular Modem to talk to the remote CoAP server.

---

**Note** It is crucial to configure the XBee Cellular Modem settings. See [Configure the device](#) and follow the steps. You can target the IP address to a different CoAP public server.

---

1. Install Python 2.7. The Installation guide is located at: <https://www.python.org/downloads/>.
2. Download and install the Coapthon library in the python environment from <https://pypi.python.org/pypi/CoAPthon>.
3. Download these two .py files: [Coap.py](#) and [CoapParser.py](#).
4. In the folder that you place the Coap.py and CoapParser.py files, press **Shift + right-click** and then click **Open command window**.
5. At the command prompt, type **python Coap.py** and press **Enter** to run the program.

6. Type the USB port number that the XBee Cellular Modem is connected to and press **Enter**. Only the port number is required, so if the port is COM19, type 19.

**Note** If you do not know the port number, open XCTU and look at the XBee Cellular Modem in the **Radio Modules** list. This view provides the port number and baud rate, as in the figure below where the baud rate is 9600 b/s.

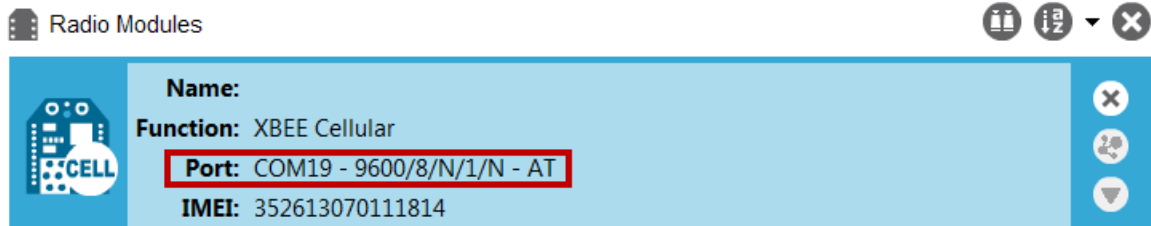

7. Type the baud rate and press **Enter**. You must match the device's current baud rate. XCTU provides the current baud rate in the **BD Baud Rate** field. In this example you would type **9600**.
8. Press **Y** if you want an auto-generated example. Press **Enter** to build your own CoAP request.
9. If you press **Y** it generates a message with:
  - Method: POST
  - URI: example
  - payload: hello world
  - token: test

The send and receive message must match the same token and message id. Otherwise, the client re-attempts the connection by sending out the request.

In the following figure, the payload contains the server response to the query. It shows the results for when you press **Enter** rather than **Y**.

```
C:\Users\jzhang\Desktop\example>python Coap.py
Please enter the serial port number for Xbee: 18
Please enter the baudrate number of Xbee: (9600 or 115200): 9600
Do you want an auto-generated example <Press Y> or build your own <Press ENTER>:

Please enter the HTTP method (GET, POST, PUT, DELETE): PUT
Please enter the uri end path: example
Please enter the payload content. And it cannot be empty: hello world
Please enter the token: digi

#####

This is the send out message:
Source: (None, None)
Destination: None
Type: CON
MID: 56045
Code: PUT
Token: digi
Uri-Path: example
Payload:
hello world

This is the received message
Source: (None, None)
Destination: None
Type: ACK
MID: 56045
Code: CHANGED
Token: digi
Payload:
Put hello world to uri: example
```

## Configure the XBee Cellular Modem using Digi Remote Manager

Use Digi Remote Manager (<https://remotemanager.digi.com/>) to perform the operations in this section. Each operation requires that you enable Remote Manager with the **DO** command and that you connect the XBee Cellular Modem to an access point that has an external Internet connection to allow access to Digi Remote Manager.

---

**Note** Digi is consolidating our cloud services, Digi Device Cloud and Digi Remote Manager®, under the Remote Manager name. This phased process does not affect device functionality or the functionality of the web services and other features. However, customers will find that some user interface and firmware functionality mention both Device Cloud and Digi Remote Manager.

---

### Create a Remote Manager account

Digi Remote Manager is an on-demand service with no infrastructure requirements. Remote devices and enterprise business applications connect to Remote Manager through standards-based web services. This section describes how to configure and manage an XBee using Remote Manager. For detailed information on using Remote Manager, refer to the Remote Manager User Guide, available via the Documentation tab in Remote Manager.

Before you can manage an XBee with Remote Manager, you must create a Remote Manager account. To create a Remote Manager account:

1. Go to <https://www.digi.com/products/cloud/digi-remote-manager>.
2. Click **30 DAY FREE TRIAL/LOGIN**.
3. Follow the online instructions to complete account registration. You can upgrade your Developer account to a paid account at any time.

When you are ready to deploy multiple XBee Cellular Modems in the field, upgrade your account to access additional Remote Manager features.

### Get the XBee Cellular Modem IMEI number

Before adding an XBee to your Remote Manager account inventory, you need to determine the International Mobile Equipment Identity (IMEI) number for the device. Use XCTU to view the IMEI number by querying the **IM** parameter.

### Add a XBee Cellular Modem to Remote Manager

To add an XBee to your Remote Manager account inventory, follow these steps:

Go to <https://remotemanager.digi.com/>.

1. Log in to your account
2. Click **Device Management > Devices**.
3. Click **Add Devices**. The Add Devices dialog appears.
4. Select **IMEI #**, and type or paste the IMEI number of the XBee you want to add. The **IM (IMEI)** command provides this number.

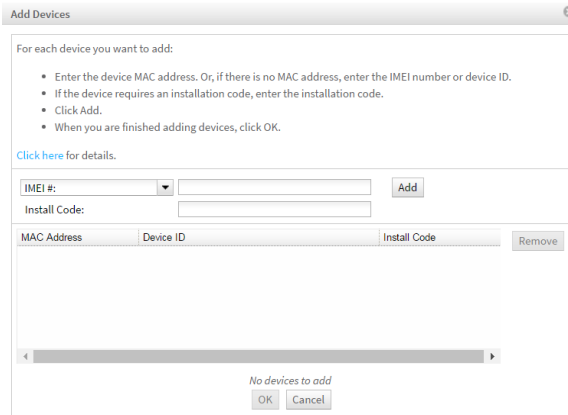

5. Click **Add** to add the device. The XBee is added to your inventory.
6. Click **OK** to close the Add Devices dialog and return to the Devices view.

## Update the firmware

XBee Cellular Modem supports Remote Manager firmware updates. To perform a firmware update, use the following steps.

1. Download the updated firmware file for your device from [Digi's support site](#). This is a zip file containing .ebin and .mxi files for import.
2. Unzip the file.
3. In your Remote Manager account, click **Device Management > Devices**.
4. Select the first device you want to update.
5. To select multiple devices (must be of the same type), press the Control key and select additional devices.
6. Click **More** in the Devices toolbar and select **Update Firmware** from the Update category of the More menu. The Update Firmware dialog appears.
7. Click **Browse** to select the .ebin file that you unzipped earlier.
8. Click **Update Firmware**. The updated devices automatically reboot when the updates are complete.

## Get started with MicroPython

---

This guide provides an overview of how to use MicroPython with the XBee Cellular Modem. For in-depth information and more complex code examples, refer to the [Digi MicroPython Programming Guide](#). Continue with this guide for simple examples to get started using MicroPython on the XBee Cellular Modem.

About MicroPython .....	47
MicroPython on the XBee Cellular Modem .....	47
Use XCTU to enter the MicroPython environment .....	47
Use the MicroPython Terminal in XCTU .....	48
Example: hello world .....	48
Example: turn on an LED .....	48
Example: code a request help button .....	49
Exit MicroPython mode .....	54
Other terminal programs .....	54
Use picocom in Linux .....	55

## About MicroPython

MicroPython is an open-source programming language based on Python 3, with much of the same syntax and functionality, but modified to fit on small devices with limited hardware resources, such as microcontrollers, or in this case, a cellular modem.

### Why use MicroPython

MicroPython enables on-board intelligence for simple sensor or actuator applications using digital and analog I/O. MicroPython can help manage battery life. Cryptic readings can be transformed into useful data, excess transmissions can be intelligently filtered out, modern sensors and actuators can be employed directly, and logic can glue inputs and outputs together in an intelligent way.

For more information about MicroPython, see [www.micropython.org](http://www.micropython.org).

For more information about Python, see [www.python.org](http://www.python.org).

## MicroPython on the XBee Cellular Modem

The XBee Cellular Modem has MicroPython running on the device itself. You can access a MicroPython prompt from the XBee Cellular Modem when you install it in an appropriate development board (XBDB or XBIB), and connect it to a computer via a USB cable.

The examples in this guide assume:

- You have [XCTU](#) on your computer. See [Configure the device using XCTU](#).
- You have a terminal program installed on your computer. We recommend using the [Use the MicroPython Terminal in XCTU](#). This requires XCTU 6.3.7 or higher.
- You have an XBee Cellular Modem installed in an appropriate development board such as an XBIB-U-DEV or an XBIB-2.

---

**Note** Most examples in this guide require the XBIB-U-DEV board.

---

- The XBee Cellular Modem is connected to the computer via a USB cable and XCTU recognizes it.
- The board is powered by an appropriate power supply, 12 VDC and at least 1.1 A.

## Use XCTU to enter the MicroPython environment



To use the XBee Cellular Modem in the MicroPython environment:

1. Use XCTU to add the device(s); see [Configure the device using XCTU](#) and [Add a device](#).
2. The XBee Cellular Modem appears as a box in the **Radio Modules** information panel. Each module displays identifying information about itself.
3. Click this box to select the device and load its current settings.
4. To set the device's baud rate to 115200 b/s, in the **BD** field select **115200 [7]** and click the **Write** button . We recommend using flow control to avoid data loss, especially when pasting large amounts of code/text.

5. To put the XBee Cellular Modem into MicroPython mode, in the **AP** field select **MicroPython REPL [4]** and click the **Write** button .
6. Note what COM port(s) the XBee Cellular Modem is using, because you will need this information when you use terminal communication.

## Use the MicroPython Terminal in XCTU

You can use the MicroPython Terminal to communicate with the XBee Cellular Modem when it is in MicroPython mode.<sup>1</sup> This requires XCTU 6.3.7 or higher. To enter MicroPython mode, follow the steps in [Use XCTU to enter the MicroPython environment](#). To use the MicroPython Terminal:

1. Click the **Tools** drop-down menu  and select **MicroPython Terminal**. The terminal opens.
2. Click **Open**.
3. In the **Select the Serial/USB port** area, click the COM port that the device uses.
4. Verify that the baud rate and other settings are correct.
5. Click **OK**. The **Open** icon changes to **Close** , indicating that the device is properly connected.

You can now type or paste MicroPython code in the terminal.

### Example: hello world

1. At the MicroPython `>>>` prompt, type the Python command: `print("Hello, World!")`
2. Press **Enter** to execute the command. The terminal echos back **Hello, World!**.

### Example: turn on an LED

1. Note the **DS4** LED on the XBIB board. The following image highlights it in a red box. The LED is normally off.

---

<sup>1</sup>See [Other terminal programs](#) if you do not use the MicroPython Terminal in XCTU.



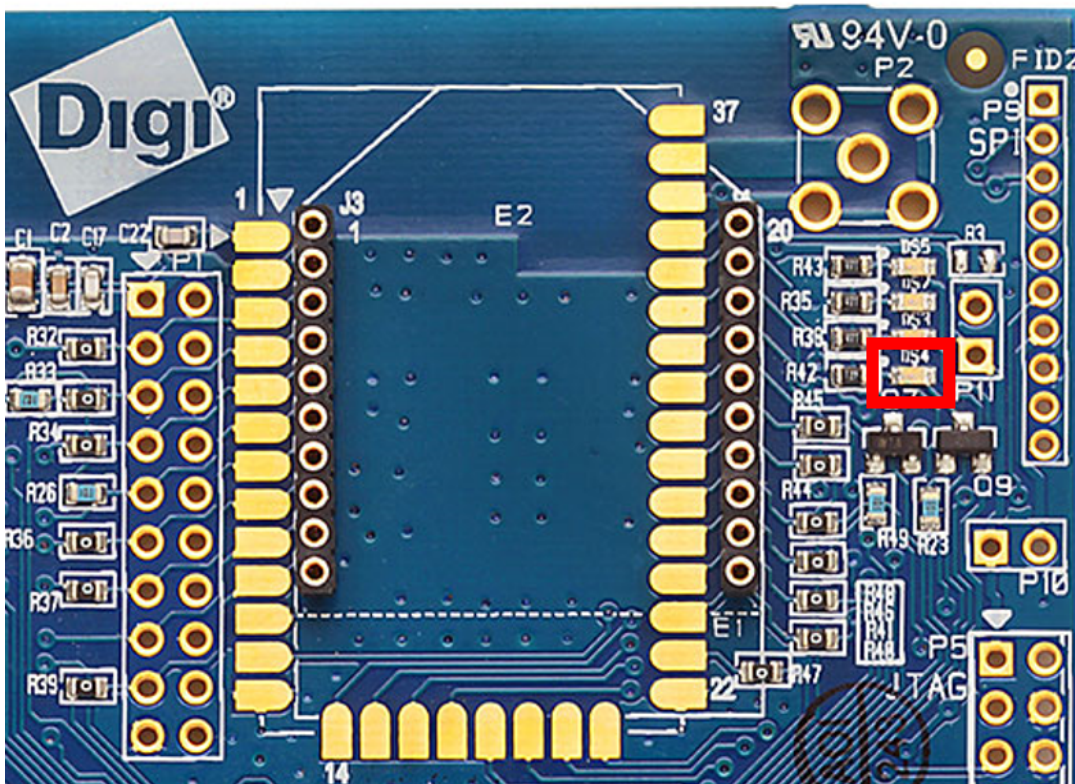

- At the MicroPython >>> prompt, type the commands below, pressing **Enter** after each one. After entering the last line of code, the LED illuminates. Anything after a # symbol is a comment, and you do not need to type it.

Do not copy code from the PDF and paste it into a MicroPython terminal, as any blank spaces at the beginning of a line of code are ignored. You can copy code correctly from the HTML version of the document.

```
import machine
from machine import Pin
led = Pin("D4", Pin.OUT, value=0) # Makes a pin object set to output 0.
# One might expect 0 to mean OFF and 1 to mean ON, and this is normally the
# case.
# But the LED we are turning on and off is setup as what is# known as
# "active low".
# This means setting the pin to 0 allows current to flow through the LED and
# then through the pin, to ground.
```

- To turn it off, type the following and press **Enter**:

```
led.value(1)
```

You have successfully controlled an LED on the board using basic I/O!

## Example: code a request help button

This example provides a fast, deep dive into MicroPython designed to let you see some of the powerful things it can do with minimal code. It is not meant as a tutorial; for in-depth examples refer to the [Digi](#)

### MicroPython Programming Guide.

Many stores have help buttons in their aisles that a customer can press to alert the store staff that assistance is required in that aisle. You can implement this type of system using the Digi XBee Cellular Modem, and this example provides the building blocks for such a system. This example, based on SMS paging, can have many other uses such as alerting someone with a text to their phone if a water sensor in a building detects water on the floor, or if a temperature sensor reports a value that is too hot or cold relative to normal operation.

## Enter MicroPython paste mode

In the following examples it is helpful to know that MicroPython supports [paste mode](#), where you can copy a large block of code from this user guide and paste it instead of typing it character by character. To use paste mode:

1. Copy the code you want to run. For example, copy the following code that is the code from the LED example:

---

```
from machine import Pin
led = Pin("D4", Pin.OUT, value=0)
```

---

Do not copy code from the PDF and paste it into a MicroPython terminal, as any blank spaces at the beginning of a line of code are ignored. You can copy code correctly from the HTML version of the document.

2. In the terminal, at the MicroPython `>>>` prompt type **Ctrl+E** to enter paste mode. The terminal displays **paste mode; Ctrl-C to cancel, Ctrl-D to finish**.
3. The code appears in the terminal occupying four lines, each line starts with its line number and three `=` symbols. For example line 1 starts with **1===**.
4. If the code is correct, press **Ctrl+D** to run the code and you should once again see the **DS4** LED turn on. If you get a **Line 1 SyntaxError: invalid syntax** error, see [Syntax error at line 1](#). (If you wish to exit paste mode without running the code, for example, or if the code did not copy correctly, press **Ctrl+C** to cancel and return to the normal MicroPython `>>>` prompt).
5. Next turn the LED off. Copy the code below:

---

```
from machine import Pin
led = Pin("D4", Pin.OUT, value=1)
print("DS4 LED now OFF!")
print("Paste Mode Successful!")
```

---

6. Press **Ctrl+E** to enter paste mode, and paste the copied code.
7. If the code is correct, press **Ctrl+D** to run it. The LED should turn off and you should see two confirmation messages print to the screen.

## Catch a button press

For this part of the example, you write code that responds to a button press on the XBIB-U-DEV board that comes with the XBee Cellular Modem Development Kit. The code monitors the pin connected to the button on the board labeled **SW2**.

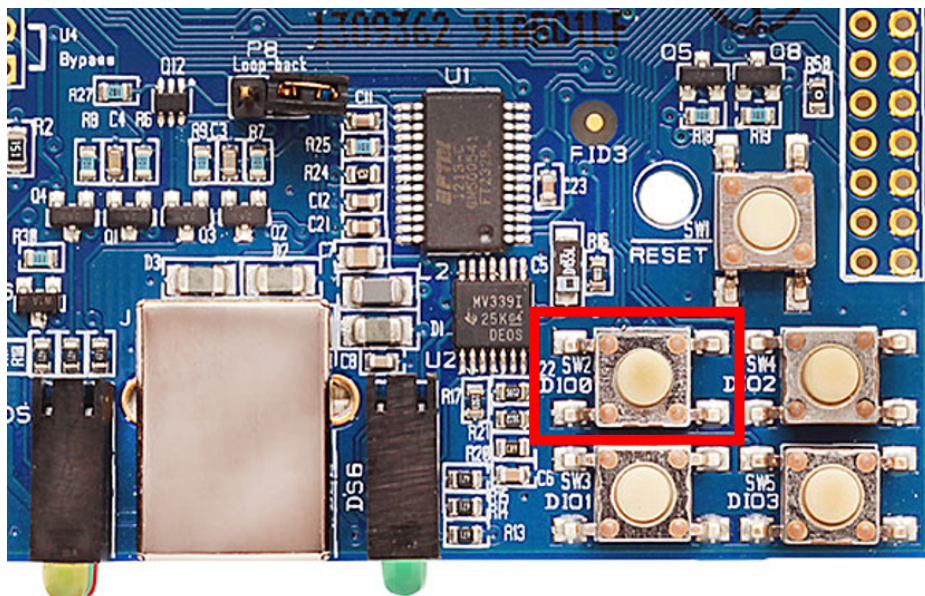

On the board you see **DIO0** written below **SW2**, to the left of the button. This represents the pin that the button is connected to.

In MicroPython, you will create a pin object for the pin that is connected to the **SW2** button. When you create the pin object, the **DIO0** pin is called **D0** for short.

The loop continuously checks the value on that pin and once it goes to **0** (meaning the button has been pressed) a **print()** call prints the message **Button pressed!** to the screen.

At the MicroPython **>>>** prompt, copy the following code and enter it into MicroPython using [paste mode](#) and then run it:

---

```
# Import the Pin module from machine, for simpler syntax.
from machine import Pin

# Create a pin object for the pin that the button "SW2" is connected to.
dio0 = Pin("D0", Pin.IN, Pin.PULL_UP)
# Give feedback to inform user a button press is needed.
print("Waiting for SW2 press...")
# Create a WHILE loop that checks for a button press.
while (True):
    if (dio0.value() == 0): # Once pressed.
        print("Button pressed!") # Print message once pressed.
        break # Exit the WHILE loop.

# When you press SW2, you should see "Button pressed!" printed to the
screen.
# You have successfully performed an action in response to a button press!
```

---

Do not copy code from the PDF and paste it into a MicroPython terminal, as any blank spaces at the beginning of a line of code are ignored. You can copy code correctly from the HTML version of the document.

**Note** If you have problems pasting the code, see [Syntax error at line 1](#). For SMS failures, see [Error Failed to send SMS](#).

---

## Send a text (SMS) when the button is pressed

After [creating a while loop](#) that checks for a button press, add sending an SMS to your code. Instead of printing **Button pressed!** to the screen, this code sends **Button pressed** to a cell phone as a text (SMS) message.

To accomplish this, use the `sms_send()` method, which sends a string to a given phone number. It takes the arguments in the order of

1. **<phone number>**
2. **<message-to-be-sent>**

Before you run this part of the example, you must create a variable that holds the phone number of the cell phone or mobile device you want to receive the SMS.

1. To do this, at the MicroPython `>>>` prompt, type the following command, replacing **1123456789** with the full phone number (no dashes, spaces, or other symbols) and press **Enter**:

---

```
ph = 1123456789
```

---

2. After you create this **ph** variable with your phone number, copy the code below and enter it into MicroPython using [paste mode](#) and then run it.

---

```
from machine import Pin
import network # Import network module
import time

c = network.Cellular() # initialize cellular network parameter
dio0 = Pin("D0", Pin.IN, Pin.PULL_UP)
while not c.isconnected(): # While no network connection.
    print("Waiting for connection to cell network...")
    time.sleep(5)
print("Connected.")
# Give feedback to inform user a button press is needed.
print("Waiting for SW2 press...")
while (True):
    if (dio0.value() == 0):
        # When SW2 is pressed, the module will send an SMS
        # message saying "Button pressed" to the given target cell phone
        number.
        try:
            c.sms_send(ph, 'Button Pressed')
            print("Sent SMS successfully.")
        except OSError:
            print("ERROR- failed to send SMS.")
        # Exit the WHILE loop.
        break
```

---

Do not copy code from the PDF and paste it into a MicroPython terminal, as any blank spaces at the beginning of a line of code are ignored. You can copy code correctly from the HTML version of the document.

---

**Note** If you have problems pasting the code, see [Syntax error at line 1](#). For SMS failures, see [Error Failed to send SMS](#).

---

## Add the time the button was pressed

After you [add the ability to send an SMS](#) to the code, add functionality to insert the time at which the button was pressed into the SMS that is sent. To accomplish this:

1. Create a UDP socket with the **socket()** method.
2. Save the IP address and port of the time server in the **addr** variable.
3. Connect to the time server with the **connect()** method.
4. Send **hello** to the server to prompt it to respond with the current date and time.
5. Receive and store the date/time response in the **buf** variable.
6. Send an SMS in the same manner as before using the **sms\_send()** method, except that you add the time into the SMS message, such that the message reads: **[Button pressed at: b'YYYY-MM-DD HH:MM:SS\n' ]**

To verify that your phone number is still in the memory, at the MicroPython **>>>** prompt, type **ph** and press **Enter**.

If MicroPython responds with your number, copy the following code and enter it into MicroPython using [paste mode](#) and then run it. If it returns an error, enter your number again as shown in [Send a text \(SMS\) when the button is pressed](#). With your phone number in memory in the **ph** variable, copy the code below and enter it into MicroPython using [paste mode](#) and then run it.

---

```

from machine import Pin
import network
import usocket
import time

c = network.Cellular()
dio0 = Pin("D0", Pin.IN, Pin.PULL_UP)
while not c.isconnected(): # While no network connection.
    print("Waiting for connection to cell network...")
    time.sleep(5)
print("Connected.")
# Give feedback to inform user a button press is needed.
print("Waiting for SW2 press...")
while (1):
    if (dio0.value() == 0):
        # When button pressed, now the module will send "Button Press" AND
        # the time at which it was pressed in an SMS message to the given
        # target cell phone number.
        socketObject = usocket.socket(usocket.AF_INET, usocket.SOCK_DGRAM)
        # Connect the socket object to the web server specified in
        "address".
        addr = ("52.43.121.77", 10002)
        socketObject.connect(addr)
        bytessent = socketObject.send("hello")
        print("Sent %d bytes on socket" % bytessent)
        buf = socketObject.recv(1024)
        # Send message to the given number. Handle error if it occurs.
        try:
            c.sms_send(ph, 'Button Pressed at: ' + str(buf))
            print("Sent SMS successfully.")
        except OSError:
            print("ERROR- failed to send SMS.")

```

---



---

```
# Exit the WHILE loop.  
break
```

---

Do not copy code from the PDF and paste it into a MicroPython terminal, as any blank spaces at the beginning of a line of code are ignored. You can copy code correctly from the HTML version of the document.

Now you have a system based on the XBee Cellular Modem that sends an SMS in response to a certain input, in this case a simple button press.



---

**Note** If you have problems pasting the code, see [Syntax error at line 1](#). For SMS failures, see [Error Failed to send SMS](#).

---

## Exit MicroPython mode

To exit MicroPython mode:

1. In the XCTU MicroPython Terminal, click the green **Close** button .
2. Click **Close** at the bottom of the terminal to exit the terminal.
3. In XCTU's Configuration working mode , change **AP API Enable** to another mode and click the **Write** button .

## Other terminal programs

If you do not use the MicroPython Terminal in XCTU, you can use other terminal programs to communicate with the XBee Cellular Modem. If you use Microsoft Windows, follow the instructions for Tera Term, if you use Linux, follow the instructions for picocom. To download these programs:

- Tera Term for Windows; see <https://tssh2.osdn.jp/index.html.en>.
- Picocom for Linux; see [https://developer.ridgerun.com/wiki/index.php/Setting\\_up\\_Picocom\\_-\\_Ubuntu](https://developer.ridgerun.com/wiki/index.php/Setting_up_Picocom_-_Ubuntu) and for the source code and in-depth information <https://github.com/npatefault/picocom>.

## Tera Term for Windows

With the XBee Cellular Modem in MicroPython mode (**AP = 4**), you can access the MicroPython prompt using a terminal.

1. Open Tera Term. The **Tera Term: New connection** window appears.
2. Click the **Serial** radio button to select a serial connection.
3. From the **Port:** drop-down menu, select the COM port that the XBee Cellular Modem is connected to.
4. Click **OK**. The **COMxx - Tera Term VT** terminal window appears and Tera Term attempts to connect to the device at a baud rate of 9600 b/s. The terminal will not allow communication with the device since the baud rate setting is incorrect. You must change this rate as it was previously set to 115200 b/s.
5. Click **Setup** and **Serial Port**. The **Tera Term: Serial port setup** window appears.

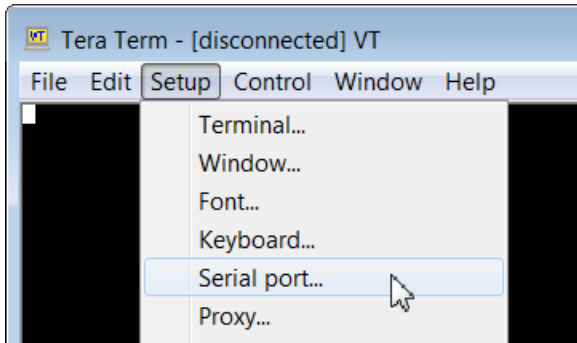

6. In the **Tera Term: Serial port setup** window, set the parameters to the following values:
  - **Port:** Shows the port that the XBee Cellular Modem is connected on.
  - **Baud rate:** 115200
  - **Data:** 8 bit
  - **Parity:** none
  - **Stop:** 1 bit
  - **Flow control:** hardware
  - **Transmit delay:** N/A
7. Click **OK** to apply the changes to the serial port settings. The settings should go into effect right away.
8. To verify that local echo is not enabled and that extra line-feeds are not enabled:
  - a. In Tera Term, click **Setup** and select **Terminal**.
  - b. In the **New-line** area of the **Tera Term: Serial port setup** window, click the **Receive** drop-down menu and select **CR** if it does not already show that value.
  - c. Make sure the **Local echo** box is not checked.
9. Click **OK**.
10. Press **Ctrl+B** to get the MicroPython version banner and prompt.

```
MicroPython v1.8.7 on 2017-04-06; XBee Cellular with EFM32G
Type "help()" for more information.
>>>
```

Now you can type MicroPython commands at the >>> prompt.

## Use picocom in Linux

With the XBee Cellular Modem in MicroPython mode (**AP = 4**), you can access the MicroPython prompt using a terminal.

---

**Note** The user must have read and write permission for the serial port the XBee Cellular Modem is connected to in order to communicate with the device.

---

1. Open a terminal in Linux and type **picocom -b 115200 /dev/ttyUSB0**. This assumes you have no other USB-to-serial devices attached to the system.
2. Press **Ctrl+B** to get the MicroPython version banner and prompt. You can also press **Enter** to bring up the prompt.

If you do have other USB-to-serial devices attached:

1. Before attaching the XBee Cellular Modem, check the directory **/dev/** for any devices named **ttUSBx**, where **x** is a number. An easy way to list these is to type: **ls /dev/ttyUSB\***. This produces a list of any device with a name that starts with **ttUSB**.
2. Take note of the devices present with that name, and then connect the XBee Cellular Modem.
3. Check the directory again and you should see one additional device, which is the XBee Cellular Modem.
4. In this case, replace **/dev/ttyUSB0** at the top with **/dev/ttyUSB<number>**, where **<number>** is the new number that appeared.
5. It should connect and show Terminal ready.

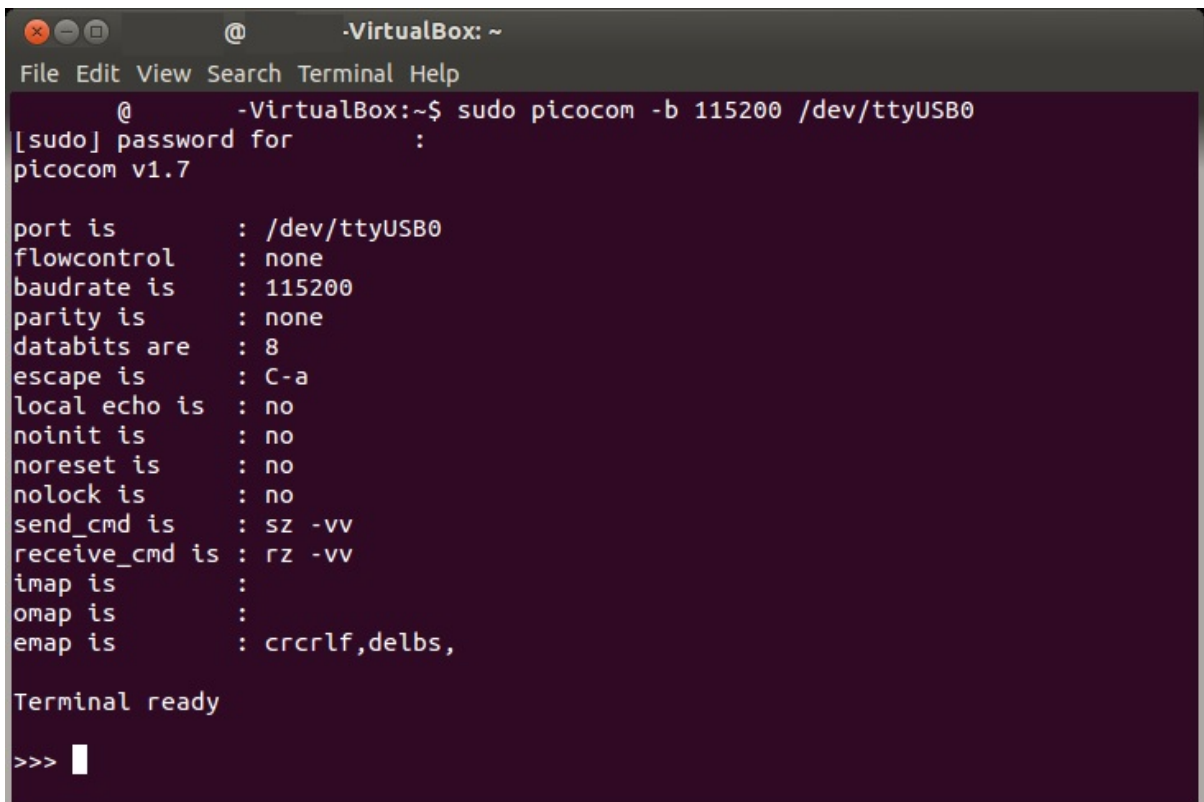

```
-VirtualBox: ~
File Edit View Search Terminal Help
@ -VirtualBox:~$ sudo picocom -b 115200 /dev/ttyUSB0
[sudo] password for :
picocom v1.7

port is      : /dev/ttyUSB0
flowcontrol  : none
baudrate is  : 115200
parity is    : none
databits are : 8
escape is    : C-a
local echo is : no
noinit is    : no
noreset is   : no
nolock is    : no
send_cmd is  : SZ -vv
receive_cmd is : rZ -vv
imap is      :
omap is      :
emap is      : crclrf,delbs,

Terminal ready

>>> █
```

Now you can type MicroPython commands at the **>>>** prompt.



## Technical specifications

---

Interface and hardware specifications .....	58
RF characteristics .....	58
Networking specifications .....	58
Power requirements .....	58
Power consumption .....	59
Electrical specifications .....	59
Regulatory approvals .....	60

## Interface and hardware specifications

The following table provides the interface and hardware specifications for the device.

Specification	Value
Dimensions	2.438 x 3.294 cm (0.960 x 1.297 in)
Weight	5 g (0.18 oz)
Operating temperature	-40 to +80 °C
Antenna connector	U.FL for primary and secondary antennas
Digital I/O	13 I/O lines
ADC	4 10-bit analog inputs

## RF characteristics

The following table provides the RF characteristics for the device.

Specification	Value
Modulation	LTE/4G – QPSK, 16 QAM
Transmit power	23 dBm
Receive sensitivity	-102 dBm
Over-the-air maximum data rate	10 Mb/s
Data throughput	TBD

## Networking specifications

The following table provides the networking and carrier specifications for the device.

Specification	Value
Addressing options	TCP/IP and SMS
Carrier and technology	Verizon 4G LTE Cat 1
Supported bands	4 and 13
Security	SSL/TLS

## Power requirements

The following table provides the power requirements for the device.

Specification	Value
Supply voltage	3.0 to 5.5 V
Extended voltage range	2.7 to 5.5 VDC

## Power consumption

The peak current was measured from multiple tested units.

Specification	State	Average current	Measured peak current
Tx+RX current	Active transmit, 23 dBm @ 3.3 V	860 mA	1020 mA
Tx+RX current	Active transmit, 23 dBm @ 5.0 V	555 mA	630 mA
TX Only current	Active transmit, 23 dBm @ 3.3 V	680 mA	N/A
Rx + ACK current	Active receive @ 3.3 V	530 mA	N/A
Rx + ACK current	Active receive @ 5 V	360 mA	N/A
RX Only current	Active receive @ 3.3 V	300 mA	N/A
Idle current	Idle/connected, listening @ 3.3 V	143 mA	N/A
Idle current	Idle/connected, listening @ 5 V	100 mA	N/A
Sleep current	Not connected, Deep Sleep @ 3.3 V	10 µA	N/A

## Electrical specifications

The following table provides the electrical specifications for the XBee Cellular Modem.

Symbol	Parameter	Condition	Min	Typical	Max	Units
VCCMAX	Maximum limits of VCC line		0		5.5	V
VDD_IO	Internal supply voltage for I/O	While in deep sleep and during initial power up	Min (VCC-0.3, 3.3)		3.3	V
VDD_IO	Internal supply voltage for I/O	In normal running mode		3.3 V		V
VI	Voltage on any pin		-0.3		VDD_IO + 0.3	V
VIL	Input low voltage				0.3*VDD_IO	V
VIH	Input high voltage		0.7*VDD_IO			V

Symbol	Parameter	Condition	Min	Typical	Max	Units
VOL	Voltage output low	Sinking 6 mA VDD_IO = 3.3 V			0.2*VDD_IO	V
VOH	Voltage output high	Sourcing 6 mA VDD_IO = 3.3 V	0.75*VDD_IO			V
I_IN	Input leakage current	High Z state I/O connected to Ground or VDD_IO		0.1	100	nA
RPU	Internal pull-up resistor	Enabled		40		kΩ
RPD	Internal pull-down resistor	Enabled		40		kΩ

## Regulatory approvals

The following table provides the regulatory and carrier approvals for the device.

Specification	Value
United States	Contains FCC ID: R17LE866SV1
Industry Canada	Contains IC: 5131A-LE866SV1
Europe (CE)	N/A
RoHS	Lead-free and RoHS compliant
Australia	N/A
Verizon end-device certified	Yes

## Hardware

---

Mechanical drawings .....	62
Pin signals .....	62
Antenna connections .....	63
Antenna placement .....	64
SIM card .....	64
The Associate LED .....	64
Heat considerations .....	65
Heat sink considerations .....	66
Power supply considerations .....	66
Add a capacitor to the RESET line .....	67

## Mechanical drawings

The following figures show the mechanical drawings for the XBee Cellular Modem. The drawings do not show antenna options. All dimensions are in inches.

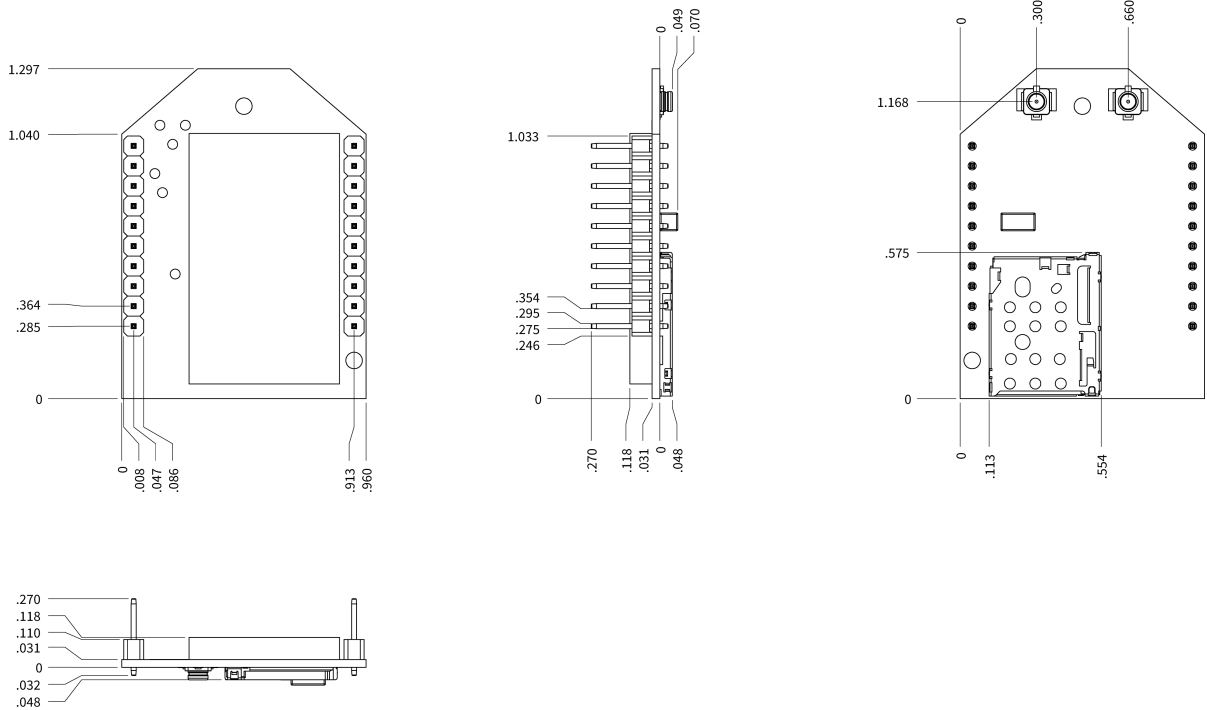

## Pin signals

The following table shows the pin assignments for the through-hole device. In the table, low-asserted signals have a horizontal line above signal name.

Pin	Name	Direction	Default	Description
Pin	Name	Direction	Default	Description
1	V <sub>CC</sub>			Power supply
2	DOUT	Output	Output	UART Data Out
3	DIN / <u>CONFIG</u>	Input	Input	UART Data In
4	DIO12	Either		Digital I/O 12
5	<u>RESET</u>	Input		
6	PWM0 / RSSI / DIO10	Either	Output	PWM Output 0 / RX Signal Strength Indicator / Digital I/O10

Pin	Name	Direction	Default	Description
7	PWM1 / DIO11	Either		PWM Output 1 / Digital I/O 11
8	[reserved]			Do not connect
9	$\overline{\text{DTR}}$ / SLEEP_RQ/ DIO8			Pin Sleep Control Line or Digital I/O 8
10	GND			Ground
11	DIO4	Either		Digital I/O 4
12	$\overline{\text{CTS}}$ / DIO7	Either	Output	Output Clear-to-Send Flow Control or Digital I/O 7
13	ON $\overline{\text{SLEEP}}$ /DIO9	Output	Output	Module Status Indicator or Digital I/O 9
14	VREF	Unused		This line is not connected. It is used on other XBee products.
15	Associate / DIO5	Either	Output	Associated Indicator, Digital I/O 5
16	$\overline{\text{RTS}}$ / DIO6	Either	Disabled	Input Request-to-Send Flow Control, Digital I/O 6
17	AD3 / DIO3	Either	Disabled	Analog Input 3 or Digital I/O 3
18	AD2 / DIO2	Either	Disabled	Analog Input 2 or Digital I/O 2
19	AD1 / DIO1	Either	Disabled	Analog Input 1 or Digital I/O 1
20	AD0 / DIO0	Either	Input	Analog Input 0, Digital I/O 0

## Pin connection recommendations

The recommended minimum pin connections are VCC, GND, DIN, DOUT,  $\overline{\text{RTS}}$ ,  $\overline{\text{DTR}}$  and  $\overline{\text{RESET}}$ . Firmware updates require access to these pins.

## Antenna connections



**CAUTION!** The XBee Cellular Modem will not function properly with only the secondary antenna port connected!

The XBee Cellular Modem has two U.FL antenna ports; a primary on the upper left of the board and a secondary port on the upper right, see the drawing below. You must connect the primary port and the

secondary port is optional. The secondary antenna improves receive performance in certain situations, so we recommend it for best results.

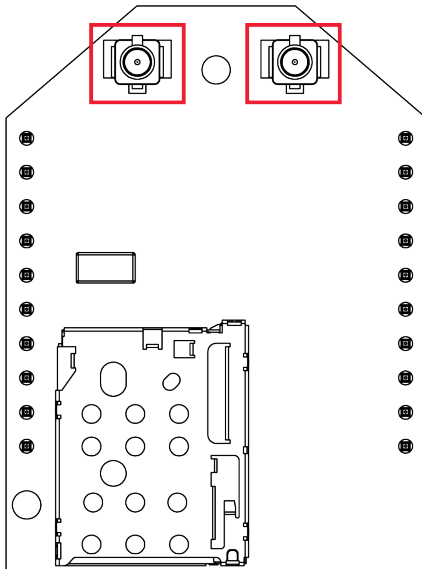

## Antenna placement

It is important to keep the antenna as far away from the XBee Cellular Modem and other metal objects as possible. Often, small antennas are desirable, but at the cost of increasing size of dead zones because of reduced range and efficiency.

We recommend that antennas do not touch each other, but the XBee Cellular Modem works if they do. To optimize receive performance, orient the two antennas at right angles to each other.

## SIM card

The XBee Cellular Modem uses a 4FF (Nano) size SIM card.

---

**CAUTION!** Never insert or remove SIM card while the power is on!



## The Associate LED

The following table describes the Associate LED functionality. For the location of the Associate LED on the XBIB-U development board, see number 6 on the [XBIB-U-DEV reference](#).

LED status	Blink timing	Meaning
On, solid		Not joined to a mobile network.



LED status	Blink timing	Meaning
Double blink	½ second	The last TCP/UDP/SMS attempt failed. If the LED has this pattern, you may need to check <a href="#">DI (Device Cloud Indicator)</a> or <a href="#">CI (Protocol/Connection Indication)</a> for the cause of the error.
Standard single blink	1 second	Normal operation.

The normal association LED signal alternates evenly between high and low as shown below:



Where the low signal means LED off and the high signal means LED on.

When **CI** is not **0** or **0xFF**, the Associate LED has a different blink pattern that looks like this:



## Heat considerations

Depending on the use case, your application may require a heat sink. Use a non-conductive thermal gasket to make contact to the heat sink. The gasket should be thick enough to ensure that contact with the tallest component does not cause damage when pressure is applied to a secure heat sink.

We recommend connecting the heat sink to the top side of the XBee Cellular Modem without covering the U.FL connectors.

We do not recommend operating the unit above 80 °C.

The operation temperature of the unit can be approximated for different current draws and extreme cases by the equation below. For best results, attach a temperature probe just above the center of the XBee Cellular Modem. Alternatively use [TP \(Temperature\)](#) to query the current temperature of the device's processor.

$$MaxOperatingAmbientTemp^{\circ}C = 80^{\circ}C - (XBeeBoardTemp - RoomTemp) * ScenarioMaxCurrent / AverageCurrentDuringTest$$

Where

1. *XBeeBoardTemp* is the temperature of the XBee Cellular Modem at steady state.
  - a. Use the **TP** command to help estimate the temperature when attaching a temperature probe is not practical, but for reliable results, you must use a temperature probe.
2. *RoomTemp* is the temperature of the ambient air.
3. *AverageCurrentDuringTest* is the average current measured during test.
4. *ScenarioMaxCurrent* is the maximum current expected for the device.

### Add a fan to provide active cooling

The XBee Cellular Modem can become hot if you use it in the maximum upload or download scenarios, see [Heat considerations](#). You can attach a fan to the device to provide active cooling.

If you attach a fan, use [P1 \(DIO11/PWM1 Configuration\)](#) to enable this functionality on pin 7. Set **P1** to **1**, which turns the fan on when the device gets above 70 °C and the cellular component is running, and off below 65 °C.

## Heat sink considerations

The following table provides a set of typical heat sink examples for scenarios that customers may encounter.

The results may vary by implementation and scenario. You should always perform sufficient testing to ensure that the XBee Cellular Modem does not exceed temperature specifications.

Scenario	3.3 V average current	Scenario example	Peak MB consumed per hour	Maximum ambient temperature		
				No heat sink	Heat sink	Heat sink and fan
Maximum current	950 mA	Running video camera	200 to 2000	NR <sup>1</sup>	31 °C	70 °C
50% current	475 mA	Running low-resolution camera	80 to 500	42 °C	55 °C	75 °C
20% current	200 mA	Sending 2 MB picture of traffic every minute	10 to 100	64 °C	70 °C	78 °C
Device available	170 mA	Updating traffic sign	1 to 10	66 °C	71 °C	78 °C
Sleep current scenario—high latency	20 mA	Wakes at most once per hour to send and/or receive data	Less than 0.1	78 °C	78 °C	78 °C

## Power supply considerations

When considering a power supply, use the following design practices.

1. Keep power supply ripple below 75 mV peak to peak.
2. The power supply should be capable of providing a minimum of 1.5 A at 3.3 V (5 W).
3. Place sufficient bulk capacitance on the VCC to maintain voltage above the minimum specification during inrush current. Inrush current is about 2 A during initial power up of cellular communications and during cellular restart conditions.
4. Place smaller high frequency ceramic capacitors very close to the XBee Cellular Modem VCC pin to decrease high frequency noise.

---

<sup>1</sup>NR = not recommended.

- 5. The power supply trace must be thick enough to handle the current requirements with minimal voltage drop when peak currents are reached. Lower voltages require more current to achieve the same power output. Supply voltage steady state at VCC pin 1 should change by less than 0.1 V if drawing 0.5 W compared to drawing 2.8 W.

### Add a capacitor to the RESET line

In high EMI noise environments, we recommend adding a 10 nF ceramic capacitor very close to pin 5.

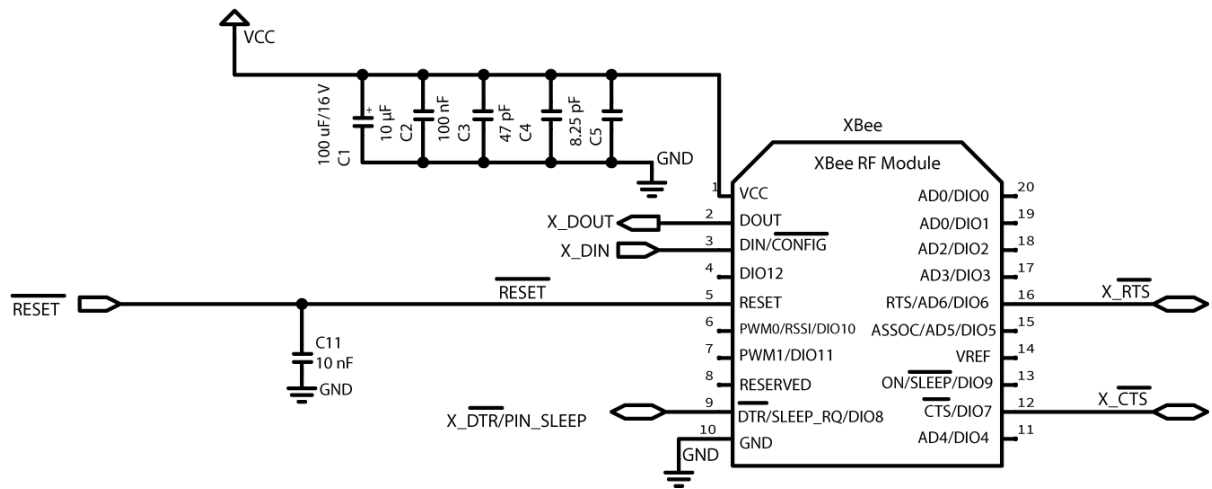

## Cellular connection process

---

Connecting .....	69
Cellular network .....	69
Data network connection .....	69
Data communication with remote servers (TCP/UDP) .....	69
Disconnecting .....	69
SMS encoding .....	70

## Connecting

In normal operations, the XBee Cellular Modem automatically attempts both a cellular network connection and a data network connection on power-up. The sequence of these connections is as follows:

### Cellular network

1. The device powers on.
2. It looks for cellular towers.
3. It chooses a candidate tower with the strongest signal.
4. It negotiates a connection.
5. It completes cellular registration; the phone number and SMS are available.

### Data network connection

1. The network enables the evolved packet system (EPS) bearer with an access point name (APN). See [AN \(APN\)](#) if you have APN issues.
2. The device negotiates a data connection with the access point.
3. The device receives its IP configuration and address.
4. The [AI \(Association Indication\)](#) command now returns a **0** and the sockets become available.

### Data communication with remote servers (TCP/UDP)

Once sockets become available, communication with remote servers can be initiated in several ways:

- Transparent mode data received over a serial connection (see [TD \(Text Delimiter\)](#) and [RO \(Packetization Timeout\)](#) for timing).
- API mode: [Transmit \(TX\) Request: IPv4 - 0x20](#) received over the serial connection.
- Digi Remote Manager connectivity begins.

Data communication begins when:

1. A socket opens to the remote server.
2. Data is sent.
3. The XBee Cellular Modem listens for incoming data.

Data connectivity ends when:

1. The server closes the connection.
2. The **TM** timeout expires (see [TM \(TCP Client Connection Timeout\)](#)).
3. The cellular network may also close the connection after a timeout set by the network operator.

## Disconnecting

When the XBee Cellular Modem is put into Airplane mode or deep sleep is requested:

1. Sockets are closed, cleanly if possible.
2. The EPS bearer data connection is shut down.
3. The cellular connection is shut down.
4. The cellular component is powered off.

## SMS encoding

The XBee Cellular Modem transmits SMS messages using the standard [GSM 03.38](#) character set.<sup>1</sup> Because this character set only provides 7 bits of space per character, the XBee Cellular Modem ignores the most significant bit of each octet in an SMS transmission payload.

The device converts incoming SMS messages to ASCII. Characters that cannot be represented in ASCII are replaced with a space (' ', or 0x20 in hex). This includes emoji and other special characters.

---

<sup>1</sup>Also referred to as the GSM 7-bit alphabet.

## Modes

---

Select an operating mode .....	72
Transparent operating mode .....	72
API operating mode .....	73
Bypass operating mode .....	73
Command mode .....	74

## Select an operating mode

The XBee Cellular Modem interfaces to a host device such as a microcontroller or computer through a logic-level asynchronous serial port. It uses a [UART](#) for serial communication with those devices.

The XBee Cellular Modem supports three operating modes: Transparent operating mode, API operating mode, and Bypass operating mode. The default mode is Transparent operating mode.

Use the [AP \(API Enable\)](#) command to select a different operating mode.

The following flowchart illustrates how the modes relate to each other.

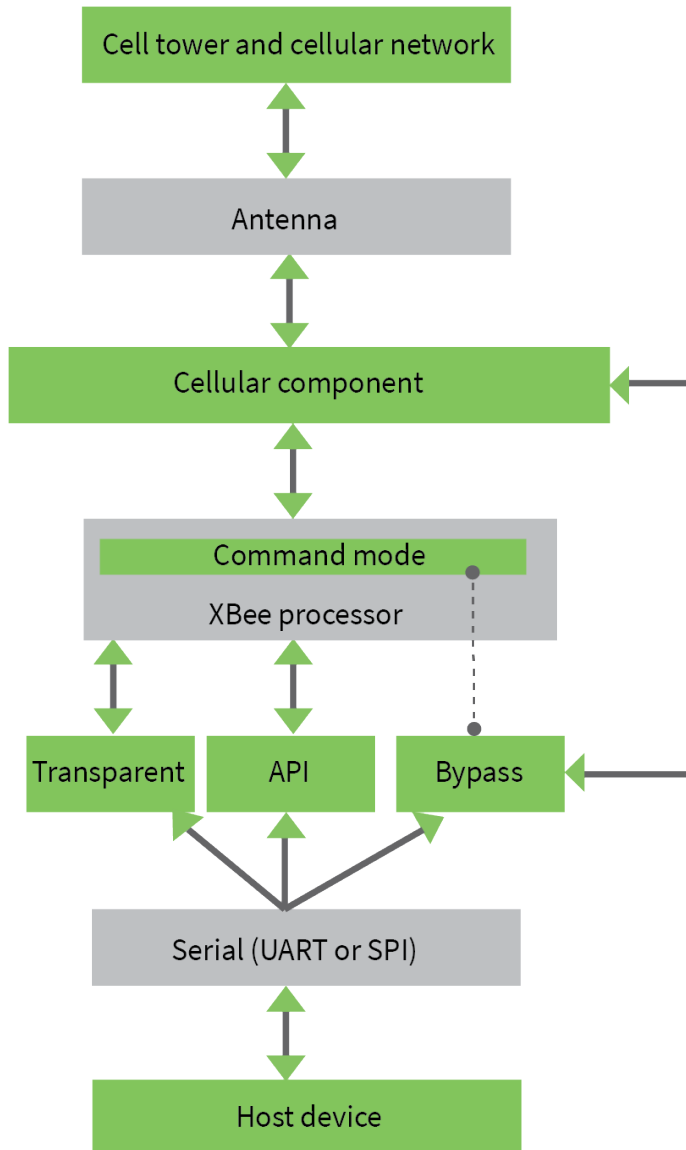

## Transparent operating mode

Devices operate in this mode by default. The device acts as a serial line replacement when it is in Transparent operating mode. The device queues all serial data it receives through the DIN pin for RF transmission. When a device receives RF data, it sends the data out through the DOUT pin. You can set the configuration parameters using Command mode.



The [IP \(IP Protocol\)](#) command setting controls how Transparent operating mode works for the XBee Cellular Modem.

## API operating mode

API operating mode is an alternative to Transparent operating mode. API mode is a frame-based protocol that allows you to direct data on a packet basis. The device communicates UART data in packets, also known as API frames. This mode allows for structured communications with computers and microcontrollers.

The advantages of API operating mode include:

- It is easier to send information to multiple destinations
- The host receives the source address for each received data frame
- You can change parameters without entering Command mode

## Bypass operating mode



**CAUTION!** Bypass operating mode is an alternative to Transparent and API modes for advanced users with special configuration needs. Changes made in this mode might change or disable the device and we do not recommend it for most users.

---

In Bypass mode, the device acts as a serial line replacement to the cellular component. In this mode, the XBee Cellular Modem exposes all control of the cellular component's AT port through the UART.

**Note** The cellular component can become unresponsive in Bypass mode. See [Unresponsive cellular component in Bypass mode](#) for help in this situation.

---

When Bypass mode is active, most of the XBee Cellular Modem's AT commands do not work. For example, **IM** (IMEI) may never return a value, and **DB** does not update.

When entering Bypass mode, the device terminates all existing socket connections. This includes the Remote Manager connection if it is currently enabled. When leaving Bypass mode, the device re-establishes a Remote Manager connection if the Remote Manager connection setting is currently enabled.

Command mode is available while in Bypass mode; see [Enter Command mode](#) for instructions.

### Enter Bypass operating mode

To configure a device for Bypass operating mode:

1. Set the **AP** (API Mode) parameter value to 5.
2. Use **AC** (Apply Changes) or **CN** (Exit Command Mode) to apply the changes.
3. To verify that Bypass operating mode is active, query **AI** (Association Indication) and confirm that it returns a value of 0x2F.

It may take a moment for Bypass operating mode to become active.

### Leave Bypass operating mode

To configure a device to leave Bypass operating mode:

1. Set the **AP** (API Mode) parameter value to something other than 5.
2. Use **AC** (Apply Changes) or **CN** (Exit Command Mode) to apply the changes.
3. To verify that Bypass operating mode is not active, query **AI** (Association Indication) and confirm that it returns something other than 0x2F.

## Boot the XBee Cellular Modem in Bypass operating mode

If the host sends **WR** (Write) when **AP** (API Mode) is set to 5, it enables Bypass operating mode when the XBee Cellular Modem turns on. In this configuration, the firmware does not test communication with the cellular component (which it does by sending AT commands). This is useful in case you have reconfigured the cellular component in a way that makes it incompatible with the firmware.

The option to boot with Bypass operating mode enabled exists for users who wish to communicate directly with the cellular component settings and do not intend to use XBee Cellular Modem software features such as API mode.

---

**Note** When the XBee Cellular Modem has been booted with Bypass operating mode enabled, disabling Bypass operating mode causes the XBee Cellular Modem firmware to reboot the cellular modem.

---

## Restore cellular settings to default in Bypass operating mode

Send **AT&F1** to reset the cellular component to its factory profile.

## Command mode

The three operating modes are controlled by the [AP \(API Enable\)](#) setting, but Command mode is always available as a mode the device can enter while configured for any of the operating modes.

### Enter Command mode

To get a device to switch into this mode, you must issue the following sequence: **+++** within one second. There must be at least one second preceding and following the **+++** sequence. Both the command character (**CC**) and the silence before and after the sequence (**GT**) are configurable. When the device sees a full second of silence in the data stream (the guard time, **GT**) followed by the string **+++** (without Enter or Return) and another full second of silence, it knows to stop sending data and start accepting commands locally.

---

**Note** Do not press Return or Enter after typing **+++** because it will interrupt the guard time silence and prevent you from entering Command mode.

---

When the device is in Command mode, it listens for user input and is able to receive AT commands on the UART. If **CT** time (default is 10 seconds) passes without any user input, the device drops out of Command mode and returns to the previous operating mode (Transparent, Bypass, API, Python, and so forth).

You can customize the command character, the guard times and the timeout in the device's configuration settings. For more information, see [CC \(Command Sequence Character\)](#), [CT \(Command Mode Timeout\)](#) and [GT \(Guard Times\)](#).

### Troubleshooting

Failure to enter Command mode is often due to baud rate mismatch. Ensure that the baud rate of the connection matches the baud rate of the device. By default, the **BD** parameter = 3 (9600 b/s).

There are two alternative ways to enter Command mode:

- A serial break for six seconds enters Command mode. The "break" command can be issued from a serial console, and is often a button or menu item.
- Asserting DIN (serial break) upon power up or reset enters Command mode. XCTU guides you through a reset and automatically issues the break when needed.

Both of these methods temporarily set the device's baud rate to 9600 and return an **OK** on the UART to indicate that Command mode is active. When Command mode exits, the device returns to normal operation at the baud rate the **BD** parameter is set to.

### Send AT commands

Once the device enters Command mode, use the syntax in the following figure to send AT commands. Every AT command starts with the letters **AT**, which stands for "attention." The **AT** is followed by two characters that indicate which command is being issued, then by some optional configuration values. To read a parameter value stored in the device's register, omit the parameter field.

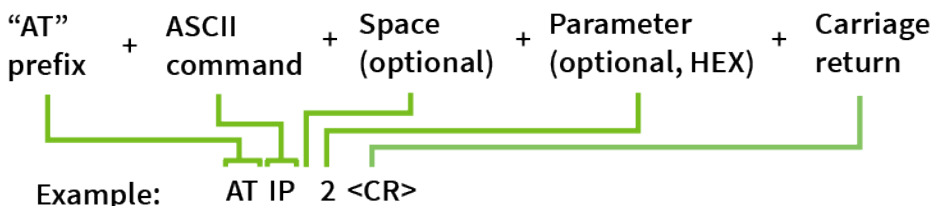

The preceding example changes the IP protocol to SMS.

### Multiple AT commands

You can send multiple AT commands at a time when they are separated by a comma in Command mode; for example, **ATSH,SL**.

### Parameter format

Refer to the list of AT commands for the format of individual AT command parameters. Valid formats for hexadecimal values include with or without a leading **0x** for example **FFFF** or **0xFFFF**.

### Response to AT commands

When reading parameters, the device returns the current parameter value instead of an **OK** message.

### Apply command changes

Any changes you make to the configuration command registers using AT commands do not take effect until you apply the changes. For example, if you send the **BD** command to change the baud rate, the actual baud rate does not change until you apply the changes. To apply changes:

1. Send the **AC** (Apply Changes) command.
- or:
2. Exit Command mode.

### Make command changes permanent

Issue a **WR (Write)** command to save the changes. WR writes parameter values to non-volatile memory so that parameter modifications persist through subsequent resets.

## Exit Command mode

1. Send the **CN** (Exit Command Mode) command followed by a carriage return.  
or:
2. If the device does not receive any valid AT commands within the time specified by **CT** (Command Mode Timeout), it returns to Transparent or API mode. The default Command Mode Timeout is 10 seconds.

For an example of programming the device using AT Commands and descriptions of each configurable parameter, see [AT commands](#).

## Sleep modes

---

About sleep modes .....	78
Normal mode .....	78
Pin sleep mode .....	78
Cyclic sleep mode .....	78
Cyclic sleep with pin wake up mode .....	78
Airplane mode .....	78
The sleep timer .....	78
MicroPython sleep behavior .....	79

## About sleep modes

A number of low-power modes exist to enable devices to operate for extended periods of time on battery power. Use [SM \(Sleep Mode\)](#) to enable these sleep modes.

### Normal mode

Set **SM** to 0 to enter Normal mode.

Normal mode is the default sleep mode. If a device is in this mode, it does not sleep and is always awake.

Devices in Normal mode are typically mains powered.

### Pin sleep mode

Set **SM** to 1 to enter pin sleep mode.

Pin sleep allows the device to sleep and wake according to the state of the SLEEP\_RQ pin (pin 9).

When you assert SLEEP\_RQ (high), the device finishes any transmit or receive operations, closes any active connection, and enters a low-power state.

When you de-assert SLEEP\_RQ (low), the device wakes from pin sleep.

### Cyclic sleep mode

Set **SM** to 4 to enter Cyclic sleep mode.

Cyclic sleep allows the device to sleep for a specific time and wake for a short time to poll.

If you use the **D7** command to enable hardware flow control, the CTS pin asserts (low) when the device wakes and can receive serial data, and de-asserts (high) when the device sleeps.

### Cyclic sleep with pin wake up mode

Set **SM** to 5 to enter Cyclic sleep with pin wake up mode.

This mode is a slight variation on Cyclic sleep mode (**SM** = 4) that allows you to wake a device prematurely by de-asserting the SLEEP\_RQ pin (pin 9).

In this mode, you can wake the device after the sleep period expires, or if a high-to-low transition occurs on the SLEEP\_RQ pin.

### Airplane mode

While not technically a sleep mode, airplane mode is another way of saving power. When set, the cellular component of the XBee Cellular Modem is fully turned off and no access to the cellular network is performed or possible. Use [AM \(Airplane Mode\)](#) to configure this mode.

### The sleep timer

If the device receives serial or RF data in Cyclic sleep mode and Cyclic sleep with pin wake up modes (**SM** = 4 or **SM** = 5), it starts a sleep timer (time until sleep).

- Use [ST \(Wake Time\)](#) to set the duration of the timer.
- When the sleep timer expires the device returns to sleep.

## MicroPython sleep behavior

When the XBee Cellular Modem enters deep sleep mode, any MicroPython code currently executing is suspended until the device comes out of sleep. When the XBee Cellular Modem comes out of sleep mode, MicroPython execution continues where it left off.

Upon entering deep sleep mode, the XBee Cellular Modem closes any active TCP/UDP connections and turns off the cellular component. As a result, any sockets that were opened in MicroPython prior to sleep report as no longer being connected. This behavior appears the same as a typical socket disconnection event will:

- **socket.send** raises **OSError: ENOTCONN**
- **socket.sendto** raises **OSError: ENOTCONN**
- **socket.recv** returns the empty string, the traditional end-of-file return value
- **socket.recvfrom** returns an empty message, for example:  
**(b'', (<address from connect(>), <port from connect(>)) )**

The underlying UDP socket resources have been released at this point.

## Serial communication

---

Serial buffers .....	81
CTS flow control .....	81
RTS flow control .....	81



## Serial buffers

The XBee Cellular Modem maintains internal buffers to collect serial and RF data that it receives. The serial receive buffer collects incoming serial characters and holds them until the device can process them. The serial transmit buffer collects the data it receives via the RF link until it transmits that data out the serial port.

---

### CTS flow control

$\overline{\text{CTS}}$  flow control is enabled by default; you can disable it with [Sets or displays the DIO7/CTS pin configuration \(pin 12\)](#). When the serial receive buffer fills with the number of bytes specified by [FT \(Flow Control Threshold\)](#), the device de-asserts  $\overline{\text{CTS}}$  (sets it high) to signal the host device to stop sending serial data. The device re-asserts  $\overline{\text{CTS}}$  when less than FT-16 bytes are in the UART receive buffer.

---

### RTS flow control

If you send [Sets or displays the DIO6/RTS pin configuration \(pin 16\)](#) to enable  $\overline{\text{RTS}}$  flow control, the device does not send data in the serial transmit buffer out the DOUT pin as long as  $\overline{\text{RTS}}$  is de-asserted (set high). Do not de-assert  $\overline{\text{RTS}}$  for long periods of time or the serial transmit buffer will fill.

## AT commands

---

MicroPython commands .....	83
Special commands .....	84
Cellular commands .....	85
Network commands .....	87
Addressing commands .....	89
Serial interfacing commands .....	92
I/O settings commands .....	94
I/O sampling commands .....	101
Command mode options .....	102
Firmware version/information commands .....	103
Diagnostic interface commands .....	104
Execution commands .....	107

## MicroPython commands

The following commands relate to using MicroPython on the XBee Cellular Modem.

### PS (Python Startup)

Sets whether or not the XBee Cellular Modem runs the stored Python code at startup.

#### Range

0 - 1

Parameter	Description
0	Do not run stored Python code at startup.
1	Run stored Python code at startup.

#### Default

0

### PY (MicroPython Command)

Interact with the XBee Cellular Modem using MicroPython. **PY** is a command with sub-commands. These sub-commands are arguments to **PY**.

#### PYC(Code Report)

You can store compiled code in flash using the **Ctrl-F** command from the MicroPython REPL; refer to the [Digi MicroPython Programming Guide](#). The **PYC** sub-command reports details of the stored code. In Command mode, it returns three lines of text, for example:

---

```
source: 1662 bytes (hash=0xC3B3A813)
bytecode: 619 bytes (hash=0x0900DBCE)
compiled: 2017-05-09T15:49:44
```

---

The messages are:

- **source**: the size of the source code used to generate the bytecode and its 32-bit hash.
- **bytecode**: the size of bytecode stored in flash and its 32-bit hash. A size of **0** indicates that there is no stored code.
- **compiled**: a compilation timestamp. A timestamp of **2000-01-01T00:00:00** indicates that the clock was not set during compilation.

In API mode, **PYC** returns five 32-bit big-endian values:

- source size
- source hash
- bytecode size
- bytecode hash
- timestamp as seconds since 2000-01-01T00:00:00

**PYD (Delete Code)**

**PYD** interrupts any running code, erases any stored code and then does a soft-reboot on the MicroPython subsystem.

**PYV (Version Report)**

Report the MicroPython version.

**PY^ (Interrupt Program)**

Sends **KeyboardInterrupt** to MicroPython. This is useful if there is a runaway MicroPython program and you have filled the stdin buffer. You can enter Command mode (**+++**) and send **ATPY^** to interrupt the program.

**Default**

N/A

## Special commands

The following commands are special commands.

**AC (Apply Changes)**

Immediately applies new settings without exiting Command mode.

Applying changes means that the device re-initializes based on changes made to its parameter values. Once changes are applied, the device immediately operates according to the new parameter values.

This behavior is in contrast to issuing the **WR** (Write) command. The **WR** command saves parameter values to non-volatile memory, but the device still operates according to previously saved values until the device is rebooted or you issue the **CN** (Exit AT Command Mode) or **AC** commands.

**Parameter range**

N/A

**Default**

N/A

**FR (Force Reset)**

Resets the device. The device responds immediately with an **OK** and performs a reset 100 ms later.

If you issue **FR** while the device is in Command Mode, the reset effectively exits command mode.

**Parameter range**

N/A

**Default**

N/A

**RE (Restore Defaults)**

Restore device parameters to factory defaults.

The **RE** command does not write restored values to non-volatile (persistent) memory. Issue the **WR** (Write) command after issuing the **RE** command to save restored parameter values to non-volatile memory.

**Parameter range**

N/A

**Default**

N/A

**WR (Write)**

Writes parameter values to non-volatile memory so that parameter modifications persist through subsequent resets.

---

**Note** Once you issue a **WR** command, do not send any additional characters to the device until after you receive the **OK** response.

---

**Parameter range**

N/A

**Default**

N/A

## Cellular commands

The following AT commands are cellular configuration and data commands.

**PH (Phone Number)**

Reads the SIM card phone number. If **PH** is blank, the XBee Cellular Modem is not registered to the network.

**Parameter range**

N/A

**Default**

Set by the cellular carrier via the SIM card

**S# (ICCID)**

Reads the Integrated Circuit Card Identifier (ICCID) of the inserted SIM.

**Parameter range**

N/A

**Default**

Set by the SIM card

## IM (IMEI)

Reads the device's International Mobile Equipment Identity (IMEI).

### Parameter range

N/A

### Default

Set in the factory

## MN (Operator)

Reads the network operator on which the device is registered.

### Parameter range

N/A

### Default

Verizon

## MV (Modem Firmware Version)

Read the firmware version string for cellular component communications. See the related [VR \(Firmware Version\)](#) command.

### Parameter range

N/A

### Default

Set in the currently loaded firmware

## DB (Cellular Signal Strength)

Reads the absolute value of the current signal strength to the cell tower in dB. If DB is blank, the XBee Cellular Modem has not received a signal strength from the cellular component.

### Parameter range

0x71 - 0x33 (-113 dBm to -51 dBm) [read-only]

### Default

N/A

## AM (Airplane Mode)

When set, the cellular component of the XBee Cellular Modem is fully turned off and no access to the cellular network is performed or possible.

### Parameter range

0 - 1

0 = Normal operation

1 = Airplane mode

**Default**

0

**DV (Antenna Diversity)**

Set and read the antenna diversity setting of the cellular component. When enabled, the cellular component uses both antennas to improve receive sensitivity.

This setting is applied only while the XBee Cellular Modem is initializing the cellular component. After changing this setting, you must:

1. Use [WR \(Write\)](#) to write all values to flash.
2. Use [FR \(Force Reset\)](#) to reset the device.
3. Wait for the cellular component to be initialized: [AI \(Association Indication\)](#) reaches **0x00**.
4. Use **FR** to reset the device a second time.
5. Wait again for the cellular component to initialize: **AI** reaches **0x00**.

**Parameter range**

0 - 1

0 - diversity disabled

1 - diversity enabled

**Default**

1

**Network commands**

The following commands are network commands.

**IP (IP Protocol)**

Sets or displays the IP protocol used for client and server socket connections in IP socket mode.

**Parameter range**

Value	Description
0x00	UDP
0x01	TCP
0x02	SMS
0x03	Reserved
0x04	SSL over TCP communication

**Default**

0x01

### TL (SSL/TLS Protocol Version)

Sets the SSL/TLS protocol version used for the SSL socket. If you change the **TL** value, it does not affect any currently open sockets. The value only applies to subsequently opened sockets.

**Note** Due to known vulnerabilities in prior protocol versions, we strongly recommend that you use the latest TLS version whenever possible.

#### Range

Value	Description
0x00	SSL v3
0x01	TLS v1.0
0x02	TLS v1.1
0x03	TLS v1.2

#### Default

0x03

### TM (TCP Client Connection Timeout)

Sets or reads the TCP client connection timeout. If there is no activity for this timeout then the connection is closed. If you set **TM** to 0, the connection is closed immediately after the device sends data.

If you change the **TM** value while in Transparent Mode, the current connection is immediately closed. Upon the next transmission, the **TM** value applies to the newly created socket.

If you change the **TM** value while in API Mode, the value only applies to subsequently opened sockets.

#### Parameter range

0 - 0xFFFF [x 100 ms]

#### Default

0xBB8 (5 minutes)

### DO (Device Options)

Sets or displays whether Remote Manager support is enabled.

#### Bit 0

If the XBee Cellular Modem cannot establish a connection with Remote Manager , it waits 30 seconds before trying again. On each successive connection failure, the wait time doubles (60 seconds, 120, 240, and so on) up to a maximum of 1 hour. This time resets to 30 seconds once the connection to Remote Manager succeeds or if the device is reset.

#### Bits 1 - 7

Reserved



**Range**

Value	Description
0x00	Disable Remote Manager support.
0x01	Enable Remote Manager support.

**Default**

0x01

**EQ (Device Cloud FQDN)**

Sets or display the fully qualified domain name of the Remote Manager server.

**Range**

From 0 through 63 ASCII characters.

**Default**

**my.devicecloud.com**

## Addressing commands

The following AT commands are addressing commands.

**SH (Serial Number High)**

The upper digits of the unique International Mobile Equipment Identity (IMEI) assigned to this device.

**Parameter range****Default**

N/A

**SL (Serial Number Low)**

The lower digits of the unique International Mobile Equipment Identity (IMEI) assigned to this device.

**Parameter range****Default**

N/A

**DL (Destination Address)**

The destination IPv4 address or fully qualified domain name.

To set the destination address to an IP address, the value must be a dotted quad, for example **XXX.XXX.XXX.XXX**.

To set the destination address to a domain name, the value must be a legal Internet host name, for example **remotemanager.digi.com**

**Parameter range**

0 - 128 ASCII characters

**Default**

0.0.0.0

**P# (Destination Phone Number)**

Sets or displays the destination phone number used for SMS when **IP** (IP Protocol) = 2. Phone numbers must be fully numeric, 7 to 20 ASCII digits, for example: 8889991234.

**P#** allows international numbers with or without the **+** prefix. If you omit **+** and are dialing internationally, you need to include the proper International Dialing Prefix for your calling region, for example, 011 for the United States.

**Range**

7 - 20 ASCII digits including an optional **+** prefix

**Default**

N/A

**DE (Destination Port)**

Sets or reads the destination IP port number.

**Parameter range**

0x0 - 0xFFFF

**Default**

0x2616

**TD (Text Delimiter)**

The ASCII character used as a text delimiter for Transparent mode. When you select a character, information received over the serial port in Transparent mode is not transmitted until that character is received. To use a carriage return, set to 0xD. Set to zero to disable text delimiter checking.

**Parameter range**

0 - 0xFF

**Default**

0x0

**MY (Module IP Address)**

Reads the device's IP address. This command is read-only because the IP address is assigned by the mobile network.

In API mode, the address is represented as the binary four byte big-endian numeric value representing the IPv4 address.

In Transparent or Command mode, the address is represented as a dotted-quad string notation.

**Parameter range**

0- 15 IPv4 characters

**Default**

0.0.0.0

**LA (Lookup IP Address of FQDN)**

Performs a DNS lookup of the given fully qualified domain name (FQDN) and outputs its IP address.

When you issue the command in API mode, the IP address is formatted in binary. In all other cases (for example, Command mode) the format is dotted decimal notation.

**Range**

Valid FQDN.

**Default**

-

**OD (Operating Destination Address)**

Read the destination IPv4 address currently in use by Transparent mode. The value is 0.0.0.0 if no Transparent IP connection is active.

In API mode, the address is represented as the binary four byte big-endian numeric value representing the IPv4 address.

In Transparent or Command mode, the address is represented as a dotted-quad string notation.

**Parameter range**

-

**Default**

0.0.0.0

**C0 (Source Port)**

Set or get the port number used to provide the serial communication service. Data received by this port on the network is transmitted on the XBee Cellular Modem's serial port. As long as a network connection is established to this port (for TCP) data received on the serial port is transmitted on the established network connection.

[IP \(IP Protocol\)](#) sets the protocol used when UART is in Transparent mode.

**Parameter range**

0 - 0xFFFF

Value	Description
0	Disabled
Non-0	Enabled on that port

**Default**

0

## Serial interfacing commands

The following AT commands are serial interfacing commands.

### BD (Baud Rate)

Sets or reads the serial interface baud rate for communication between the device's serial port and the host.

**Parameter range**

0x0 - 0xA (standard rates) 0x5B9 to 0x5B8D80 (non-standard rates up to 6 Mb/s)

Parameter	Description
0x0	1200 b/s
0x1	2400 b/s
0x2	4800 b/s
0x3	9600 b/s
0x4	19200 b/s
0x5	38400 b/s
0x6	57600 b/s
0x7	115200 b/s
0x8	230400 b/s
0x9	460800 b/s
0xA	921600 b/s

**Default**

3 (9600 b/s)

### NB (Parity)

Set or read the serial parity settings for UART communications.

**Parameter range**

0x00 - 0x02

Parameter	Description
0x00	No parity

Parameter	Description
0x01	Even parity
0x02	Odd parity

**Default**

0x00

**SB (Stop Bits)**

Sets or reads the number of stop bits for UART communications.

**Parameter range**

0x00 - 0x01

Parameter	Configuration
0x00	One stop bit
0x01	Two stop bits

**Default**

0x00

**RO (Packetization Timeout)**

Set or read the number of character times of inter-character silence required before transmission begins when operating in Transparent mode.

Set **RO** to 0 to transmit characters as they arrive instead of buffering them into one RF packet.

Set to FF for realtime typing by humans. Also, see [TD \(Text Delimiter\)](#).

**Parameter range**

0 - 0xFF (x character times)

**Default**

3

**FT (Flow Control Threshold)**

Set or display the flow control threshold.

The device de-asserts  $\overline{\text{CTS}}$  when **FT** bytes are in the UART receive buffer.

**Parameter range**

0x9D - 0x82D

**Default**

0x681

## AP (API Enable)

The API mode setting. The device can format the RF packets it receives into API frames and send them out the UART. When API is enabled the UART data must be formatted as API frames because Transparent mode is disabled. See [Modes](#) for more information.

### Parameter range

0x00 - 0x05

Parameter	Description
0x00	API disabled (operate in Transparent mode)
0x01	API enabled
0x02	API enabled (with escaped control characters)
0x03	N/A
0x04	MicroPython REPL
0x05	Bypass mode

### Default

0

## I/O settings commands

The following AT commands are I/O settings commands.

### DO (DIO0/AD0)

The DIO0/AD0 pin configuration (pin 20).

### Parameter range

0, 2 - 5

Parameter	Description
0	Disabled
1	N/A
2	Analog input
3	Digital input
4	Digital output, default low
5	Digital output, default high

### Default

1

**D1 (DIO1/AD1)**

The DIO1/AD1 pin configuration (pin 19).

**Parameter range**

0, 2 - 5

Parameter	Description
0	Disabled
1	N/A
2	ADC
3	Digital input
4	Digital output, low
5	Digital output, high

**Default**

0

**D2 (DIO2/AD2)**

The DIO2/AD2 pin configuration (pin 18).

**Parameter range**

0, 2 - 5

Parameter	Description
0	Disabled
1	N/A
2	Analog input
3	Digital input
4	Digital output, default low
5	Digital output, default high

**Default**

0

**D3 (DIO3/AD3)**

The DIO3/AD3 pin configuration (pin 17).

**Parameter range**

0, 2 - 5

Parameter	Description
0	Disabled
1	N/A
2	Analog input
3	Digital input
4	Digital output, default low
5	Digital output, default high

**Default**

0

**D4 (DIO4)**

The DIO4 pin configuration (pin 11).

**Parameter range**

0, 3 - 5

Parameter	Description
0	Disabled
1	N/A
2	N/A
3	Digital input
4	Digital output, default low
5	Digital output, default high

**Default**

0

**D5 (DIO5/ASSOCIATED\_INDICATOR)**

The DIO5/ASSOCIATED\_INDICATOR pin configuration (pin 15).

**Parameter range**

0, 1, 3-5

Parameter	Description
0	Disabled
1	Associated LED



Parameter	Description
2	N/A
3	Digital input
4	Digital output, default low
5	Digital output, default high

**Default**

1

Sets or displays the DIO6/ $\overline{\text{RTS}}$  pin configuration (pin 16).**Parameter range**

0 - 1

**Default**

0

Sets or displays the DIO7/ $\overline{\text{CTS}}$  pin configuration (pin 12).**Parameter range**

0 - 1

**Default**

0x1

**D8 (DIO8/SLEEP\_REQUEST)**Set or read the DIO8/ $\overline{\text{DTR}}$ /SLP\_RQ pin configuration (pin 9).**Parameter range**

0, 1, 3-5

Parameter	Description
0	Disabled
1	SLEEP_REQUEST input
3	Reserved
4	Reserved
5	Reserved

**Default**

1

**D9 (DIO9/ON\_SLEEP)**

The DIO9/ON\_SLEEP pin configuration (pin 13).

**Parameter range**

0, 1, 3 - 5

Parameter	Description
0	Disabled
1	ON/SLEEP output
3	Reserved
4	Reserved
5	Reserved

**Default**

1

**P0 (DIO10 Configuration)**

The DIO10 pin configuration.

**Parameter range**

0, 3 - 5

Parameter	Description
0	Disabled
1	N/A
2	N/A
3	Digital input
4	Digital output, default low
5	Digital output, default high

**Default**

0

**P1 (DIO11/PWM1 Configuration)**

The DIO11/PWM1 pin configuration (pin 7).

**Parameter range**

0, 1, 3-5

Parameter	Description
0	Disabled
1	Fan enable. Output is low when the XBee Cellular Modem is sleeping, turning an attached fan off when the cellular component is in a power saving mode, and also during Airplane Mode
3	Reserved
4	Reserved
5	Reserved

**Default**

0

**P2 (DIO12 Configuration)**

The DIO12 pin configuration (pin 4).

**Parameter range**

0, 3 - 5

Parameter	Description
0	Disabled
1	N/A
2	N/A
3	Digital input
4	Digital output, default low
5	Digital output, default high

**Default**

0

**PD (Pull Direction)**

The resistor pull direction bit field (**1** = pull-up, **0** = pull-down) for corresponding I/O lines that are set by [PR \(Pull-up/down Resistor Enable\)](#).

If the bit is not set in **PR**, the device uses **PD**.

---

**Note** Resistors are not applied to disabled lines.

---

See [PR \(Pull-up/down Resistor Enable\)](#) for bit mappings, which are the same.

**Parameter range**

0x0 – 0x7FFF

**Default**

0 – 0x7FFF

**PR (Pull-up/down Resistor Enable)**

Sets or reads the bit field that configures the internal resistor status for the digital input lines. Internal pull-up/down resistors are not available for digital output pins, analog input pins, or for disabled pins.

Use the **PD** command to specify whether the resistor is pull-up or pull-down.

- If you set a **PR** bit to 1, it enables the pull-up/down resistor
- If you set a **PR** bit to 0, it specifies no internal pull-up/down resistor.

The following table defines the bit-field map for both the **PR** and **PD** commands.

Bit	I/O line	Module pin
0	DIO4	pin 11
1	DIO3/AD3	pin 17
2	DIO2/AD2	pin 18
3	DIO1/AD1	pin 19
4	DIO0/AD0	pin 20
5	DIO6/ $\overline{\text{RTS}}$	pin 16
6	DIO8/SLEEP_REQUEST	pin 9
7	DIO14/DIN	pin 3
8	DIO5/ASSOCIATE	pin 15
9	DIO9/On/ $\overline{\text{SLEEP}}$	pin 13
10	DIO12	pin 4
11	DIO10	pin 6
12	DIO11	pin 7
13	DIO7/ $\overline{\text{CTS}}$	pin 12
14	DIO13/DOUT	pin 2

**Parameter range**

0 - 0x7FFF (bit field)

**Default**

0x7FFF

## I/O sampling commands

### TP (Temperature)

Displays the temperature of the XBee in degrees Celsius. The temperature value is displayed in 8-bit two's complement format. For example, **0x1A** = 26°C, and **0xF6** = -10°C.

#### Parameter range

0 - 0xFF which indicates degrees Celsius displayed in 8-bit two's complement format.

#### Default

N/A

### SM (Sleep Mode)

Sets or reads the sleep mode of the device.

The sleep mode determines how the device enters and exits a power saving sleep.

Sleep mode is also affected by the **SO** command, option bit 6. See [Sleep modes](#) for more information about sleep modes.

#### Parameter range

0, 1, 4, 5

Parameter	Description
0	Normal. In this mode the device never sleeps.
1	Pin Sleep. In this mode the device honors the SLEEP_RQ pin. Set <b>D8 (DIO8/SLEEP_REQUEST)</b> to the sleep request function: <b>1</b> .
4	Cyclic Sleep. In this mode the device repeatedly sleeps for the value specified by <b>SP</b> and spends <b>ST</b> time awake.
5	Cyclic Sleep with Pin Wake. In this mode the device acts as in Cyclic Sleep but does not sleep if the SLEEP_RQ pin is inactive, allowing the device to be kept awake or woken by the connected system.

#### Default

0

### SP (Sleep Period)

Sets or reads the time to spend asleep in cyclic sleep modes. In Cyclic sleep mode, the node sleeps with CTS disabled for the sleep time interval, then wakes for the wake time interval.

#### Parameter range

0x1 - 0x83D600 (x 10 ms)

#### Default

0x7530 (5 minutes)

## ST (Wake Time)

Sets or reads the time to spend awake in cyclic sleep modes.

### Parameter range

0x1 - 0x36EE80 (x 1 ms)

### Default

0xEA60 (60 seconds)

## Command mode options

The following commands are Command mode option commands.

## CC (Command Sequence Character)

The character value the device uses to enter Command mode.

The default value (0x2B) is the ASCII code for the plus (+) character. You must enter it three times within the guard time to enter Command mode. To enter Command mode, there is also a required period of silence before and after the command sequence characters of the Command mode sequence (**GT + CC + GT**). The period of silence prevents inadvertently entering Command mode.

### Parameter range

0 - 0xFF

Recommended: 0x20 - 0x7F (ASCII)

### Default

0x2B (ASCII + character)

## CT (Command Mode Timeout)

Sets or reads the Command mode timeout parameter. If a device does not receive any valid commands within this time period, it returns to Idle mode from Command mode.

### Parameter range

2 - 0x1770 (x 100 ms)

### Default

0x64 (10 seconds)

## GT (Guard Times)

Set the required period of silence before and after the command sequence characters of the Command mode sequence (**GT + CC + GT**). The period of silence prevents inadvertently entering Command mode.

### Parameter range

0x2 - 0x576 (x 1 ms)

### Default

0x3E8 (one second)

## Firmware version/information commands

The following AT commands are firmware version/information commands.

### VR (Firmware Version)

Reads the firmware version on a device.

The firmware version returns four hexadecimal values (2 bytes) **ABCD**. Digits **ABC** are the main release number and **D** is the revision number from the main release. **B** is a variant designator where **0** means standard release.

#### Parameter range

0 - 0xFFFF [read-only]

#### Default

Set in firmware

### VL (Version Long)

Shows detailed version information including the application build date and time.

#### Parameter range

N/A

#### Default

Set in firmware

### HV (Hardware Version)

Display the hardware version number of the device.

Read the device's hardware version. Use this command to distinguish between different hardware platforms. The upper byte returns a value that is unique to each device type. The lower byte indicates the hardware revision.

#### Parameter range

0 - 0xFFFF [read-only]

#### Default

Set in the factory

### AI (Association Indication)

Reads the Association status code to monitor association progress. The following table provides the status codes and their meanings.

Status code	Meaning
0x00	Connected to the Internet.

Status code	Meaning
0x22	Registering to cellular network.
0x23	Connecting to the Internet.
0x24	The cellular component is missing, corrupt, or otherwise in error. The cellular component requires a new firmware image.
0x2A	Airplane mode.
0x2F	Bypass mode active.
0xFF	Initializing.

**Parameter range**

0 - 0xFF [read-only]

**Default**

N/A

**HS (Hardware Series)**

Read the device's hardware series number.

**Parameter range**

N/A

**Default**

Set in the factory

**CK (Configuration CRC)**

Displays the cyclic redundancy check (CRC) of the current AT command configuration settings.

**Parameter range**

0 - 0xFFFFFFFF

**Default**

N/A

**Diagnostic interface commands**

The following AT commands are diagnostic interface commands.

**DI (Device Cloud Indicator)**

Displays the current Remote Manager status for the XBee.



**Range**

Value	Description
0x00	Connected
0x01	Before connection to the Internet
0x02	Remote Manager connection in progress
0x03	Disconnecting from Remote Manager
0x04	Not configured for Remote Manager

**Default**

N/A

**CI (Protocol/Connection Indication)**

Displays information regarding the last IP connection (when the **IP** command = 0, 1 or 4) or SMS transmission (when **IP** = 2).

The value for this parameter resets to **0xFF** when the device switches between **IP (IP Protocol)** modes.

When **IP** is set to **0, 1, or 4** (UDP, TCP, over SSL over TCP), **CI** resets to **0xFF** when you apply changes to any of the following settings:

- **DL (Destination Address)**
- **DE (Destination Port)**
- **TM (TCP Client Connection Timeout)**

When **IP** is set to **2** (SMS), **CI** resets to **0xFF** when **P# (Destination Phone Number)** is changed.

The following table provides the parameter's meaning when **IP** = 0 for UDP connections.

Parameter	Description
0x00	The socket is open.
0x01	Tried to send but could not.
0x02	Invalid parameters (bad IP/host).
0x03	TCP not supported on this cellular component.
0x10	Not registered to the cell network.
0x11	Cellular component not identified yet.
0x12	DNS query lookup failure.
0x20	Bad handle.
0x21	User closed.
0x22	Unknown server - DNS lookup failed .

Parameter	Description
0x23	Connection lost.
0x24	Unknown.
0xFF	No known status.

The following table provides the parameter's meaning when **IP** = 1 or 4 for TCP connections.

Parameter	Description
0x00	The socket is open.
0x01	Tried to send but could not.
0x02	Invalid parameters (bad IP/host).
0x03	TCP not supported on this cellular component.
0x10	Not registered to the cell network.
0x11	Cellular component not identified yet.
0x12	DNS query lookup failure.
0x20	Bad handle.
0x21	User closed.
0x22	No network registration.
0x23	No internet connection.
0x24	No server - timed out on connection .
0x25	Unknown server - DNS lookup failed .
0x26	Connection refused.
0x27	Connection lost.
0x28	Unknown.
0xFF	No known status.

The following table provides the parameter's meaning when **IP** = 2 for SMS connections.

Parameter	Description
0x00	SMS successfully sent.
0x01	SMS failed to send.
0x02	Invalid SMS parameters - check <a href="#">P# (Destination Phone Number)</a> .
0x03	SMS not supported.

Parameter	Description
0x10	No network registration.
0x11	Cellular component stack error.
0xFF	No SMS state to report (no SMS messages have been sent).

**Parameter range**

0 - 0xFF (read-only)

**Default**

-

## Execution commands

The location where most AT commands set or query register values, execution commands execute an action on the device. Execution commands are executed immediately and do not require changes to be applied.

### AN (APN)

Sets or reads the Access Point Name (APN) the device uses to connect. The APN must match a valid value for the carrier.



**CAUTION!** Send **ATNR0** to reset Internet connectivity any time that you change **AN**. Failure to do so can cause usability problems with the XBee Cellular Modem.

If **AN** runs with no value, the command responds with a cached copy of the active APN value. When the XBee Cellular Modem is turned on, this value is empty and is queried from the cellular component settings and is cached once per minute.

If **AN** runs with a value, the XBee Cellular Modem holds that value in memory until the next time Internet connectivity is established.

**AN** is not case sensitive. **AN** may return an APN that matches everything except the case; this is acceptable and is not an error.

Some common APN values are:

Value	Description
WYLESLTE.GW7.VZWENTP	KORE SIMS in the evaluation kit
VZWINTERNET	Standard Verizon SIMS

**Parameter range**

0 - 99 ASCII characters

**Default**

-

## NR (Network Reset)

**Note** **NR** and **NRO** both perform the same function and may be used interchangeably.

**NR** resets the network layer parameters.

The XBee Cellular Modem responds immediately with an **OK** on the UART and then causes a network restart.

If **NR** = 0, the XBee Cellular Modem tears down any TCP/UDP sockets and resets Internet connectivity. You can also send **NR**, which acts like **NR** = 0.

### Parameter range

0

### Default

N/A

## !R (Modem Reset)

Forces the cellular component to reboot.



**CAUTION!** This command is for advanced users, and you should only use it if the cellular component becomes completely stuck while in Bypass mode. Normal users should never need to run this command. See the [FR \(Force Reset\)](#) command instead.

### Range

N/A

### Default

N/A

## IS (Force Sample)

When run, **IS** reports the values of all of the enabled digital and analog input lines. If no lines are enabled for digital or analog input, the command returns an error.

### Command mode

In Command mode, the response value is a multi-line format, individual lines are delimited with carriage returns, and the entire response terminates with two carriage returns. Each line is a series of ASCII characters representing a single number in hexadecimal notation. The interpretation of the lines is:

- Number of samples. For legacy reasons this field always returns 1.
- Digital channel mask. A bit-mask of all I/O capable pins in the system. The bits set to **1** are configured for digital I/O and are included in the digital data value below. Pins D0 - D9 are bits 0 - 9, and P0 - P2 are bits 10 - 12.
- Analog channel mask. The bits set to **1** are configured for analog I/O and have individual readings following the digital data field.

- Digital data. The current digital value of all the pins set in the digital channel mask, only present if at least one bit is set in the digital channel mask.
- Analog data. Additional lines, one for each set pin in the analog channel mask. Each reading is a 10-bit ADC value for a 2.5 V voltage reference.

### API operating mode

In API operating mode, **IS** immediately returns an **OK** response.

The API response is ordered identical to the Command mode response with the same fields present. Each field is a binary number of the size listed in the following table. Multi-byte fields are in big-endian byte order.

Field	Size
Number of samples	1 byte
Digital channel mask	2 bytes
Analog channel mask	1 byte
Samples	2 bytes each

### Parameter range

N/A

### Default

N/A

## Operate in API mode

---

API frame specifications .....	111
Calculate and verify checksums .....	113
Frame descriptions .....	114

## API frame specifications

The firmware supports two API operating modes: without escaped characters and with escaped characters. Use the **AP** command to enable either mode. To configure a device to one of these modes, set the following **AP** parameter values:

AP command setting	Description
<b>AP = 0</b>	Transparent operating mode, UART serial line replacement with API modes disabled. This is the default option.
<b>AP = 1</b>	API operation.
<b>AP = 2</b>	API operation with escaped characters (only possible on UART).
<b>AP = 3</b>	Reserved, do not use.
<b>AP = 4</b>	Reserved, do not use.
<b>AP = 5</b>	Bypass mode. This mode is for direct communication with the underlying chip and is only for advanced users.

The API data frame structure differs depending on what mode you choose.

The firmware silently discards any data it receives prior to the start delimiter. If the device does not receive the frame correctly or if the checksum fails, the device discards the frame.

### API operation (AP parameter = 1)

We recommend this API mode for most applications. The following table shows the data frame structure when you enable this mode:

Frame fields	Byte	Description
Start delimiter	1	0x7E
Length	2 - 3	Most Significant Byte, Least Significant Byte
Frame data	4 - n	API-specific structure
Checksum	n + 1	1 byte

### API operation-with escaped characters (AP parameter = 2)

Set API to 2 to allow escaped control characters in the API frame. Due to its increased complexity, we only recommend this API mode in specific circumstances. API 2 may help improve reliability if the serial interface to the device is unstable or malformed frames are frequently being generated.

When operating in API 2, if an unescaped 0x7E byte is observed, it is treated as the start of a new API frame and all data received prior to this delimiter is silently discarded. For more information on using this API mode, refer to the following knowledge base article:

[http://knowledge.digi.com/articles/Knowledge\\_Base\\_Article/Escaped-Characters-and-API-Mode-2](http://knowledge.digi.com/articles/Knowledge_Base_Article/Escaped-Characters-and-API-Mode-2)

The following table shows the structure of an API frame with escaped characters:

Frame fields	Byte	Description	
Start delimiter	1	0x7E	
Length	2 - 3	Most Significant Byte, Least Significant Byte	Characters escaped if needed
Frame data	4 - n	API-specific structure	
Checksum	n + 1	1 byte	

### Escape characters

When sending or receiving a UART data frame, you must escape (flag) specific data values so they do not interfere with the data frame sequencing. To escape an interfering data byte, insert 0x7D and follow it with the byte to be escaped XOR'd with 0x20. If not escaped, 0x11 and 0x13 are sent as is.

Data bytes that need to be escaped:

- 0x7E – Frame delimiter
- 0x7D – Escape
- 0x11 – XON
- 0x13 – XOFF

**Example** - Raw UART data frame (before escaping interfering bytes): 0x7E 0x00 0x02 0x23 0x11 0xCB  
0x11 needs to be escaped which results in the following frame: 0x7E 0x00 0x02 0x23 0x7D 0x31 0xCB

**Note** In the previous example, the length of the raw data (excluding the checksum) is 0x0002 and the checksum of the non-escaped data (excluding frame delimiter and length) is calculated as:  
 $0xFF - (0x23 + 0x11) = (0xFF - 0x34) = 0xCB$ .

### Start delimiter

This field indicates the beginning of a frame. It is always 0x7E. This allows the device to easily detect a new incoming frame.

### Length

The length field specifies the total number of bytes included in the frame's data field. Its two-byte value excludes the start delimiter, the length, and the checksum.

### Frame data

This field contains the information that a device receives or will transmit. The structure of frame data depends on the purpose of the API frame:

Start delimiter	Length		Frame data								Checksum
			Frame type	Data							
1	2	3	4	5	6	7	8	9	...	n	n+1
0x7E	MSB	LSB	API frame type	Data							Single byte



- **Frame type** is the API frame type identifier. It determines the type of API frame and indicates how the Data field organizes the information.
- **Data** contains the data itself. This information and its order depend on the what type of frame that the Frame type field defines.

## Checksum

Checksum is the last byte of the frame and helps test data integrity. It is calculated by taking the hash sum of all the API frame bytes that came before it, except the first three bytes (start delimiter and length).

## Calculate and verify checksums

To calculate the checksum of an API frame:

1. Add all bytes of the packet, except the start delimiter 0x7E and the length (the second and third bytes).
2. Keep only the lowest 8 bits from the result.
3. Subtract this quantity from 0xFF.

To verify the checksum of an API frame:

1. Add all bytes including the checksum; do not include the delimiter and length.
2. If the checksum is correct, the last two digits on the far right of the sum equal 0xFF.

## Frame descriptions

The following sections describe the API frames.

### AT Command - 0x08

#### **Description**

Use this frame to query or set parameters on the local device. Changes this frame makes to device parameters take effect after executing the AT command.

#### **Format**

The following table provides the contents of the frame. For details on frame structure, see [API frame specifications](#).

Field name	Field value	Data type	Description
Frame type	0x08	Byte	
Frame ID		Byte	Identifies the data frame for the host to correlate with a subsequent ACK. If set to <b>0</b> , the device does not send a response.
AT command		Byte	Command name: two ASCII characters that identify the AT command.
Parameter value		Byte	If present, indicates the requested parameter value to set the given register. If no characters are present, it queries the register.

## AT Command: Queue Parameter Value - 0x09

### Description

This frame allows you to query or set device parameters. In contrast to [AT Command - 0x08](#), this frame queues new parameter values and does not apply them until you issue either:

- The AT Command (0x08) frame
- The **AC** command

When querying parameter values, the 0x09 frame behaves identically to the 0x08 frame. The device returns register queries immediately and does not queue them. The response for this command is also an AT Command Response frame (0x88).

### Format

The following table provides the contents of the frame. For details on frame structure, see [API frame specifications](#).

Field name	Field value	Data type	Description
Frame type	0x09	Byte	
Frame ID		Byte	Identifies the data frame for the host to correlate with a subsequent ACK. If set to <b>0</b> , the device does not send a response.
AT command		Byte	Command name: two ASCII characters that identify the AT command.
Parameter value		Byte	If present, indicates the requested parameter value to set the given register. If no characters are present, it queries the register.

## Transmit (TX) SMS - 0x1F

### Description

Transmit an SMS message. The frame allows international numbers with or without the + prefix. If you omit + and are dialing internationally, you need to include the proper International Dialing Prefix for your calling region, for example, 011 for the United States.

### Format

The following table provides the contents of the frame. For details on frame structure, see [API frame specifications](#).

Field name	Field value	Data type	Description
Frame type	0x1F	Byte	
Frame ID		Byte	Reference identifier used to match status responses. Zero disables the TX Status frame.
Options		Byte	Reserved for future use.
Phone number		20 byte string	String representation of phone number terminated with a null (0x0) byte. Use numbers and the + symbol only, no other symbols or letters.
Payload		Variable (160 characters maximum)	Data to send as the body of the SMS message.

## Transmit (TX) Request: IPv4 - 0x20

### Description

A TX Request message causes the device to transmit data in IPv4 format.

### Format

The following table provides the contents of the frame. For details on frame structure, see [API frame specifications](#).

Field name	Field value	Data type	Description
Frame type	0x20	Byte	
Frame ID		Byte	Reference identifier used to match status responses. <b>0</b> disables the TX Status frame.
Destination address		32-bit big endian	
Destination port		16-bit big endian	
Source port		16-bit big endian	UDP or TCP port number. To send a UDP packet, this must match the port number of the listening port. To send a TCP packet on a new connection, this must be <b>0</b> .
Protocol		Byte	0 = UDP 1 = TCP 4 = SSL over TCP
Transmit options		Byte bitfield	Bit fields are offset 0 Bit field 0 - 7. Bits 0, and 2-7 are reserved, bit 1 is not. BIT 1 = <b>1</b> - Terminate the TCP socket after transmission is complete <b>0</b> - Leave the socket open (use TCP timeout) Ignore this bit for UDP packets. All other bits are reserved and should be <b>0</b> .
Payload		Variable	Data to be transferred to the destination, may be up to 1500 bytes.

## AT Command Response - 0x88

### Description

A device sends this frame in response to an AT Command (0x08) frame. Some commands send back multiple frames.

### Format

The following table provides the contents of the frame. For details on frame structure, see [API frame specifications](#).

Field name	Field value	Data type	Description
Frame type	0x88	Byte	
Frame ID		Byte	Identifies the data frame for the host to correlate with a subsequent ACK. If set to <b>0</b> , the device does not send a response.
AT command		Byte	Command name: two ASCII characters that identify the AT command.
Status	##	Byte	0 = OK 1 = ERROR 2 = Invalid command 3 = Invalid parameter
Parameter value		Byte	Register data in binary format. If the register was set, then this field is not returned.

## Transmit (TX) Status - 0x89

### Description

Indicates the success or failure of a transmit operation.

### Format

The following table provides the contents of the frame. For details on frame structure, see [API frame specifications](#).

Field name	Field value	Data type	Description
Frame type	0x89	Byte	
Frame ID		Byte	Refers to the frame ID specified in a previous transmit frame
Status		Byte	Status code (see the table below)

The following table shows the SMS status codes.

Code	Description
0x0	Successful transmit
0x21	Failure to transmit to cell network
0x22	Not registered to cell network
0x2c	Invalid frame values (check the phone number)
0x31	Internal error
0x32	Resource error (retry operation later)
0x74	Message too long
0x78	Invalid UDP port
0x79	Invalid TCP port
0x7A	Invalid host address
0x7B	Invalid data mode
0x80	Connection refused
0x81	Socket connection lost
0x82	No server
0x83	Socket closed
0x84	Unknown server
0x85	Unknown error

## Modem Status - 0x8A

### Description

Cellular component status messages are sent from the device in response to specific conditions.

### Format

The following table provides the contents of the frame. For details on frame structure, see [API frame specifications](#).

Field name	Field value	Data type	Description
Frame type	0x8A	Byte	
Status	##	Byte	0 = Hardware reset or power up 1 = Watchdog timer reset 2 = Registered with cellular network 3 = Unregistered with cellular network 0x0E = Remote Manager connected 0x0F = Remote Manager disconnected



## Receive (RX) Packet: SMS - 0x9F

### Description

This XBee Cellular Modem uses this frame when it receives an SMS message.

### Format

The following table provides the contents of the frame. For details on frame structure, see [API frame specifications](#).

Field name	Field value	Data type	Description
Frame Type	0x9F	Byte	
Phone number		20 byte string	String representation of the phone number, padded out with null bytes (0x0).
Payload		Variable	Body of the received SMS message.

## Receive (RX) Packet: IPv4 - 0xB0

### Description

The XBee Cellular Modem uses this frame when it receives RF data on the port defined by the [C0 \(Source Port\)](#) command.

### Format

The following table provides the contents of the frame. For details on frame structure, see [API frame specifications](#).

Field name	Field value	Data type	Description
Frame type	0xB0	Byte	
Source address		32-bit big endian	
Destination port		16-bit big endian	
Source port		16-bit big endian	
Protocol		Byte	0 = UDP 1 = TCP 4 = SSL over TCP
Status		Byte	Reserved
Payload		Variable	Data received from the source. The maximum size is 1500 bytes.

## Socket behavior

---

Secure Sockets Layer (SSL) certificate checking .....	124
Socket timeouts .....	124

## Secure Sockets Layer (SSL) certificate checking

Currently, the XBee Cellular Modem is not capable of checking the certificate of the remote end of the socket connection. We will add this support in the future.

This means that the device cannot authenticate the remote end of the connection. Although the connection is encrypted, there is no way to verify that the remote server is the expected server.

## Socket timeouts

The XBee Cellular Modem implicitly opens the socket any time there is data to be sent, and closes it according to the timeout settings. The [TM \(TCP Client Connection Timeout\)](#) command controls the timeout settings.

## Troubleshooting

---

This section contains troubleshooting steps for the XBee Cellular Modem.

Cannot find the serial port for the device .....	126
Correct a macOS Java error .....	128
Unresponsive cellular component in Bypass mode .....	129
Not on expected network after APN change .....	130
Syntax error at line 1 .....	130
Error Failed to send SMS .....	130

## Cannot find the serial port for the device

### Condition

In XCTU, the serial port that your device is connected to does not appear.

### Solution

1. Click the **Discover radio modules** button .
2. Select all of the ports to be scanned.
3. Click **Next** and then **Finish**. A dialog notifies you of the devices discovered and their details.

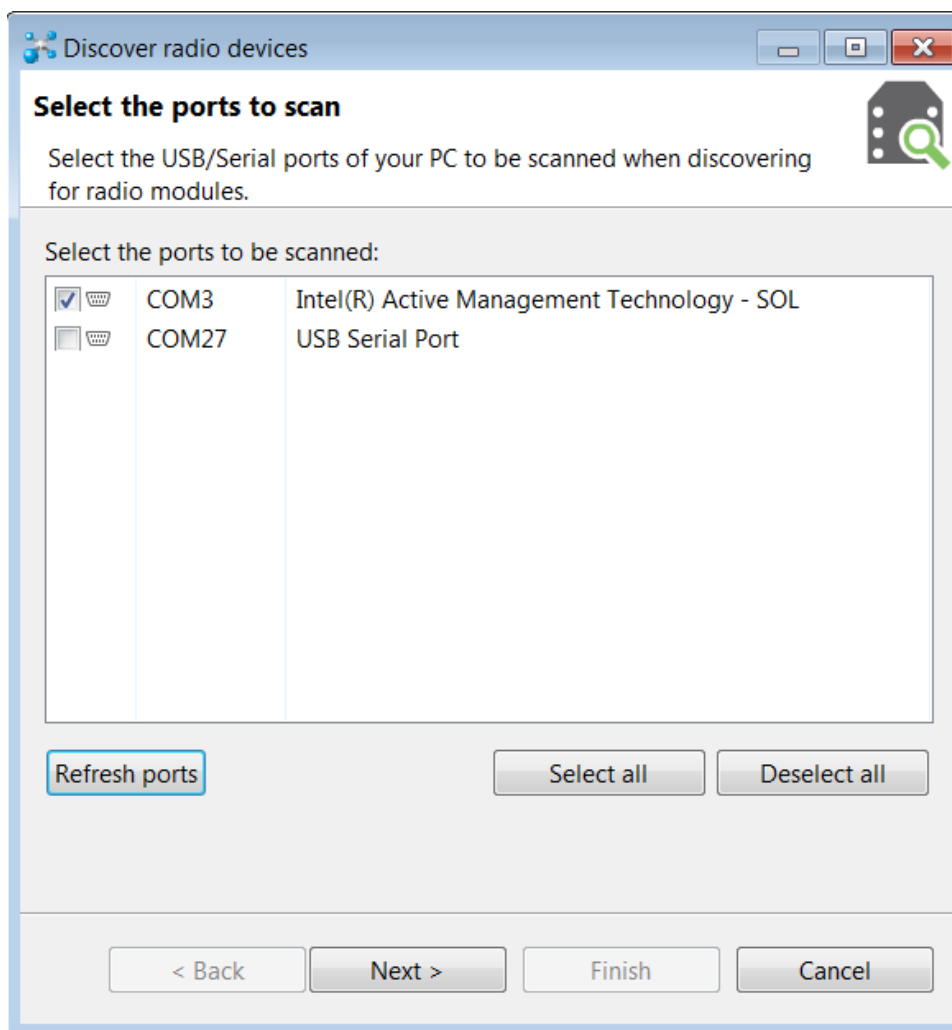

4. Remove the development board from the USB port and view which port name no longer appears in the **Discover radio devices** list of ports. The port name that no longer appears is the correct port for the development board.

Other reasons that the XBee Cellular Modem is not discoverable include:

1. If you accidentally have the loopback pins jumpered.
2. You may not be using an updated FTDI driver.
  - a. This may require you to reboot your computer.
  - b. Disconnect the power and USB from the XBIB-U-DEV board and reconnect it.

## Correct a macOS Java error

When you use XCTU on macOS computer, you may encounter a Java error.

### Condition

When opening XCTU for the first time on a macOS computer, you may see the following error:

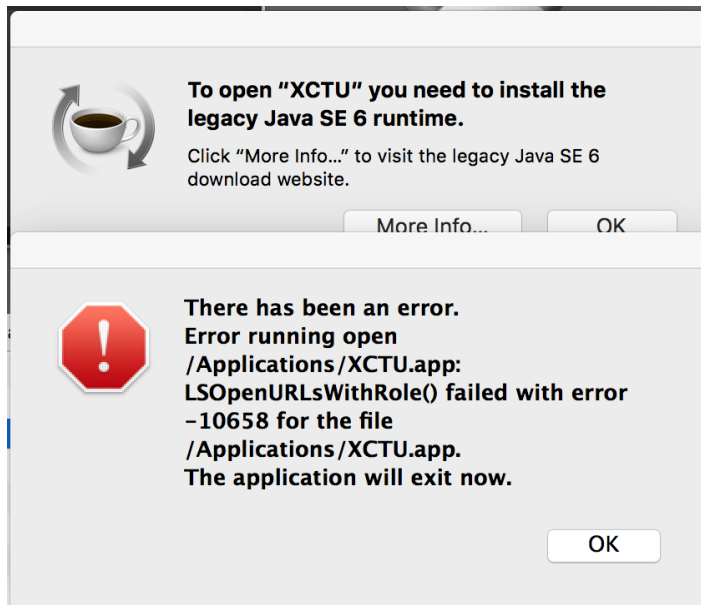

### Solution

1. Click **More info** to open a browser window.
2. Click **Download** to get the file javaforosx.dmg.
3. Double-click on the downloaded javaforosx.dmg.
4. In the dialog, double-click the JavaForOSX.pkg and follow the instructions to install Java.



## Unresponsive cellular component in Bypass mode

When in Bypass mode, the XBee Cellular Modem does not automatically reset or reboot the cellular component if it becomes unresponsive.

### Condition

In Bypass mode, the XBee Cellular Modem does not respond to commands.

### Solution

1. Query the [AI \(Association Indication\)](#) parameter to determine whether the cellular component is connected to the XBee Cellular Modem software. If **AI** is **0x2F**, Bypass mode should work. If not, look at the status codes in [AI \(Association Indication\)](#) for guidance.
2. You can send the [!R \(Modem Reset\)](#) command to reset only the cellular component.

## Not on expected network after APN change

### Condition

The XBee Cellular Modem is not on the expected network after a change to the [AN \(APN\)](#) command.

### Solution

Send **ATNR0** to reset Internet connectivity. See [NR \(Network Reset\)](#) for more information.

## Syntax error at line 1

You may get a **syntax error at line 1** error after pasting example MicroPython code and pressing **Ctrl+D**.

### Solution

This commonly happens when you accidentally type a character at the beginning of line 1 before pasting the code.

## Error Failed to send SMS

In MicroPython, you consistently get **Error Failed to send SMS** messages.

### Solution

Your device cannot connect to the cell network. The reason may be:

1. The antenna is improperly or loosely connected.
2. The device is at a location where cellular service cannot reach. If the device is connected to the network, the red LED blinks about twice in a second. If it is not connected it does not blink; see [The Associate LED](#).
3. Your SIM card is out of SMS text quota.
4. The device is not getting enough current, for example if power is being supplied only by USB to the XBIB development board, rather than using an additional external power supply.

## Certifications

---

Modification statement .....	132
Interference statement .....	132
Antenna specifications .....	132
FCC Class B digital device notice .....	133
Labelling requirements for the host device .....	133

## Modification statement

Digi International has not approved any changes or modifications to this device by the user. Any changes or modifications could void the user's authority to operate the equipment.

*Digi International n'approuve aucune modification apportée à l'appareil par l'utilisateur, quelle qu'en soit la nature. Tout changement ou modification peuvent annuler le droit d'utilisation de l'appareil par l'utilisateur.*

## Interference statement

This device complies with Part 15 of the FCC Rules and Industry Canada license-exempt RSS standard (s). Operation is subject to the following two conditions: (1) this device may not cause interference, and (2) this device must accept any interference, including interference that may cause undesired operation of the device.

*Le présent appareil est conforme aux CNR d'Industrie Canada applicables aux appareils radio exempts de licence. L'exploitation est autorisée aux deux conditions suivantes : (1) l'appareil ne doit pas produire de brouillage, et (2) l'utilisateur de l'appareil doit accepter tout brouillage radioélectrique subi, même si le brouillage est susceptible d'en compromettre le fonctionnement.*

## Antenna specifications

This equipment complies with FCC and IC radiation exposure limits set forth for an uncontrolled environment. The antenna should be installed and operated with minimum distance of 20 cm between the radiator and your body. Antenna gain must be below:

Frequency band	Gain
Band 4 (1700 MHz)	12.9 dBi
Band 13 (700 MHz)	6.0 dBi

This transmitter must not be co-located or operating in conjunction with any other antenna or transmitter.

*Cet appareil est conforme aux limites d'exposition aux rayonnements de la IC pour un environnement non contrôlé. L'antenne doit être installé de façon à garder une distance minimale de 20 centimètres entre la source de rayonnements et votre corps. Gain de l'antenne doit être ci-dessous:*

Bande de fréquence	Gain
Band 4 (1700 MHz)	12.9 dBi
Band 13 (700 MHz)	6.0 dBi

Band 4 (1700 MHz) 12.9 dBi

Band 13 (700 MHz) 6.0 dBi

*L'émetteur ne doit pas être colocalisé ni fonctionner conjointement avec à autre antenne ou autre émetteur.*

## FCC Class B digital device notice

This equipment has been tested and found to comply with the limits for a Class B digital device, pursuant to part 15 of the FCC Rules. These limits are designed to provide reasonable protection against harmful interference in a residential installation. This equipment generates, uses and can radiate radio frequency energy and, if not installed and used in accordance with the instructions, may cause harmful interference to radio communications. However, there is no guarantee that interference will not occur in a particular installation. If this equipment does cause harmful interference to radio or television reception, which can be determined by turning the equipment off and on, the user is encouraged to try to correct the interference by one or more of the following measures:

- Reorient or relocate the receiving antenna.
- Increase the separation between the equipment and receiver.
- Connect the equipment into an outlet on a circuit different from that to which the receiver is connected.
- Consult the dealer or an experienced radio/TV technician for help.

## Labelling requirements for the host device

The device shall be properly labelled to identify the product within the host device. The certification label of the module shall be clearly visible at all times when installed in the host device, otherwise the host device must be labelled to display the FCC ID and IC of the module, preceded by the words "Contains transmitter module", or the word "Contains", or similar wording expressing the same meaning, as follows:

Contains FCC ID: R17LE866SV1

Contains IC: 5131A-LE866SV1

*L'appareil hôte doit être étiqueté comme il faut pour permettre l'identification des modules qui s'y trouvent. L'étiquette de certification du module donné doit être posée sur l'appareil hôte à un endroit bien en vue en tout temps. En l'absence d'étiquette, l'appareil hôte doit porter une étiquette donnant le FCC ID et le IC du module, précédé des mots « Contient un module d'émission », du mot « Contient » ou d'une formulation similaire exprimant le même sens, comme suit :*

Contains FCC ID: R17LE866SV1

Contains IC: 5131A-LE866SV1

CAN ICES-3 (B) / NMB-3 (B)

This Class B digital apparatus complies with Canadian ICES-003.

*Cet appareil numérique de classe B est conforme à la norme canadienne ICES-003.*