



# AT Commands Examples

Examples for u-blox cellular modules

Application Note

## Abstract

This document provides detailed examples of how to use AT commands with u-blox cellular modules.

# Document Information

<b>Title</b>	<b>AT Commands Examples</b>	
<b>Subtitle</b>	Examples for u-blox cellular modules	
<b>Document type</b>	Application Note	
<b>Document number</b>	UBX-13001820	
<b>Revision and date</b>	R13	27-May-2019
<b>Disclosure Restriction</b>		

This document applies to the following products:

<b>Product name</b>
LEON-G1 series
SARA-G3 series
SARA-G4 series
LISA-U2 series
SARA-U2 series
TOBY-R2 series
LARA-R2 series
TOBY-L2 series
MPCI-L2 series

u-blox or third parties may hold intellectual property rights in the products, names, logos and designs included in this document. Copying, reproduction, modification or disclosure to third parties of this document or any part thereof is only permitted with the express written permission of u-blox.

The information contained herein is provided "as is" and u-blox assumes no liability for its use. No warranty, either express or implied, is given, including but not limited to, with respect to the accuracy, correctness, reliability and fitness for a particular purpose of the information. This document may be revised by u-blox at any time without notice. For the most recent documents, visit [www.u-blox.com](http://www.u-blox.com).

Copyright © u-blox AG.

# Contents

<b>Document Information</b> .....	<b>2</b>
<b>Contents</b> .....	<b>3</b>
<b>1 Introduction</b> .....	<b>8</b>
<b>2 AT command response parser</b> .....	<b>9</b>
2.1 Handle AT command response .....	9
2.2 Handle unsolicited result code .....	10
2.3 Best practices .....	11
<b>3 Parameters storing</b> .....	<b>12</b>
<b>4 Network registration and configuration</b> .....	<b>13</b>
4.1 Steps for registering the module with a cellular network.....	13
4.1.1 Preliminary operations.....	13
4.1.2 Network registration: GSM module .....	14
4.1.3 Network registration: UMTS module.....	15
4.1.4 Network registration: LTE module.....	19
4.1.5 Network operator configuration through +UMNOCNF AT command.....	21
4.1.6 PLMN list extension +UMNOPLMN: LTE module .....	23
4.1.7 Forbidden PLMN list management.....	23
4.1.8 Preferred PLMN list selection .....	24
4.2 Network registration flow-chart .....	26
4.2.1 Recommendations on registration failure handling.....	28
4.3 Simultaneous support of data and voice services .....	29
4.4 Configurations for optimized power consumption .....	29
<b>5 PS data connection</b> .....	<b>32</b>
5.1 External PDP context handling .....	32
5.1.1 External PDP context definition and activation .....	32
5.2 Secondary PDP context definition and activation in ROUTER mode.....	37
5.3 Internal PDP context activation .....	38
5.3.1 PDP contexts activation on Verizon Mobile Network Operator .....	39
5.4 Context deactivation .....	41
5.4.1 Context deactivation by the network .....	41
5.4.2 Context deactivation by the module.....	41
5.5 Using sockets on an already activated PDP context .....	41
5.5.1 PDP context activation by means of +UPSDA, impact of <PDP_type> on address.....	44
5.6 Management of counters of sent and received PSD data.....	45
5.7 DoCoMo PS PUSH context manual activation .....	46
5.8 DoCoMo PS PUSH context manual reject.....	47
5.9 Data connection management .....	47
5.9.1 Network policy: no IP connectivity on the default bearer .....	48
5.9.2 Network policy: only one bearer for each APN can be activated .....	49
5.9.3 Network policy: more than one bearer with the same APN can be activated .....	50
5.10 Network connectivity in ROUTER mode.....	52
5.10.1 2G/3G case .....	52

5.10.2	4G case.....	52
5.10.3	Set up the connection on Windows 7 .....	53
5.11	Network connectivity (BRIDGE mode) .....	56
5.11.1	2G/3G case .....	56
5.11.2	4G case.....	56
5.11.3	Set up the connection on Windows 7 .....	56
5.12	Dial-up .....	63
5.12.1	Generic dial-up.....	63
	AT+UUSBCONF? .....	63
5.12.2	Local dial-up.....	64
5.13	Data context active after boot .....	64
5.13.1	TOBY-L2 pseudo code .....	64
<b>6</b>	<b>IP Multimedia Subsystem (IMS) .....</b>	<b>65</b>
6.1	How to set IMS APN.....	65
6.2	How to disable/enable IMS client.....	65
6.3	IMS client registration .....	66
6.4	VoLTE call.....	66
<b>7</b>	<b>Speech calls.....</b>	<b>69</b>
7.1	Voice call monitoring .....	69
7.1.1	Quality of the radio link.....	69
7.1.2	Status of the calls.....	69
7.2	Conference calls .....	70
<b>8</b>	<b>Audio interface and parameters.....</b>	<b>72</b>
<b>9</b>	<b>Dynamic DNS AT command .....</b>	<b>74</b>
<b>10</b>	<b>TCP/IP AT commands .....</b>	<b>75</b>
10.1	Socket connect.....	75
10.2	Socket listening.....	75
10.3	Socket write .....	76
10.3.1	Binary mode .....	76
10.3.2	Base syntax.....	76
10.3.3	Queue FULL .....	77
10.3.4	GSM network coverage lost.....	77
10.4	Socket operations with "Keep Alive" option.....	79
10.5	Socket read .....	79
10.6	Socket state.....	81
10.7	Socket close .....	82
10.8	Direct link.....	82
10.8.1	Enter and exit from Direct link mode.....	82
10.8.2	Closing a connection .....	83
10.8.3	Connection closed by remote host.....	83
10.9	Socket Always On .....	84
10.9.1	Client configuration.....	84
10.9.2	Client operation.....	84
10.9.3	Server configuration .....	84



10.9.4	Server operation.....	85
10.10	IP Change notification.....	85
10.11	Verizon socket configuration.....	86
10.12	AT&T socket configuration.....	87
<b>11</b>	<b>UDP/IP AT commands .....</b>	<b>88</b>
11.1	Socket write (+USOST).....	88
11.2	Socket read (+USORF).....	88
11.3	Socket write (+USOWR).....	89
11.4	Socket read (+USORD).....	90
<b>12</b>	<b>FTP AT commands .....</b>	<b>91</b>
12.1	Direct link.....	92
12.1.1	Retrieve a file from FTP server.....	92
12.1.2	Aborting retrieve file request.....	93
12.1.3	Store a file on FTP server.....	93
12.1.4	About "+++" escape sequence usage.....	94
12.2	Using secure option.....	95
<b>13</b>	<b>SMTP AT commands .....</b>	<b>96</b>
<b>14</b>	<b>ODIS implementation .....</b>	<b>97</b>
14.1	OMA-DM client initialization.....	97
14.2	ODIS nodes.....	98
14.3	Module FW update notification.....	99
14.4	OMA-DM client activity reporting.....	100
<b>15</b>	<b>HTTP AT commands .....</b>	<b>101</b>
15.1	Using secure option.....	102
15.1.1	Importing a X.509 certificate.....	102
15.1.2	Examples about certificate validation levels.....	106
15.1.3	Data security and integrity.....	109
15.2	HTTP POST.....	110
15.3	HTTP cookies.....	111
<b>16</b>	<b>Network jamming detection AT commands.....</b>	<b>112</b>
16.1	Jamming detection threshold and number of carriers evaluation.....	112
16.1.1	Example 1: 2G threshold and number of carriers evaluation.....	113
16.2	Jamming detection in 2G network.....	113
16.2.1	Example 1: all the available 2G carriers jammed.....	113
16.3	Jamming detection in 3G network.....	114
16.3.1	Example 1: all the available 3G carriers jammed.....	114
16.4	Jamming detection in 2G/3G network.....	114
16.4.1	Example 1: all the available 2G and 3G carriers jammed.....	114
16.5	Advanced jamming detection in 2G network.....	115
16.5.1	Case 1: all the available 2G carriers jammed.....	115
16.5.2	Case 2: all the available 2G carriers jammed; selected PLMN not retrieved from IMSI.....	115
16.5.3	Case 3: not jammed 2G carrier(s) are not part of the selected PLMN.....	116
<b>17</b>	<b>Cell lock AT commands.....</b>	<b>117</b>
17.1	Cell lock in single mode.....	117

17.1.1	Cell lock in 2G network: normal mode .....	117
17.1.2	Cell lock in 2G network: extended mode.....	117
17.1.3	Cell lock in 2G network: normal mode .....	118
17.1.4	Cell lock in 2G network: extended mode.....	118
17.1.5	Cell lock in 3G network: normal mode.....	118
17.1.6	Cell lock in 3G network: extended mode.....	119
17.1.7	Cell lock in 3G network: extended + redirection mode .....	119
17.1.8	Cell lock in 4G network: normal mode.....	119
17.1.9	Cell lock in 4G network: extended mode.....	120
17.1.10	Cell lock in 4G network: extended + redirection mode .....	120
17.2	Cell lock in multi-mode .....	121
17.2.1	Cell lock in dual-mode: normal mode .....	121
17.2.2	Cell lock in dual-mode: extended mode.....	121
17.2.3	Cell lock in dual-mode: extended + redirection mode .....	121
17.2.4	Cell lock in tri-mode: normal mode.....	122
17.2.5	Cell lock in tri-mode: extended mode.....	122
17.2.6	Cell lock in tri-mode: extended + redirection mode.....	123
<b>18</b>	<b>ADC AT commands .....</b>	<b>124</b>
<b>19</b>	<b>GPIO AT commands .....</b>	<b>125</b>
<b>20</b>	<b>Multiplexer AT commands.....</b>	<b>127</b>
<b>21</b>	<b>File system AT commands .....</b>	<b>128</b>
<b>22</b>	<b>SIM toolkit.....</b>	<b>129</b>
22.1	Profile download .....	129
22.2	Proactive SIM .....	130
22.3	Example.....	131
22.3.1	Enable the SAT and terminal response .....	131
22.3.2	Changing the terminal profile .....	131
22.3.3	Entering SAT menu and selecting an item.....	132
22.3.4	Call setup.....	132
22.3.5	SIM Refresh proactive command handling .....	134
22.3.6	UICC reset .....	135
22.3.7	Envelope: idle screen available .....	135
22.3.8	IMSI swap .....	136
<b>23</b>	<b>SMS AT commands.....</b>	<b>138</b>
23.1	Read all messages or one single message.....	138
23.2	Read Messages on-the-fly .....	138
23.3	Delete one single message or multiple messages .....	139
23.4	Write and/or send one single message .....	139
23.5	Read all messages or one single message (concatenated SMS related commands) .....	140
23.6	Write and/or send a concatenated SMS message .....	141
23.7	Message Acknowledgement .....	142
<b>24</b>	<b>SIM lock AT command .....</b>	<b>144</b>
24.1	SIM lock activation and deactivation .....	144
24.2	SIM lock enabling and activation .....	144









<b>25 SIM Access Profile (SAP) AT commands .....</b>	<b>145</b>
25.1 SAP activation .....	145
25.2 SAP deactivation.....	146
<b>26 USB profile configuration.....</b>	<b>147</b>
26.1 High throughput profile .....	147
26.2 Fairly back-compatible profile.....	147
26.3 Low/Medium throughput profile.....	148
<b>Appendix .....</b>	<b>149</b>
<b>A Glossary .....</b>	<b>149</b>
<b>Related documents .....</b>	<b>151</b>
<b>Revision history .....</b>	<b>152</b>
<b>Contact.....</b>	<b>153</b>

# 1 Introduction



This document provides examples of using AT commands. See u-blox AT Commands Manual [1] for the AT command descriptions. The following symbols are used to highlight important information within the document:

-  An index finger points out key information pertaining to integration and performance.
-  A warning symbol indicates actions that could negatively impact or damage the module.

These icons will be used to indicate applicability to the related products:

-  : LEON-G1 series
-  : LISA-U2 series
-  : SARA-G3 series
-  : SARA-G4 series
-  : SARA-U2 series
-  : TOBY-L2 series
-  : TOBY-R2 series
-  : LARA-R2 series

If the subsection applies to a specific product, the related icon will be provided there.

-  The MPC1-L2 series provides the same feature set as the TOBY-L2 series. Therefore the "TOBY-L2" icon also refers to MPC1-L2 series.
-  The correctness of the networking examples depends on the availability of the website and FTP site. Be sure to use a valid website (or FTP site).



## 2 AT command response parser

LEON-G1

LISA-U2

SARA-G3

SARA-G4

SARA-U2

TOBY-L2

TOBY-R2

LARA-R2

The scope of this section is to give some hints about how to develop a proper AT parser and how to handle the AT command replies and the URCs.







In this document the following naming conventions are used:

- DCE (Data Communications Equipment) or MT (Mobile Terminal) is the u-blox cellular module
- DTE (Data Terminal Equipment) or TE (Terminal Equipment) is the terminal that sends the command to the module

### 2.1 Handle AT command response

When a generic AT command is issued, depending on the command sent, there may or may not be an information text response. At the end there is always the final result code, which marks the end of the command.

The following shows responses that can occur from DTE point of view:

- Wait for the command response
  - Actions to be taken when a timeout expires
- Response to the command
  - OK
  - +<cmd>: ...
  - OK
- Response to particular commands. For further details see "Information text responses and result codes" section in the u-blox AT Commands Manual [\[1\]](#)
  - CONNECT
  - NO CARRIER
  - BUSY
  - NO ANSWER
  - >
  - @
- Errors
  - +CME ERROR: ...
  - +CMS ERROR: ...
  - ERROR
- Command aborted
  -     ABORTED
  -   OK

 SARA-G4 and TOBY-L2 / MPC1-L2 series modules do not support the aborting of any AT commands.

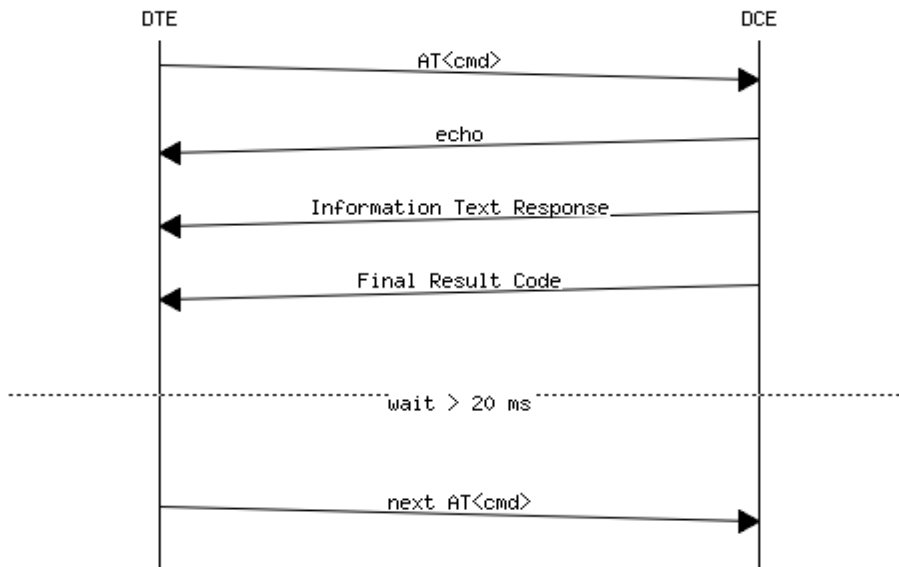

Figure 1: DTE-DCE AT command response flow chart

## 2.2 Handle unsolicited result code

An unsolicited result code (URC) is a string message (provided by the DCE) that is not a response to a previous AT command. It can be output, when enabled, at any time to inform the DTE of a specific event or status change. The URC can have the same name as the command that enables it (e.g. +CREG) or can be enabled by another command (e.g. unsolicited result code: +CMTI, command that enables it: +CNMI).

Examples of URCs:

- +<cmd>:...
- RING
- ...

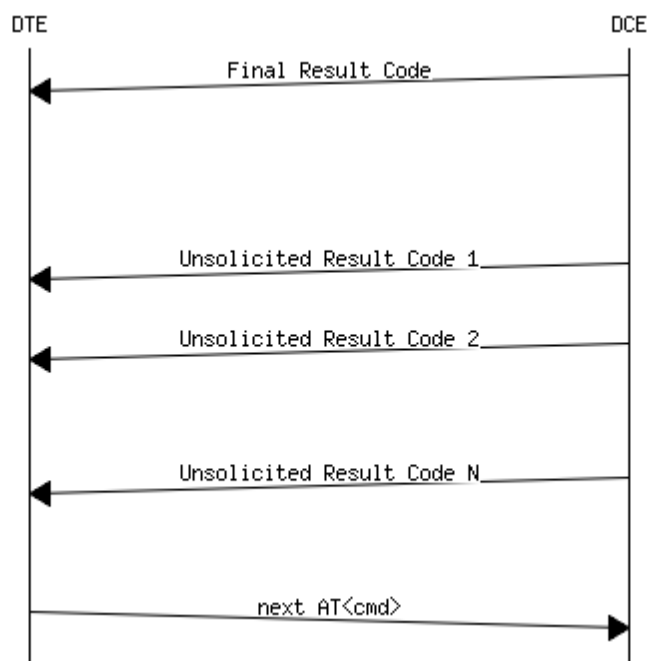

Figure 2: DTE-DCE URC flow chart

## 2.3 Best practices

- The DTE shall flush the AT channel (i.e. check if there are data waiting to be read) before sending a new AT command
- The DTE shall detect/process complete lines (see the S3, S4 and V0/V1 settings), so they can be processed with a function that handles responses
- The DTE shall handle the case of unexpected spaces or line endings
- The DTE shall handle all the URCs: it can simply ignore them (not suggested) or, better, take a proper action
- The DTE shall know what answer is expected and shall wait until it is received (i.e. final result code only or information text response + final result code)
- The final result code marks the end of an AT command and can be OK, ERROR or ABORTED: when the final result is an error, be sure to handle it before continuing with the next AT command
- The information text response format is command specific. The DTE will need explicit handling for each one. It is suggested to consult the u-blox AT Commands Manual [\[1\]](#)
- It is suggested not to strictly parse information text responses but to check if they contain interesting keywords and/or parameters
- The DTE shall know if the issued AT command can be aborted or not
- Some AT commands could output the final result code after some seconds, in this case check on AT manual for the suggested estimated response time. If the timeout expires then a decision should be taken accordingly: e.g. if the command can be aborted then try to abort it, etc ...
- It is very useful, for debugging an application, to log all the command lines sent to the DCE and what is received from it
- Create a state machine for the AT parser (i.e. idle, waiting\_response, data\_mode)
- The DTE shall wait some time (the recommended value is at least 20 ms) after the reception of an AT command final response or URC before issuing a new AT command to give the module the opportunity to transmit the buffered URCs. Otherwise the collision of the URCs with the subsequent AT command is still possible
- The DTE shall be aware that, when using a serial port without HW flow control, the first character is used to wake up the module from power saving

### 3 Parameters storing

LEON-G1

LISA-U2

SARA-G3

SARA-G4

SARA-U2

TOBY-L2

TOBY-R2

LARA-R2

The value of some AT command parameters can be saved and retrieved either in the user profiles or in the Non Volatile Memory (NVM) of the cellular module. For further details see the AT+CPWROFF, AT&V, AT&W, AT&Y command descriptions in the u-blox AT Commands Manual [1].

Command	Response	Description
AT+CMEE=2	OK	Set the verbose error result codes.
AT+UPSV=1	OK	Enable the power saving.  This is an example: the power saving is not by default enabled in the default profile.
AT&Y1	OK	Select the default profile that will be automatically loaded at the next hardware reset (in this example profile #1).
AT&W1	OK	Store the current settings into profile 1.
AT&V	ACTIVE PROFILE: &C1, &D1, &S1, &K3, E1, Q0, V1, X4,S00:000, S02:043, S03:013, S04:010,S05:008, S07:060, +CBST:007, 000,001, +CRLP:061, 061, 048, 006, +CR:000, +CRC:000, +IPR:0,+COPS:0,0,FFFFFF, +ICF:3,1, +UPSV: 1,2000, +CMGF:0, +CNMI:1,0,0,0,0, +USTS: 0 STORED PROFILE 0: &C1, &D1, &S1, &K3, E1, Q0, V1, X4,S00:000, S02:043, S03:013, S04:010, S05:008, S07:060, +CBST:007, 000, 001, +CRLP:061, 061, 048, 006, +CR:000, +CRC:000, +IPR:0, +COPS:0,0,FFFFFF, +ICF:3,1, +UPSV: 0, +CMGF:0, +CNMI:1,0,0,0,0, +USTS: 0 STORED PROFILE 1: &C1, &D1, &S1, &K3, E1, Q0, V1, X4, S00:000, S02:043, S03:013, S04:010, S05:008, S07:060, +CBST:007, 000, 001, +CRLP:061, 061, 048, 006, +CR:000, +CRC:000, +IPR:0, +COPS:0,0,FFFFFF, +ICF:3,1, +UPSV: 1,2000, +CMGF:0, +CNMI:1,0,0,0,0, +USTS: 0 OK	Display both the current profile and the user profiles stored in memory.  This step is not mandatory.  This example refers to LEON-G1 series modules, different values are shown on the other u-blox modules.
AT+CSGT=1,"u-blox module"	OK	Set a new greeting text ("u-blox module" in this example). This is not the factory-programmed value stored in the NVM.
AT+CFUN=15	OK	Save the stored configuration and reboot the module without needing to switch the module off and back on.  The current configuration can be stored switching the module off through AT+CPWROFF command.
	u-blox module	At module power-on the greeting text is displayed.
AT+UPSV?	+UPSV: 1,2000 OK	Read the current configuration of +USPV AT command.

## 4 Network registration and configuration

LEON-G1
LISA-U2
SARA-G3
SARA-G4
SARA-U2
TOBY-L2
TOBY-R2
LARA-R2

### 4.1 Steps for registering the module with a cellular network

Perform the module registration with the network as follows:

- Set the PIN
- Perform the network registration

#### 4.1.1 Preliminary operations

Command	Response	Description
AT+CMEE=2	OK	Set the verbose error result codes. This step is not mandatory.
AT+CPIN?	+CPIN: SIM PIN OK	Check the PIN.
AT+CPIN="1234"	OK	Set the PIN ("1234" is an example).
AT+CPIN?	+CPIN: READY OK	Check the PIN. OK, the PIN is ready.

If a wrong PIN is inserted for three times, the SIM will be locked and the cellular module will require the PUK to be inserted to unlock the SIM.

Command	Response	Description
AT+CPIN="123456890", "1234"	OK	Insert the PUK 123456890 and enable the new PIN 1234.

Sometimes, the PIN2 is required to unlock the access to a small set of features (e.g., calls to certain numbers or specific actions to the SIM card). In case the wrong PIN2 is inserted for more than 3 times, the PUK2 will be required, as in the following example.

Command	Response	Description
AT+CMEE=2	OK	Set the verbose error result codes. This step is not mandatory.
AT+CLCK="FD", 0, "7703"	+CME ERROR: SIM PUK2 required	The operation is not allowed, PUK2 is required given that PIN2 has been entered wrong for more than 3 times.
ATD**052*2222222*9999*9999#	OK	Insert the PUK2 "2222222" and the new PIN2 "9999".
AT+CPIN?	+CPIN: SIM PIN OK	Check the PIN.
AT+CLCK="FD", 0, "9999"	OK	Operation now allowed (unlock of the SIM fixed dialing phonebook) with the correct PIN2.
AT+CPIN?	+CPIN: READY OK	Check the PIN. OK, the PIN is ready.

## 4.1.2 Network registration: GSM module

LEON-G1

SARA-G3

SARA-G4

### 4.1.2.1 Check network registration (first scenario, auto-registration)

Command	Response	Description
AT+COPS?	+COPS: 0,0,"vodafone IT" OK	Check the network registration status. If the first parameter is 0 then the module is registered with GSM network.
AT+CGATT?	+CGATT: 1 OK	Check the GPRS attach status. The first parameter indicates the GPRS status (in this case 1 - GPRS attached).

### 4.1.2.2 Check network registration (second scenario, without auto-registration)

Command	Response	Description
AT+COPS?	+COPS: 2 OK	Check the network registration status. If the parameter is 2 then the module is not registered with GSM network.
AT+COPS=0	OK	Start the automatic network registration.
AT+COPS?	+COPS: 0,0,"vodafone IT" OK	Check the network registration status. If the first parameter is 0 then the module is registered with GSM network.

### 4.1.2.3 Check network registration (third scenario, data only SIMs)

Command	Response	Description
AT+COPS?	+COPS: 0 OK	Check the network registration status. When using data only SIMs, in some networks at the +COPS read command returns the operator name, in other networks returns only 0, even if the GPRS network registration is enabled.
AT+CREG?	+CREG: 0,3 OK	Check network registration status.
AT+CGREG?	+CGREG: 0,1 OK	Check GPRS network registration status.
AT+UCGOPS?	+UCGOPS: 0,0,"00101",2 OK	Check PS (Packet Switched) network registration status.

It is not advised to issue AT+COPS=0 immediately after forcing the de-registration with AT+COPS=2, because the PS detach might still be pending. Instead, the +CGEREP AT command enables the URC through which it is possible to have asynchronous notifications about GPRS events and, thus, NW DETACH events. If a NW DETACH event occurs and the DTE would like to trigger a new NW registration, it can use the AT+CGATT=1 command after a guard timer, during which the device is expected to perform a re-attach automatically. For DTEs that do not want to leverage URC, the +CEER and +CGATT AT commands are suggested.

### 4.1.2.4 GSM band change

Command	Response	Description
AT+UBANDSEL?	+UBANDSEL: 900, 1800 OK	Check the current selected GSM bands.
AT+COPS=2	OK	De-register the module from the network. Perform this operation only if the module is registered with the network.
AT+UBANDSEL=850,1900	OK	Change the operating GSM bands. The new configuration is saved in NVM for future registration attempts.
AT+COPS=0	OK	Start the automatic network registration.

## 4.1.3 Network registration: UMTS module

LISA-U2
SARA-U2

### 4.1.3.1 Preliminary information on Radio Access Technology (RAT) configuration

The default RAT configuration is GSM / UMTS dual-mode, with UMTS the preferred access technology.

Command	Response	Description
AT+URAT?	+URAT: 1, 2 OK	The default RAT configuration is GSM / UMTS dual-mode Radio Access Technology with UMTS preferred access technology. The module can access both GSM and UMTS networks, where UMTS is the preferred RAT.

Deregister the module from the network with **AT+COPS=2** command before changing the RAT configuration.

Power off the module (**AT+CPWROFF**) to save the RAT configuration in the NVM. After this, switch on the module and repeat the steps listed in section 4.1.1.

When a new RAT setting is saved in the NVM it is not possible to load the RAT factory-programmed configuration. To restore this perform the following steps:

Command	Response	Description
AT+COPS=2	OK	Deregister the module from the network. Perform this operation only if the module is registered with the network.
AT+URAT=1, 2	OK	Select GSM / UMTS dual-mode Radio Access Technology with UMTS networks preferred. This is the RAT factory defined configuration.
AT+CPWROFF	OK	Switch off the module.

### 4.1.3.2 RAT selection

#### GSM single mode RAT

Command	Response	Description
AT+URAT=0, 0	OK	Select GSM Single Mode Radio Access Technology.
AT+URAT?	+URAT: 0, 0 OK	The module can access only GSM networks.
AT+COPS=0	OK	Start the automatic network registration.

Command	Response	Description
AT+COPS?	+COPS: 0,0,"vodafone IT",0 OK	Check the network registration status. The last parameter describes which type of RAT (2G or 3G) the module is currently registered to (0 - GSM in this case).

### GSM / UMTS dual-mode RAT

Command	Response	Description
AT+URAT=1,0	OK	Select GSM / UMTS dual-mode Radio Access Technology, GSM is the preferred access technology.
AT+URAT?	+URAT: 1,0 OK	With this configuration the module can access both GSM and UMTS networks, GSM is the preferred RAT.
AT+URAT=1,2	OK	Select GSM / UMTS dual-mode Radio Access Technology, UMTS is the preferred RAT.
AT+URAT?	+URAT: 1,2 OK	With this configuration the module can access both GSM and UMTS networks, UMTS is the preferred RAT.
AT+COPS=0	OK	Start the automatic network registration.
AT+COPS?	+COPS: 0,0,"vodafone IT",2 OK	Check the network registration status. The last parameter describes which type of RAT (2G or 3G) the module is currently registered to (2 - UMTS in this case).
AT+COPS?	+COPS: 0,0,"vodafone IT",0 OK	The module is also allowed to access GSM networks. This will be the information text response if it is registered with GSM service.

### UMTS single mode RAT

Command	Response	Description
AT+URAT=2,2	OK	Select UMTS Single Mode Radio Access Technology.
AT+URAT?	+URAT: 2,2 OK	With this configuration the module can access only UMTS networks.
AT+COPS=0	OK	Start the automatic network registration.
AT+COPS?	+COPS: 0,0,"vodafone IT",2 OK	Check the network registration status. The last parameter describes which type of RAT (2G or 3G) the module is currently registered to (2 - UMTS in this case).

 If the module is registered with GSM / UMTS dual-mode (**AT+URAT=1,0** or **AT+URAT=1,2**) it is possible to change the preferred RAT technology but the new setting only takes effect after a period of lost network coverage or if the module is deregistered and re-registered on the network.



Command	Response	Description
AT+URAT=1,0	OK	Select the GSM / UMTS dual-mode Radio Access Technology. GSM is the preferred access technology.
AT+URAT?	+URAT: 1,0 OK	With this configuration the module can access both GSM and UMTS networks, GSM networks are preferred.
AT+COPS=0	OK	Start the automatic network registration.



Command	Response	Description
AT+COPS?	+COPS: 0,0,"vodafone IT",0 OK	Check the network registration status. The last parameter describes which type of RAT (2G or 3G) the module is currently registered to (0 - GSM in this case).
AT+URAT=1,2	OK	Select the GSM / UMTS dual-mode Radio Access Technology. UMTS is the preferred access technology.
AT+URAT?	+URAT: 1,2 OK	With this configuration the module can access both GSM and UMTS networks, UMTS networks are preferred.
AT+COPS?	+COPS: 0,0,"vodafone IT",0 OK	The last parameter describes which type of RAT (2G or 3G) the module is currently registered to (0 - GSM in this case although UMTS is now the preferred access technology).
AT+COPS=2	OK	Deregister the module from the network.
AT+COPS=0	OK	Start the automatic network registration.
AT+COPS?	+COPS: 0,0,"vodafone IT",2 OK	The last parameter describes which type of RAT (2G or 3G) the module is currently registered to (2 - UMTS in this case).   This is only an example. Remember that with +URAT=1,2 UMTS is the preferred and not the only allowed RAT. If the UMTS network coverage is weak the module will register again on GSM network.

 **AT+URAT=0,2** and **AT+URAT=2,0** are allowed but the second parameter is ignored. The second parameter applies only to GSM / UMTS dual-mode Radio Access technology (first parameter equal to 1). In the read command and with this setting, the second parameter of the information text response can be omitted.

### 4.1.3.3 UMTS band change

Command	Response	Description
AT+URAT?	+URAT: 1,2 OK	Check if the module is configured in dual-mode or 3G only.  Alternative answers may be +URAT: 2,0 or URAT: 1,0.
AT+COPS?	+COPS: 0,0,"vodafone IT",2 OK	If the module is registered, check that it is in UMTS RAT.
AT+UBANDSEL?	+UBANDSEL: 2100,1900,850 OK	Check the current 3G bands.
AT+COPS=2	OK	Start the automatic network registration.
AT+UBANDSEL=800,900	OK	Change the operating 3G bands.  The new configuration is saved in NVM for future registration attempts.
AT+COPS=0	OK	Force the network registration.

### 4.1.3.4 Check the device PS radio capabilities

The table below lists the allowed combinations of +URAT, +COPS and +UREG AT commands.



RAT configuration	Operator	Network registration status
+URAT: 0,0	+COPS: 0,0,"vodafone IT",0	+UREG: 0,0
+URAT: 0,0	+COPS: 0,0,"vodafone IT",0	+UREG: 0,1
+URAT: 0,0	+COPS: 0,0,"vodafone IT",0	+UREG: 0,2
+URAT: 1,0	+COPS: 0,0,"vodafone IT",0	+UREG: 0,0
+URAT: 1,0	+COPS: 0,0,"vodafone IT",0	+UREG: 0,1
+URAT: 1,0	+COPS: 0,0,"vodafone IT",0	+UREG: 0,2
+URAT: 1,0	+COPS: 0,0,"vodafone IT",2	+UREG: 0,3
+URAT: 1,0	+COPS: 0,0,"vodafone IT",2	+UREG: 0,4
+URAT: 1,0	+COPS: 0,0,"vodafone IT",2	+UREG: 0,5
+URAT: 1,0	+COPS: 0,0,"vodafone IT",2	+UREG: 0,6
+URAT: 1,2	+COPS: 0,0,"vodafone IT",2	+UREG: 0,0
+URAT: 1,2	+COPS: 0,0,"vodafone IT",0	+UREG: 0,1
+URAT: 1,2	+COPS: 0,0,"vodafone IT",0	+UREG: 0,2
+URAT: 1,2	+COPS: 0,0,"vodafone IT",2	+UREG: 0,3
+URAT: 1,2	+COPS: 0,0,"vodafone IT",2	+UREG: 0,4
+URAT: 2,2	+COPS: 0,0,"vodafone IT",2	+UREG: 0,0
+URAT: 2,2	+COPS: 0,0,"vodafone IT",2	+UREG: 0,3
+URAT: 2,2	+COPS: 0,0,"vodafone IT",2	+UREG: 0,4
+URAT: 2,2	+COPS: 0,0,"vodafone IT",2	+UREG: 0,5
+URAT: 2,2	+COPS: 0,0,"vodafone IT",2	+UREG: 0,6

## 4.1.4 Network registration: LTE module

TOBY-L2

### 4.1.4.1 Preliminary information on Radio Access Technology (RAT) configuration

Command	Response	Description
AT+URAT?	+URAT: 4, 3 OK	In this example the RAT configuration is GSM / UMTS / LTE tri-mode Radio Access technology with LTE as preferred access technology. The module can access both GSM, UMTS and LTE networks, where LTE is the preferred RAT.

-  Deregister the module from the network with the **AT+CFUN=4** command before changing the RAT configuration.
-  Issue this command sequence to ensure the preferred RAT is selected after the network de-registration / registration:
  - AT+CFUN=4
  - AT+URAT=<SelectedAcT>,<PreferredAcT>
  - AT+CFUN=1
-  Power off the module (**AT+CPWROFF**) to store the RAT configuration in the NVM. After this, switch on the module and repeat the steps listed in section 4.1.1.

When a new RAT setting is saved in the NVM it is not possible to load the RAT factory-programmed configuration. To restore this, perform the following steps:

Command	Response	Description
AT+CFUN=4	OK	Deregister the module from the network. Perform this operation only if the module is registered with the network.
AT+URAT=4, 3	OK	Select GSM / UMTS / LTE tri-mode RAT with LTE networks preferred. This is the RAT factory-programmed configuration.
AT+CPWROFF	OK	Switch off the module.

### 4.1.4.2 RAT selection

#### LTE single mode RAT

Command	Response	Description
AT+CFUN=4	OK	Set the module in airplane mode.
AT+URAT=3	OK	Select LTE Single Mode RAT.
AT+URAT?	+URAT: 3 OK	The module can access only LTE networks.
AT+CFUN=1	OK	Set the module in full functionality.
AT+COPS?	+COPS: 0, 0, "vodafone IT", 7 OK	Check the network registration status. The last parameter describes which type of RAT (2G, 3G or 4G) the module is currently registered to (7 – LTE in this case).

## UMTS / LTE dual-mode RAT

Command	Response	Description
AT+CFUN=4	OK	Set the module in airplane mode.
AT+URAT=6,2	OK	Select UMTS / LTE dual-mode Radio Access Technology, UMTS is the preferred access technology.
AT+URAT?	+URAT: 6,2 OK	With this configuration the module can access both UMTS and LTE networks, UMTS is the preferred RAT.
AT+URAT=6,3	OK	Select UMTS / LTE dual-mode Radio Access technology, LTE is the preferred RAT.
AT+URAT?	+URAT: 6,3 OK	With this configuration the module can access both UMTS and LTE networks, LTE is the preferred RAT.
AT+CFUN=1	OK	Set the module in full functionality.
AT+COPS?	+COPS: 0,0,"vodafone IT",2 OK	Check the network registration status. The last parameter describes which type of RAT (2G, 3G or 4G) the module is currently registered to (2 - UMTS in this case).
AT+COPS?	+COPS: 0,0,"vodafone IT",7 OK	The module is also allowed to access LTE networks. This will be the information text response if it is registered with LTE service.

### 4.1.4.3 LTE band change

Command	Response	Description
AT+URAT?	+URAT: 4,3 OK	Check module configuration (single, dual or tri-mode).
AT+COPS?	+COPS: 0,0,"vodafone IT",7 OK	If the module is registered, check that it is in LTE RAT.
AT+UBANDSEL?	+UBANDSEL: 800,850,900,1800,1900,2100,2600 OK	Check the current 3G bands.
AT+CFUN=4	OK	Set the module in airplane mode.
AT+UBANDSEL=1800,2100,2600	OK	Change the operating LTE bands.  The new configuration is saved in NVM for future registration attempts.
AT+CFUN=1	OK	Set the module in full functionality.

### 4.1.4.4 Check EPS current network registration status (CS)

Command	Response	Description
AT+CEREG?	+CEREG: 0,1 OK	Read the EPS network registration status: the URCS are disabled and the module is registered on home PLMN.
AT+CEREG=1	OK  +CEREG: 2	Enables the URCS for EPS network registration status. The module is not registered, but it is currently trying to attach or searching an operator to register to.
AT+CEREG=2	OK  +CEREG: 1,"5A25","0099EA20",7	Enables the URCS for EPS network registration status and location information. The module is registered on home PLMN, then follow the TAC, the cell id and the RAT.

Command	Response	Description
AT+CEREG=3	OK  +CEREG: 1, "5A25", "0099EA20", 7	Enables the URCs for EPS network registration status, location information and EMM cause value information.  The module is registered on home PLMN, then follow the TAC, the cell id and the RAT. EMM info are not available.

#### 4.1.4.5 Check EPS current network registration status (PS)



Command	Response	Description
AT+UREG=1	OK  +UREG: 1, 2 OK	Enable a network registration attach status URC.  The DUT generates a URC when the network attach status changes. The second parameter (2 in this example) indicates the new network registration status.  The first parameter indicates the URC status (in this case 1 - enabled) meaning URC is still enabled.

### 4.1.5 Network operator configuration through +UMNOCONF AT command

TOBY-L2

TOBY-R2

LARA-R2

-  This section does not apply to TOBY-L2 "00S" and "50S" product versions.
-  For <MNO> and <conf> values allowed by each product, see the u-blox AT Commands Manual [\[1\]](#).

This command switches between different configurations of the mobile network operators (MNO). The MNO configuration can be manual or automatic (based on the current USIM card inserted).

#### 4.1.5.1 Manual configuration

After a manual configuration request:

- the module will de-register and de-activate the radio
- the module performs all required configuration changes
- the DTE is required to manually reboot the module via AT command

#### Manual regulatory configuration

Command	Response	Description
AT+UMNOCONF=0	OK	The regulatory MNO configuration is set: IMS service is disabled, Verizon connection manager is disabled, all 4G and 3G bands are enabled. The <conf> parameter is ignored.
AT+CFUN=16	OK	Reboot the module to apply the new configuration.

### Manual AT&T configuration

Command	Response	Description
AT+UMNOCONF=2	OK	The AT&T configuration is set: IMS service is disabled, Verizon connection manager is disabled, 3G bands are enabled, all supported 4G bands are enabled, HSDPA category set to 14.
AT+CFUN=16	OK	Reboot the module to apply the new configuration.

### Manual Verizon configuration

Command	Response	Description
AT+UMNOCONF=3, 7	OK	The Verizon configuration is set with: <ul style="list-style-type: none"> <li>the internal connection manager active</li> <li>VZWINTERNET on demand</li> </ul>
AT+CFUN=16	OK	Reboot the module to apply the new configuration.

Command	Response	Description
AT+UMNOCONF=3, 15	OK	The Verizon configuration is set with: <ul style="list-style-type: none"> <li>the internal connection manager active</li> <li>IMS test mode active</li> </ul>
AT+CFUN=16	OK	Reboot the module to apply the new configuration.

Command	Response	Description
AT+UMNOCONF=3, 23	OK	The Verizon configuration is set with: <ul style="list-style-type: none"> <li>the internal connection manager active</li> <li>VZWINTERNET automatically handled</li> </ul>
AT+CFUN=16	OK	Module is rebooted to apply the new configuration.

### 4.1.5.2 Automatic configuration

After an automatic configuration request:

- the module will detect the correct configuration based on SIM IMSI
- if SIM is present but its IMSI is not AT&T nor Verizon then the regulatory configuration is applied
- if no SIM is present then the previous valid configuration is kept
- the FW will be able to handle SIM IMSI refresh (provisioning)
- if a configuration change is needed then the module will de-register and de-activate the radio, perform the required configuration changes and; issue a URC on AT terminal and optionally can perform a power cycle after the URC has been printed.

Command	Response	Description
AT+UMNOCONF?	+UMNOCONF: 2, 7 OK	TOBY-L201-01S is flashed with its FW and it is powered on without a SIM card inserted. As expected the factory configuration is AT&T (default value).
AT+UMNOCONF=1, 7	OK	The module is set in automatic mode configuration.
AT+UMNOCONF?	+UMNOCONF: 1, 7, 2	As expected, no URC is printed since no valid SIM has been detected: the current configuration is kept.

Command	Response	Description
AT+CFUN=19	OK	The protocol stack is turned off. After receiving the 'OK' final result code a Verizon SIM is inserted.
AT+CFUN=1	OK +UMNOCONF: 1,7,3	The protocol stack is turned on. A SIM has been previously inserted and the module recognizes the SIM's IMSI. The module is automatically reconfigured, print a URC (+UMNOCONF) and then perform a power cycle.
AT+UMNOCONF?	+UMNOCONF: 1,7,3 OK	On next reboot the MNO configuration is checked. Suppose now that for some reason the SIM becomes unreadable, in this case the module will maintain the current configuration until the SIM is replaced or until a new manual configuration is set.

#### 4.1.6 PLMN list extension +UMNOPLMN: LTE module

TOBY-L2

This section does not apply to "00S" and "50S" product versions.

This command customizes the list used by AT+UMNOCONF's automatic SIM detection algorithm. It configures the mapping of the current detected MNO to one of the pre-defined MNO values. It is possible to extend the PLMN list of these MNOs:

- AT&T
- Verizon

Command	Response	Description
AT+UMNOPLMN?	+UMNOPLMN: 2,"310.30,310.150,310.170,310.280,310.380,310.410,310.560" +UMNOPLMN: 3,"310.590,310.890,311.480" OK	The module is powered on. This is the factory-programmed configuration.
AT+UMNOPLMN=3,"310.150"	+CME ERROR: operation not allowed	"310.150" overlaps the current setting of <detectable_MNO>=2.
AT+UMNOPLMN=3,"1000.100"	+CME ERROR: operation not supported	"1000.100" is not a valid PLMN id.
AT+UMNOPLMN=2	OK	<detectable_MNO>=2 has been reset to its factory-programmed value.

#### 4.1.7 Forbidden PLMN list management

LISA-U2

SARA-U2

TOBY-L2

TOBY-R2

LARA-R2

The SIM contains an Elementary File (EF), namely Forbidden Public Land Mobile Network (FPLMN), listing the MNO with which registration operations are forbidden, given to errors that happened in the past. This file is read by the ME during the SIM initialization procedure and indicates PLMNs which the MS shall not automatically attempt to access.

A new PLMN is added to this EF if a network rejects a Location Update with the cause "PLMN not allowed".

Cases are possible in which a network normally used by a SIM is put in this list, due to specific agreements between MNOs or specific operational conditions.

The following commands provide guidelines about the recovery of the connectivity with the MNO:

Command	Response	Description
AT+COPS=1,2,"22288"	OK	Assuming that the operator id. 22288 was in FPLMN, the manual selection of this operator deletes it from the FPLMN.
AT+COPS=0	OK	Restore the Automatic Operator Selection mode.

Command	Response	Description
AT+CRSM=214, 28539, 0, 0, 12, "FFFFFFFFFFFFFFFFFFFFFFFF"	+CRSM: 144,0 OK	Reset the FPLMN EF to its default value.

In case the PLMN file is empty and the module is still in limited service condition, then the SIM is not valid anymore or it tried the attach procedure with an operator that rejected it with a terminal cause (e.g., SIM invalid). In this case, issue AT+CFUN=16 to silently reset the module and try again.

#### 4.1.8 Preferred PLMN list selection

LISA-U2
SARA-G3
SARA-U2
TOBY-L2
TOBY-R2
LARA-R2

The PLMNs that can be selected by a specific SIM can be controlled in three different ways, according to a particular EF stored in the SIM and selected through the setting of the +CPLS AT command, as reported in the following table.

+CPLS setting	Selector name	EF	DTE Permissions on EF
0	User-controlled	EF <sub>PLMNwAcT</sub> or EF <sub>PLMNsel</sub>	Read + Write
1	Operator-controlled	EF <sub>OPLMNwAcT</sub>	Read-only
2	HPLMN-controlled	EF <sub>HPLMNwAcT</sub>	Read-only

In case the +CPLS AT command is set to a value different than 0, the DTE cannot operate in any way to modify the PLMNs that can be selected. As a result, the +CPOL AT command returns an error result code.

PLMN selector not user-controlled		
Command	Response	Description
AT+CMEE=2	OK	Set verbose error result codes.
AT+CPLS?	+CPLS: 1 OK	Operator-controlled PLMN selector with access technology.
AT+CPOL?	+CME ERROR: not found	The AT command returns an error result code because the +CPLS AT command is set to a value that is not user-controlled.

If the +CPLS AT command is set to the value 0 (i.e., user-controlled) and the SIM card allows to use the service n.20 User controlled PLMN selector with Access Technology (for more details, see 3GPP TS 31.102 [16]), then it is possible to modify the user-controlled PLMN selector by removing and adding MNOs to the list.



Service not available in the SIM		
Command	Response	Description
AT+CMEE=2	OK	Set verbose error result codes.
AT+CPLS?	+CPLS: 0 OK	User-controlled PLMN selector with access technology.
AT+CRSM=176,28472,0,0,0	+CRSM: 144,0,"1EFA170C630602000220000" OK	Read the value of the EF 0x6F38 (28472 in decimal format). The service no. 20 is present if the 4 <sup>th</sup> bit in the 3 <sup>rd</sup> byte is set to 1. In this case the 3 <sup>rd</sup> byte is 0x17, that is 00010111 in binary notation, thus the service no.20 is not available.
AT+CPOL?	+CME ERROR: not found	The AT command returns an error result code because even if CPLS is set to a value that is user-controlled, the service is not available in the SIM.

Service available		
Command	Response	Description
AT+CMEE=2	OK	Set verbose error result codes.
AT+CPLS?	+CPLS: 0 OK	User-controlled PLMN selector with access technology.
AT+CRSM=176,28472,0,0,0	+CRSM: 144,0,"0EEE1F8C630E58000" OK	Read the value of the EF 0x6F38 (28472 in decimal format). The service no. 20 is present if the 4 <sup>th</sup> bit in the 3 <sup>rd</sup> byte is set to 1. In this case the 3 <sup>rd</sup> byte is 0x1F, that is 00011111 in binary notation, thus the service no.20 is available.
AT+CRSM=192,28512,0,0,0	+CRSM: 144,0,"62258202412183026F60A50C80017192010091047F206F608A01058B036F060E80020177880150" OK	Verify if the EF <sub>PLMNwAcT</sub> file is present. The first and the second parameter of the response are 0x90 and 0x00, respectively. Thus, the file is present.
AT+CPOL?	+CPOL: 1,2,"20810",1,0,1,0 +CPOL: 2,2,"21401",1,0,1,0 ... +CPOL: 50,2,"22210",1,0,1,0 OK	The AT command returns the content of the EF <sub>PLMNwAcT</sub> .
AT+COPN	+COPN: "90114","AeroMobile" ... +COPN: "22210","vodafone IT" OK	List the available MNOs, that is possible to set through the CPOL AT command.
AT+CPOL=50	OK	Reset the row no. 50 in the EF <sub>PLMNwAcT</sub> .
AT+CPOL=50,2,"22210",1,0,1,0	OK	Insert the operator with ID "22210" (i.e., Vodafone IT) in the row no. 50 in EF <sub>PLMNwAcT</sub> .

 On SARA-G3 series, the +CPOL command does not read EF<sub>PLMNsel</sub> if EF<sub>PLMNwAcT</sub> is not present. In this case the DTE can read the content of the file through the +CRSM AT command indicating the EF 0x6f30, issuing: AT+CRSM=176,28464,0,0,96.

## 4.2 Network registration flow-chart

LEON-G1   LISA-U2   SARA-G3   SARA-G4   SARA-U2   TOBY-L2   TOBY-R2   LARA-R2

It is strongly suggested to enable the following URCs (AT+C(x)REG=2 when possible) after the module power-on to know the module's registration status:

- **+CREG** provides information about the CS network registration status (2G/3G/4G);
- **+CGREG** provides information about the PS network registration status (2G/3G);
- **+CEREG** provides information about the EPS network registration status (4G).

Using a logic OR between these indicators it is possible to know the registration status.

Monitoring these URCs the DTE is always aware of the network status registration for the CS and PS subsystem. The actions to be taken by DTE are similar for +CREG, +CGREG and +CEREG, but the causes may be different.

Figure 3 shows the suggested operations and actions for a CS and PS registration from the DTE point of view. See the u-blox AT Commands Manual [1] for more detailed information about +CREG, +CGREG and +CEREG.

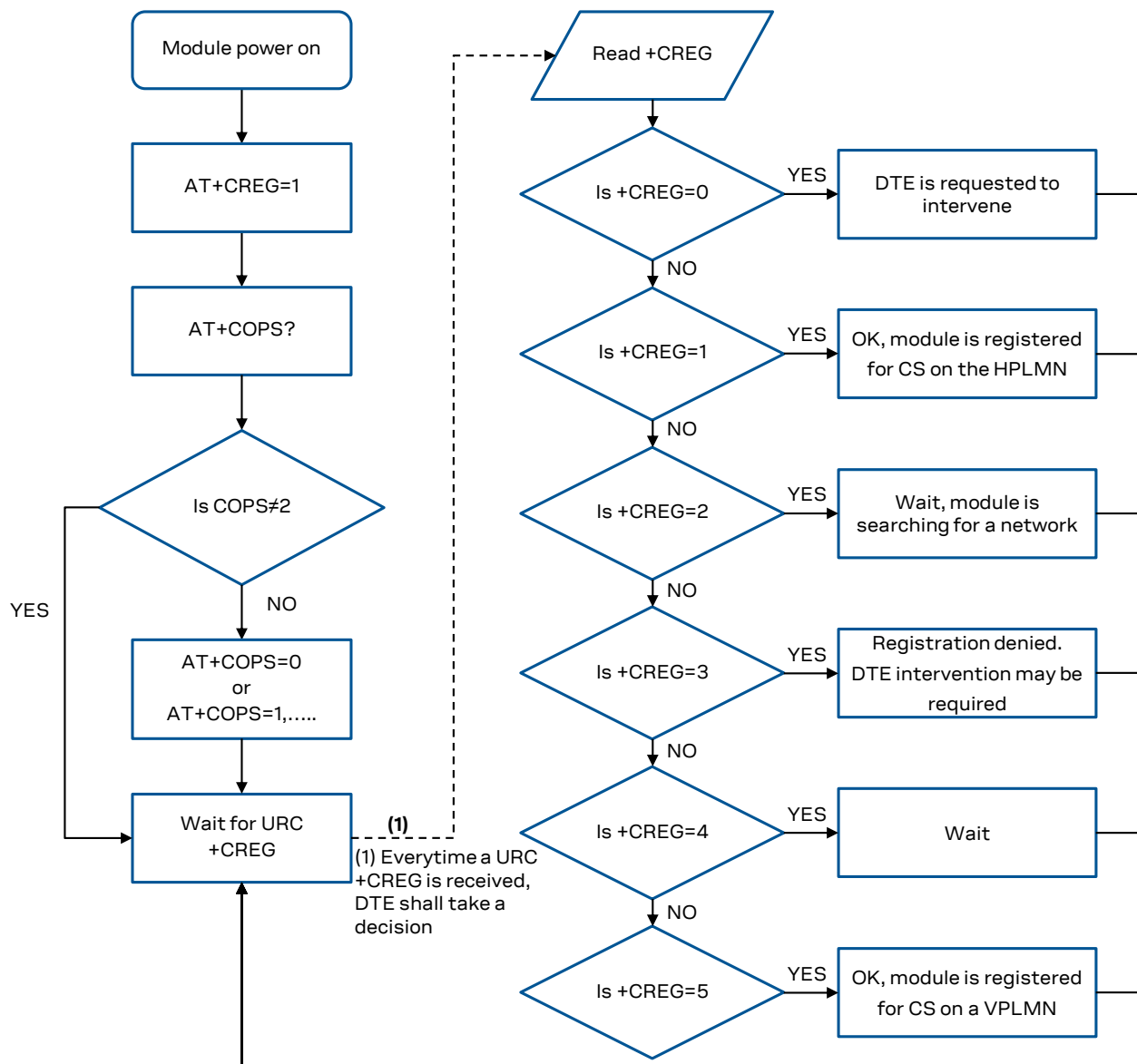



Figure 3: CS and PS network registration flow chart

-  When the indication +C(G/E)REG=5 is received, the DTE shall use +CGED (if available) to verify if the network is an Equivalent PLMN or not, and so it can determine its roaming status.
-  SARA-U2 and LISA-U2 series support the Equivalent Home PLMN feature (its activation depends on the USIM application; see the 3GPP TS 31.102 [10]). Thus the +C(G)REG=1 URC returned to DTE, may indicate that the module is not registered on the HPLMN but on a EHPLMN.

The following is an overview of the values assumed by the <stat> parameter in +CREG:

- 0: a technical problem may have occurred; the user is requested to intervene. It is still possible to make emergency calls if some network is available. Possible causes:
  - PIN not entered
  - SIM read error
  - SIM card not present

The registration is not started (+COPS=2)

- 1: the MT is registered on a HPLMN or an EHPLMN
- 2: the module is searching for a network to register on. Possible causes:
  - No network available
  - Available networks have insufficient Rx level
  - HPLMN or allowed PLMN are available but the registration is rejected, e.g. roaming is not allowed in this Location Area

It is still possible to make emergency calls if network coverage is available.

- 3: the registration fails after a Location Update Reject; possible causes are:
  - Illegal MS
  - Illegal ME
  - IMSI unknown at HLR
  - PLMN not allowed
  - Location area not allowed
  - Roaming not allowed in this location area
  - Network failure
  - Network congestion

It is still possible to make emergency calls if network coverage is available.

If the registration type is manual, then no further attempt is made to search for a new PLMN or register with it. If the registration type is automatic, the MS may look for an allowed PLMN if the rejection cause was roaming restriction. In case of illegal MS / ME, there could be possible problems with either the SIM card or with the MT's identity (IMEI): user intervention may be required.

- 4: this value, usually transitory, is returned if the registration state does not belong to any of the following:
  - Normal
  - Limited
  - No service
  - Service detached
  - Service disabled

A failed registration procedure can be seen before starting a PLMN search, when <stat>=2.

- 5: the MT is registered on a VPLMN (in national/international roaming, or on an EPLMN)

The following are the recommended actions for +CREG / +CGREG / +CEREG indications:

- <stat>=0: not registered, the MT is not currently searching a new operator to register to  
ACTION: send AT+COPS=0 to register, and once the module is registered (+CREG: 1), send AT+CGACT=1 to activate a new PDP context
- <stat>=1: registered, home network

ACTION: none required, but it is possible to verify with the +CGACT read command if the PDP context has been deactivated, and if so issue AT+CGACT=0 and then AT+CGACT=1 to ensure that a new PDP context is activated

- <stat>=2: not registered, but the MT is currently searching a new operator to register to  
ACTION: wait for +CREG: 1, no other action required, this is the case when the module has lost network coverage
- <stat>=3 and <stat>=4: the registration is denied or unknown, it is not possible to activate a PDP context  
ACTION: this may occur due to the module being unable to find signals for desired carrier, moving the device to another location may help, otherwise suggest recalling device for repair
- <stat>=5: registered, roaming  
ACTION: verify with the +CGACT read command if the PDP context has been deactivated, and if so issue AT+CGACT=0 and then AT+CGACT=1 to ensure that a new PDP context is activated

 In the case of multi-RAT LTE-enabled products, if the module is allowed to register using different RATs and LTE is preferred, in the case the module fails to perform the combined EPS/IMSI attach, it will fall back to a legacy RAT, such as UMTS or GPRS, according to the particular configuration of the +URAT AT command. In this case, LTE will be disabled, as depicted in section 4.1.4.2.

## 4.2.1 Recommendations on registration failure handling

A user intervention is required in any case of a permanent reject causes (for PS or CS services, depending on the type of application):

- MM/GMM Reject Cause #2 – IMSI Unknown in HLR
- MM/GMM Reject Cause #3 – Illegal MS
- MM/GMM Reject Cause #6 – Illegal ME
- GMM Reject Cause #7 – GPRS Services not allowed
- GMM Reject Cause #8 – GPRS Services and Non-GPRS Services not allowed
- EMM reject cause #3 - Illegal UE
- EMM reject cause #6 Illegal ME
- EMM reject cause #7 - EPS services not allowed
- EMM reject cause #8 - EPS services and non-EPS services not allowed

All these types of registration failures cause the service (only PS service for cause #7) to be unavailable until the device is restarted, e.g. via AT+CFUN=16 (SW reset), or via a power cycle or via a SIM removal and re-insertion (if SIM hot insertion is available and enabled).

AT+COPS=2/0 or AT+CFUN=4/1 cycles will have no effect, since they do not change the subscription state, marked as Invalid.

Since the module will not eventually regain service, the user application must reset the device with appropriate timings. If the service restriction is related to a SIM that has become invalid, it is not advisable to reset the device more than once every hour/day depending on the power consumption constraints (reboot and registration attempts increase the average power consumption).

If the permanent service restriction is due to roaming (some NW might use cause #8 instead of more appropriate reject cause with local meaning, e.g. #14 EPS services not allowed in this PLMN), the user application might retry more often in case of a mobile device; in stationary conditions (a sensor can assist in discriminating stationary from mobility case), the user application might be compelled to set the module in +COPS:1 and select another PLMN if the PLMN automatically selected by the UE is rejecting it with a permanent reject cause.

In any case, the user application should not trigger SW reset too often to avoid signaling overload. If the mounted SIM card is AT&T or if +URPM has been enabled, an automatic control on the maximum

number of SW reset per hour is done by the SW itself. Additional SW reset via AT command will be answered with ERROR.

In addition, after a given time (one hour on average) the RPM feature supported by the module will trigger an automatic reset to try to regain service. If RPM is not active and cannot be activated, similar concepts should be implemented by the user application.

### 4.3 Simultaneous support of data and voice services

LEON-G1

LISA-U2

SARA-G3

SARA-U2

TOBY-L2

TOBY-R2

LARA-R2

Another URC which is useful for monitoring the PS status is +CGEV which can be configured via +CGEREP; for more information, see the u-blox AT Commands Manual [1]. The URC +CGEV returns information about the GPRS mobile class (“A”, “B”, “CC” or “CG”, see +CGCLASS parameters description), the PDP context status and the GPRS attach status.

The GPRS mobile class is useful to understand if a product, by using a given RAT, is able to support data and voice traffic simultaneously. For a module registered to both PS and CS services, based on the current NW configuration the following situations can happen:

- 3G RAT: data and voice simultaneous traffic is supported (Class A);
- LTE RAT with 3G CSFB: data and voice simultaneous traffic is guaranteed through the fallback to the 3G RAT (Class A);
- LTE RAT with VoLTE: data and voice simultaneous traffic is guaranteed thanks to the use of the VoLTE technology (Class A);
- 2G RAT: data and voice simultaneous traffic is not supported. If a call starts during a data transfer, the data connectivity is suspended (Class B);
- LTE RAT with 2G CSFB: data and voice simultaneous traffic is not guaranteed because of the fallback to the 2G RAT. Usually, data traffic is suspended.

An exception to these general rules is the availability in 2G of the Dual Transfer Mode (DTM) feature, an extension to the GSM and GPRS standards that allows for simultaneous access to CS and PS services. In order to be assigned to the module, the DTM must be supported both by the module and by the network.

The +UCLASS AT command allows to verify if the module supports the DTM protocol (values 5, 9 or 11 with E/GPRS and GPRS multi-slot). On LARA-R211 it is supported but is disabled by default. On TOBY-L2 series, DTM is not supported.

The DTM support for the network can be checked through the +UREG AT command. If +UREG read command returns 8 or 9, the DTM is available.

### 4.4 Configurations for optimized power consumption

Beside power saving (see +UPSV AT command description and the related module system integration manual), some additional settings can be exploited to reduce the power consumption of the module.

LISA-U2

SARA-U2

TOBY-L2

TOBY-R2

LARA-R2

**+UFDAC** AT command controls the 3G Fast Dormancy feature, which is disabled by default on most modules. If enabled, the module will release the PS data channel, thus entering lower power consumption idle mode, if the transmission buffers are empty for a user defined time interval. The frequency of this mobile originated channel releases can be limited by the NW or by a user defined inhibition timer.

LISA-U270-62S / LISA-U270-63S / LISA-U270-68S have FD enabled by default, with fixed values of 2 s for the delay timer and 120 s for the inhibition timer.

Suggested values for optimized power consumption are 2 s for the delay timer and 5 s for the inhibition timer.

- Applications that need to have a short response time when sending data to a server shall not use Fast Dormancy because it might extend the transfer delay, or shall set the delay timer to a value higher than the period of the uplink transmission.
- Applications that have a non predictable bursty traffic profile but can accept a higher response time shall use Fast Dormancy with short delay time
- Applications that have full control on the data transmission periodicity can rely on one shot FD (AT+UFDAC=1) to be triggered when data transmission has ended.

LISA-U2

SARA-U2

Not supported by "00", "01", "02", "03", "53", "62", "63", "68", "73", "83" product versions.

**+UDCONF=55** AT command allows to reduce the frequency of the PLMN scan performed in out of service and in limited service conditions. The module will alternate timer1 periods of “normal” scan with timer2 periods of no scan.

- Timer2 has to be set to the maximum acceptable delay to retrieve reachability.
- Timer1 should be set to the maximum response time of registration AT commands (AT+COPS=0), i.e. 180 s.

#### PLMN search configuration

Command	Response	Description
AT+UDCONF=55	+UDCONF: 55,0,0 OK	Retrieve current values, by default the feature is disabled
AT+UDCONF=55,20,60	OK	If normal service cannot be achieved with periodic PLMN scan for 200 s, the module will prevent performing further PLMN scan for 10 minutes.

LISA-U2

SARA-U2

Not supported by "00", "01", "02", "03", "53", "62", "63", "68", "73", "83" product versions.

**+UDCONF=57** AT command enables a radio coverage manager that disables cellular functionality if the module cannot be reachable for timer1. The module will alternate higher power consumption periods of cell selection attempts (timer1) with timer2 periods of airplane mode.

- Timer2 has to be set to the maximum acceptable delay to retrieve reachability.
- Timer1 should be set to the maximum response time of registration AT commands (+COPS=0), i.e. 180 s, but it can be reduced if power consumption constraints are very strict.

This feature shall be activated in static conditions (no mobility).

Since it autonomously sets the module into airplane mode (+CFUN: 4), which is a persistent setting after reboot, when the user application regains full control on the module, it shall check the +CFUN status and re-establish cellular functionality via AT+CFUN=1 if needed.

---

**Smart radio coverage manager**

---

Command	Response	Description
AT+UDCONF=57	+UDCONF: 57, 0, 0 +UDCONF: 57, 1, 60, 600 +UDCONF: 57, 2, 20, 60 OK	By default the feature is disabled. By default timer1 is 60 s and timer2 600 s. Bu default 10 loss of coverage occurring within a couple of minutes are considered a high consuming
AT+UDCONF=57, 1, 30, 600	OK	Configure the timers: when the feature is enabled, if the device is not reachable for 30s, it will enter airplane mode. Cellular functionality will be re-started after timer2 s, i.e. 600 s in this case. Timer2 shall be selected based on the maximum tolerable period of service interruption.
AT+UDCONF=57, 2, 10, 25	OK	Configure the de-bouncing algorithm: if the device is in static conditions and periodically loses cell coverage 10 times in less than 250s, it will enter airplane mode. Cellular functionality will be re-started ca after timer1+timer2 s, i.e. 630 s in this case.
AT+UDCONF=57, 0, 1	OK	Enable the feature.
AT+UDCONF=57, 0, 0	OK	Disable the feature and re-establish full functionality (+CFUN: 1) if it was disabled in the meantime. To be used when the application processor has relaxed power consumption constraints and can autonomously handle the cellular connection.  The feature should be disabled to prevent automatic disabling of cellular functionality in a long tunnel or in temporary no coverage situations caused by mobility

---

## 5 PS data connection

### 5.1 External PDP context handling

LISA-U2
SARA-U2

This section explains how to define, activate and deactivate an external Packet Data Protocol (PDP) context, i.e. a data connection using the external IP stack (e.g. Windows dial up) and PPP over the communication port (UART/USB).

#### 5.1.1 External PDP context definition and activation

An external PDP context can be defined with `+CGDCONT` and then activated with `+CGACT`, `+CGDATA="PPP", <cid>` or `ATD*99***<cid>#` (dial up).

The maximum number of definable PDP contexts is 3.

The `+CGQREQ` and `+CGEQREQ` (for the 3G network) AT commands configure the parameter `<cid>` that identifies the Quality of Service (QoS) profile for the PDP context. A QoS profile can be specified after the PDP context definition it is associated to and before its activation.

A minimum acceptable QoS profile for a PDP context may be specified with `+CGQMIN` and `+CGEQMIN` AT commands. However, the usage of these commands should be restricted to the cases where minimum QoS parameters are specifically constrained by the external application.

Command	Response	Description
<code>AT+CGDCONT=1,"IP","web.omnitel.it"</code>	OK	Define the PDP context 1 with PDP type "IP" and APN "web.omnitel.it".
<code>AT+CGDCONT=3,"IP","internet"</code>	OK	Define the PDP context 3 with PDP type "IP" and APN "internet".
<code>AT+CGDCONT=2,"IP","mms.vodafone.it"</code>	OK	Define the PDP context 2 with PDP type "IP" and APN "mms.vodafone.it".
<code>AT+CGDCONT?</code>	+CGDCONT: 1,"IP","web.omnitel.it", "0.0.0.0",0,0 +CGDCONT: 3,"IP","internet", "0.0.0.0",0,0 +CGDCONT: 2,"IP","mms.vodafone.it", "0.0.0.0",0,0 OK	Read the PDP contexts' parameters.
<code>AT+CGEQREQ=1,3,64,64,,0,320,"1E4","1E5",1,,3</code>	OK	Define a QoS profile for PDP context 1, with Traffic Class 3 (background), maximum bit rate 64 kb/s both for UL and for DL, no Delivery Order requirements, a maximum SDU size of 320 octets, an SDU error ratio of 10 <sup>-4</sup> , a residual bit error ratio of 10 <sup>-5</sup> , delivery of erroneous SDUs allowed and Traffic Handling Priority 3.
<code>AT+CGQREQ=2,1,3,4,5,6</code>	OK	Define a QoS profile for PDP context 2, with Precedence Class 1, Delay Class 3, Reliability Class 4, Peak Throughput Class 5 and Mean Throughput Class 6.
<code>AT+CGACT=1,1</code>	OK	PDP context 1 activation (alternatively with <code>AT+CGDATA="PPP", 1</code> or <code>ATD*99***1#</code> ).
<code>AT+CGPADDR=1</code>	+CGPADDR: 1, "91.80.104.82" OK	Show address of PDP context 1. If PPP is used this command shall be sent from another AT command interface.



Command	Response	Description
AT+CGDCONT?	+CGDCONT: 1,"IP","web.omnitel.it", "91.80.104.82",0,0 +CGDCONT: 3,"IP","internet", "0.0.0.0",0,0 +CGDCONT: 2,"IP","mms.vodafone.it", "0.0.0.0",0,0 OK	Read the PDP contexts' parameters.
AT+CGEQNEG=1	+CGEQNEG: 1,3,64,64,0,0,0,320,"1E4", "1E5",1,1000,3,0,0 OK	Read the negotiated QoS profile for the PDP context 1.
AT+CGACT=0,1	OK	PDP context 1 deactivation.
AT+CGDCONT?	+CGDCONT: 1,"IP","web.omnitel.it", "0.0.0.0",0,0 +CGDCONT: 3,"IP","internet", "0.0.0.0",0,0 +CGDCONT: 2,"IP","mms.vodafone.it", "0.0.0.0",0,0 OK	Read the PDP contexts' parameters.
AT+CGACT=1	OK	All defined PDP contexts activation.
AT+CGDCONT?	+CGDCONT: 1,"IP","web.omnitel.it", "91.80.101.207",0,0 +CGDCONT: 3,"IP","internet", "83.225.114.136",0,0 +CGDCONT: 2,"IP","mms.vodafone.it", "10.159.135.60",0,0 OK	Read the PDP contexts' parameters: all PDP contexts have different PDP addresses.
AT+CGEQNEG=2	+CGEQNEG: 2,2,128,128,0,0,0,1500,"1E3", "1E5",0,1000,3,0,0 OK	Read the negotiated QoS profile for the PDP context 2.
AT+CGACT=0	OK	All defined PDP contexts deactivation.
AT+CGDCONT?	+CGDCONT: 1,"IP","web.omnitel.it", "0.0.0.0",0,0 +CGDCONT: 3,"IP","internet", "0.0.0.0",0,0 +CGDCONT: 2,"IP","mms.vodafone.it", "0.0.0.0",0,0 OK	Read the PDP contexts' parameters.
AT+CGACT=1,2	OK	PDP context 2 activation.
AT+CGDCONT?	+CGDCONT: 1,"IP","web.omnitel.it", "0.0.0.0",0,0 +CGDCONT: 3,"IP","internet", "0.0.0.0",0,0 +CGDCONT: 2,"IP","mms.vodafone.it", "10.153.123.229",0,0 OK	Read the PDP contexts' parameters.

### 5.1.1.1 Secondary PDP context definition and activation

A secondary PDP context is an external PDP context associated with a primary external PDP context and sharing the same PDP address and APN with it. The primary and the associated secondary PDP contexts are typically used to provide connection to the same PDN (Packet Data Network) with different guaranteed QoS.

The typical usage of the secondary PDP contexts is in VoIP calls, where RTP (speech) packets are conveyed on one PDP context (e.g. the primary one) with a given QoS (e.g. low reliability) whereas SIP signaling is routed on a different PDP context (e.g. the secondary one, with the same IP address but different port numbers) with a more reliable QoS.

The +CGDSCONT AT command defines the secondary PDP contexts. Since the maximum number of definable PDP contexts is three, the maximum number of definable secondary PDP contexts is two.

The primary PDP context must be activated before activating an associated secondary PDP context.

In addition, before a secondary PDP context activation, at least one Packet Filter (PF) for a Traffic Flow Template (TFT) must be defined with the +CGTFT AT command.

The TFT is stored by the GGSN and it is examined when routing downlink user plane data. A TFT incorporates from one to eight PF, each characterized by a Packet Filter Identifier (PFI) and an Evaluation Precedence Index (EPI). The EPI specifies the precedence class among all PFs associated with a PDP address. Any incoming packet is first checked against the PF with lowest EPI and, in case no match is found, it is matched against the PF with the next highest EPI.

A valid packet filter must contain a unique identifier (within all PFs for a given TFT) and a unique evaluation precedence index (within all TFTs for one PDP address). If a PF is defined, with a PFI which already identifies another PF for the same TFT, the second PF overwrites the first, so that all PFIs are unique within a TFT.

In addition, at least one of the following parameters must be included for a TFT definition:

- <source\_address\_and\_subnet\_mask>
- <protocol\_number\_(ipv4)-next\_header\_(ipv6)>
- <destination\_port\_range>
- <source\_port\_range>
- <ipsec\_security\_parameter\_index\_(spi)>
- <type\_of\_service\_(tos)\_(ipv4)\_and\_mask-traffic\_class\_(ipv6)\_and\_mask>
- <flow\_label (ipv6)>

The allowed combinations are:

- Combination 1:
  - <source\_address\_and\_subnet\_mask>
  - <protocol\_number\_(ipv4)-next\_header\_(ipv6)>
  - <destination\_port\_range>
  - <source\_port\_range>
  - <type\_of\_service\_(tos)\_(ipv4)\_and\_mask-traffic\_class\_(ipv6)\_and\_mask>
- Combination 2:
  - <source\_address\_and\_subnet\_mask>
  - <protocol\_number\_(ipv4)-next\_header\_(ipv6)>
  - <ipsec\_security\_parameter\_index\_(spi)>
  - <type\_of\_service\_(tos)\_(ipv4)\_and\_mask-traffic\_class\_(ipv6)\_and\_mask>
- Combination 3:
  - <source\_address\_and\_subnet\_mask>
  - <type\_of\_service\_(tos)\_(ipv4)\_and\_mask-traffic\_class\_(ipv6)\_and\_mask>
  - <flow\_label (ipv6)>

The secondary PDP contexts can be defined and activated as follows:

Command	Response	Description
AT+CGDCONT=1,"IP","web.omnitel.it"	OK	Define the primary PDP context 1.
AT+CGEQREQ=1,4,32,32,,0,320,"1E4","1E5",1,,1	OK	Define a QoS profile for PDP context 1, with Traffic Class 4 (subscribed value), maximum bit rate 32 kb/s both for UL and for DL, no Delivery Order requirements, a maximum SDU size of 320 octets, an SDU error ratio of 10 <sup>-4</sup> , a residual bit error ratio of 10 <sup>-5</sup> , delivery of erroneous SDUs allowed and Traffic Handling Priority 1.

Command	Response	Description
AT+CGDSCONT=2,1	OK	Define a secondary PDP context with context identifier 2 associated to the primary PDP context with context identifier 1.
AT+CGEQREQ=2,3,64,64,,,0,320,"1E4","1E5",1,,2		Define a QoS profile for secondary PDP context 2, with Traffic Class 3 (background), maximum bit rate 64 kb/s both for UL and for DL, no Delivery Order requirements, a maximum SDU size of 320 octets, an SDU error ratio of 10 <sup>-4</sup> , a residual bit error ratio of 10 <sup>-5</sup> , delivery of erroneous SDUs allowed and Traffic Handling Priority 2.
AT+CGDSCONT=3,1	OK	Define a secondary PDP context with context identifier 3 associated to the primary PDP context with context identifier 1.
AT+CGEQREQ=3,2,64,64,,,0,320,"1E4","1E5",1,,3,,0	OK	Define a QoS profile for secondary PDP context 3, with Traffic Class 2 (Interactive), maximum bit rate 64 kb/s both for UL and for DL, no Delivery Order requirements, a maximum SDU size of 320 octets, an SDU error ratio of 10 <sup>-4</sup> , a residual bit error ratio of 10 <sup>-5</sup> , delivery of erroneous SDUs allowed, and Traffic Handling Priority 3.  Since the Traffic Class is set to "Interactive" the last parameter, "Signaling Indicator", has to be specified too: in this case it is set to 0 (PDP context is not optimized for signaling).
AT+CGDCONT?	+CGDCONT: 1,"IP","web.omnitem.l.it","0.0.0.0",0,0 +CGDCONT: 2,"IP","","0.0.0.0",0,0 +CGDCONT: 3,"IP","","0.0.0.0",0,0 OK	Read PDP contexts' parameters.
AT+CGACT=1,2	+CME ERROR: operation not allowed	The secondary PDP context 2 cannot be activated before the primary PDP context 1 activation and before a Traffic Flow Template definition for PDP context 2 (with +CGTFT command).
AT+CGACT=1,1	OK	Primary PDP context 1 activation (alternatively with AT+CGDATA="PPP",1 or ATD*99**1#).
AT+CGDCONT?	+CGDCONT: 1,"IP","web.omnitem.l.it","91.80.104.82",0,0 +CGDCONT: 2,"IP","","0.0.0.0",0,0 +CGDCONT: 3,"IP","","0.0.0.0",0,0 OK	Read PDP contexts' parameters. If PPP is used this command shall be sent from another AT command interface.
AT+CGEQNEG=1	+CGEQNEG: 1,2,32,32,0,0,0,320,"1E4","1E5",1,1000,1,0,0 OK	Read the negotiated QoS profile for PDP context 1.
AT+CGTFT=2,1,1,"109.115.145.113.255.255.0.0"	OK	Define a PF for PDP context 2. The packet filter identifier is 1 (second parameter), the evaluation precedence index is 1 (third parameter).  This PF applies to all packets with source address "109.115.145.113" and subnet mask "255.255.0.0".
AT+CGTFT=2,2,3,"91.80.105.10.255.255.0.0",,"65435.65535",,"65235.65335"	OK	Defines another PF for PDP context 2. The packet filter identifier is 2 (second parameter), the evaluation precedence index is 3 (third parameter). This PF applies to all packets with source address "91.80.105.10", subnet mask

Command	Response	Description
		"255.255.0.0", destination port range "65435.65535" and source port range "65235.65335".
AT+CGTFT=2,3,2,"71.40.10.10.255.255.0.0"	OK	Defines another PF for PDP context 2. The packet filter identifier is 3; the evaluation precedence index is 2. This PF applies to all packets with source address "71.40.10.10" and subnet mask "255.255.0.0".
AT+CGACT=1,2	OK	Activate secondary PDP context 2 (alternatively with AT+CGDATA="PPP", 2 or ATD*99**2#).
AT+CGDCONT?	+CGDCONT: 1,"IP","web.omnitel.it","91.80.104.82",0,0 +CGDCONT: 2,"IP","","91.80.104.82",0,0 +CGDCONT: 3,"IP","","0.0.0.0",0,0 OK	Read PDP contexts' parameters: PDP contexts 1 and 2 share the same PDP address.
AT+CGEQNEG=2	+CGEQNEG: 2,3,64,64,0,0,320,"1E4","1E5",1,1000,2,0,0 OK	Read the negotiated QoS profile for PDP context 2.
AT+CGTFT=3,4,4,"105.110.145.113.255.255.0.0",,"65435.65535",,"65235.65335"	OK	Defines a PF for the PDP context 3. The packet filter identifier is 4 (second parameter), the evaluation precedence index is 4 (third parameter). This PF applies to all packets with source address "105.110.145.113", subnet mask "255.255.0.0", destination port range "65435.65535" and source port range "65235.65335".
AT+CGACT=1,3	OK	Activate secondary PDP context 3.
AT+CGDCONT?	+CGDCONT: 1,"IP","web.omnitel.it","91.80.104.82",0,0 +CGDCONT: 2,"IP","","91.80.104.82",0,0 +CGDCONT: 3,"IP","","91.80.104.82",0,0 OK	Read PDP contexts' parameters: all PDP contexts share the same PDP address.
AT+CGTFT=2	OK	The PF for context identifier 2 becomes undefined.
AT+CGDCONT?	+CGDCONT: 1,"IP","web.omnitel.it","91.80.104.82",0,0 +CGDCONT: 2,"IP","","91.80.104.82",0,0 +CGDCONT: 3,"IP","","91.80.104.82",0,0 OK	Read PDP contexts' parameters: PDP context 2 is still active.
AT+CGACT=0,3	OK	Deactivate secondary PDP context 3.
AT+CGDCONT?	+CGDCONT: 1,"IP","web.omnitel.it","91.80.104.82",0,0 +CGDCONT: 2,"IP","","91.80.104.82",0,0 +CGDCONT: 3,"IP","","0.0.0.0",0,0 OK	Read PDP contexts' parameters: PDP context 3 is not active.
AT+CGACT=0	OK	Deactivate all the PDP contexts.
AT+CGDCONT?	+CGDCONT: 1,"IP","web.omnitel.it","","0,0 +CGDCONT: 3,"IP","","0.0.0.0",0,0 +CGDCONT: 2,"IP","","0.0.0.0",0,0 OK	Read PDP contexts' parameters: no PDP context is active.

## 5.2 Secondary PDP context definition and activation in ROUTER mode

### TOBY-L2

A secondary PDP context is an external PDP context associated with a primary external PDP context and sharing the same PDP address and APN with it. The primary and the associated secondary PDP contexts are typically used to provide connection to the same PDN (Packet Data Network) with different guaranteed QoS.

In the following example, an application needs to define one primary context and three secondary contexts with specific bandwidths:

- one context with 20 kb/s bandwidth
- one context with 10 kb/s bandwidth
- one context for video streaming
- one default context for general connectivity

Be aware that the activation of secondary PDP contexts depends on network operators.

Command	Response	Description
AT+CFUN=4	OK	Set the airplane mode.
AT+UCGDFLT=1, "IP", "test"	OK	Define the default primary PDP context (<cid>=4).
AT+CFUN=1	OK	Set the module to full mode.
AT+CGDCONT?	+CGDCONT: 4, "IP", "test", "192.168.1.11", 0, 0, 0, 0, 0, 0 OK	
AT+CGDSCONT=1, 4	OK	Define a secondary PDP context with context identifier 1 associated to the primary PDP context with context identifier 4.
AT+CGEQOS=1, 4, 20, 20, 20, 20	OK	Specify the EPS Quality of Service parameters for secondary PDP context with <cid>=1. Downlink and uplink guaranteed bit rate (GBR) is 20 kb/s. Downlink and uplink maximum bit rate (MBR) is 20 kb/s.
AT+CGDSCONT=2, 4	OK	Define a secondary PDP context with context identifier 2 associated to the primary PDP context with context identifier 4.
AT+CGEQOS=2, 4, 10, 10, 10, 10	OK	Specify the EPS Quality of Service parameters for secondary PDP context with <cid>=2. Downlink and uplink guaranteed bit rate (GBR) is 10 kb/s. Downlink and uplink maximum bit rate (MBR) is 10 kb/s.
AT+CGDSCONT=3, 4	OK	Define a secondary PDP context with context identifier 1 associated to the primary PDP context with context identifier 4.
AT+CGEQOS=3, 6	OK	Specify the EPS Quality of Service parameters for secondary PDP context with <cid>=3: QCI=6 is used for video streaming (non-guaranteed bit rate).
AT+CGTFT=1, 1, 0, "151.9.34.91.255.255.255.255"	OK	Set the packet filter for a traffic flow template for context <cid>=1: it specifies the source address (151.9.34.91) and subnet mask (255.255.255.255) attribute of a valid packet filter (1).
AT+CGTFT=2, 1, 0, "151.9.34.91.255.255.255.255"	OK	Set the packet filter for a traffic flow template for context <cid>=2: it specifies the source

Command	Response	Description
		address (151.9.34.91) and subnet mask (255.255.255.255) attribute of a valid packet filter (1).
AT+CGTFT=3,1,0,"151.9.34.91.255.255.255.255"	OK	Set the packet filter for a traffic flow template for context <cid>=3: it specifies the source address (151.9.34.91) and subnet mask (255.255.255.255) attribute of a valid packet filter (1).
AT+CGACT=1,1	OK	Secondary PDP context 1 activation (alternatively with AT+CGDATA="PPP", 1 or ATD*99***1#).
AT+CGACT=1,2	OK	Secondary PDP context 2 activation (alternatively with AT+CGDATA="PPP", 1 or ATD*99***1#).
AT+CGACT=1,3	OK	Secondary PDP context 3 activation (alternatively with AT+CGDATA="PPP", 1 or ATD*99***1#).
AT+CGDCONT?	+CGDCONT: 1,"IP","", "192.168.1.11",0,0,0,0,0,0 +CGDCONT: 2,"IP","", "192.168.1.11",0,0,0,0,0,0 +CGDCONT: 3,"IP","", "192.168.1.11",0,0,0,0,0,0 +CGDCONT: 4,"IP","test", "192.168.1.11",0,0,0,0,0,0 OK	Read PDP contexts' parameters. If PPP is used this command shall be sent from another AT command interface.







## 5.3 Internal PDP context activation

LEON-G1
LISA-U2
SARA-G3
SARA-G4
SARA-U2
TOBY-L2
TOBY-R2
LARA-R2

- Not supported by SARA-G300 / SARA-G310 modules.
- For TOBY-L201 and LARA-R204 in Verizon configuration, see the section [5.3.1](#) and [10.11](#).
- Be aware that network operators could deny the activation of different PDP context with the same APN, see the section [5.5](#).

Perform the configuration of a data connection for FTP, HTTP, SMTP and TCP/IP AT commands as follows:

Command	Response	Description
AT+CGATT?	+CGATT: 1 OK	Check the GPRS attach status. The first parameter indicated the GPRS status (in this case 1 - GPRS attached).
		Create a GPRS connection profile for TCP/IP with the +UPSD AT command. This will be made in 2 steps: <ol style="list-style-type: none"> <li>1. Set up the APN.</li> <li>2. Specify to use the dynamic IP address assignment.</li> </ol> It is possible to configure up to 7 GPRS profiles. An identifier (an integer value from 0 to 6) identifies each profile. The profile

Command	Response	Description
		identifier is the first parameter of +UPSND, +UPSD, +UPSDA AT commands.  The +UPSD AT command does not affect the GPRS profiles created with +CGDCONT command.
AT+UPSND=0,8	+UPSND: 0,8,0 OK	Check the status of the GPRS connection profile associated to GPRS connection profile identifier "0". The GPRS profile status is provided by the third parameter (in this case 0 - not active).  This step is not mandatory.
AT+UPSD=0,1,"web.omnitel.it"	OK	Set up APN for GPRS connection profile "0".  APN "web.omnitel.it" is an example only. Use the APN operator.
AT+UPSD=0,7,"0.0.0.0"	OK	Set up the dynamic IP address assignment.
AT+UPSDA=0,1	OK	Save the GPRS profile in the NVM.  This step is not mandatory.
AT+UPSDA=0,3	OK	Activate the GPRS connection. It is suggested to enter this command in PS registered status i.e. +CGATT:1, otherwise the +UPSDA AT command might have a longer response time due to the concatenation of signaling procedures not always handled by the cellular networks.
AT+UPSND=0,8	+UPSND: 0,8,1 OK	Check the status of the GPRS connection profile associated to GPRS connection profile identifier "0". The GPRS profile status is provided by the third parameter (in this case 1 - active).  This step is not mandatory.
AT+UPSND=0,0	+UPSND: 0,0,"93.68.225.175" OK	Check the assigned IP address.  In this example the assigned dynamic IP address is requested.

### 5.3.1 PDP contexts activation on Verizon Mobile Network Operator

**TOBY-L201**

**LARA-R204**

The Verizon Wireless (VZW) is associated with 4 APNs, i.e. APN Class 1 (APN1), APN Class 2 (APN2), APN Class 3 (APN3) and APN Class 4 (APN4).

APN1 is the initial default bearer, and it should not be changed by the user/application. APN2 is used for the BIP provisioning, and it should not be changed, too. APN4 is reserved, too.

For data connectivity purposes, the user/application is entitled to use only the APN3, whose default value is "VZWINTERNET". Using a particular SIM card, usually the APN3 value is provisioned over the air through the OMA-DM protocol, and its value can be retrieved through the +VZWAPNE read command.

 To use Verizon private or enterprise APNs (i.e. VZWENTP), an appropriate private network SIM is needed. A standard public Verizon SIM cannot use private or enterprise APNs. In this case, the public APN VZWINTERNET must be used.

When a new context activation is required, check that the automatic MNO configuration is selected, through the +UMNOCONF AT command (this is the default value on VZW). If this is not the case, a

particular cellular module can select the VZW MNO either in automatic mode (AT+UMNOCONF=1,23) or by explicitly selecting it (AT+UMNOCONF=3,23).

Moreover, it is advised to enable all the useful URCs to monitor CS and PS data registration and changes (AT+CMEE=2;+CEREG=3;+CREG=2;+CGREG=2;+CGEREP=2,1; AT+UOMASTAT=1).

The BIP provisioning occurs on APN2, so in case APN provisioning is occurring and the previous URCs are enabled the user will see activation and deactivation of the administrative context and also +UUOMASTAT URCs.

Be aware that the APN provisioning to work, the correct date and time must be set on the module. To this aim, issue the AT+CTZU=1 command.

If the APN provisioning is successful, the information text response to the +VZWAPNE read command will show that APN3 value is changed.

In case the APN3 handling is disabled in VZW connection manager (AT+UMNOCONF=0), if the correct APN3 value is known, use it with +CGDCONT and change the PDP context associated to APN3 if already available or use a free Context ID (CID).

Specifically, the following steps should be performed to enable an internal PDP context.

External APN3 context enabled		
Command	Response	Description
AT+CGDCONT?	+CGDCONT: 1,"IP","vzwadmin.mnc480.mcc311.gprs","10.133.171.106",0,0,0,0,0 +CGDCONT: 2,"IPV4V6","vzwinternnet.mnc480.mcc311.gprs","100.113.214.183 38.0.16.18.177.8 1.223.252.0.0.0.89.224.106.173.1",0,0,0,0,0 +CGDCONT: 4,"IPV6","vzwims.mnc480.mcc311.gprs","38.0.16.18.129.79.165.183.0.0.0.89.224.106.141.1",0,0,0,0,0 OK	Check the current active contexts. The APN3 on CID #2 is already enabled.
AT+UPSD=0	+UPSD: 0,0,2 +UPSD: 0,1,"" +UPSD: 0,100,2 OK	The internal context '0' is mapped on cid=2, where is APN3
AT+UPSDA=0,3	OK	Activate normally the internal context #0.
	+UUPSDA: 0,"100.113.214.183"	Context activated with the given IP address.

External APN3 context NOT enabled		
Command	Response	Description
AT+CGDCONT?	+CGDCONT: 1,"IP","vzwadmin.mnc480.mcc311.gprs","10.133.132.170",0,0,0,0,0 +CGDCONT: 2,"IPV4V6","vzwinternnet.mnc480.mcc311.gprs","",0,0,0,0,0 +CGDCONT: 4,"IPV6","vzwims.mnc480.mcc311.gprs","38.0.16.18.129.79.165.183.0.0.0.89.224.106.141.1",0,0,0,0,0 OK	Check the current active contexts. The APN3 on CID #2 is not enabled.
AT+UPSD=0	+UPSD: 0,0,2 +UPSD: 0,1,"" +UPSD: 0,100,2 OK	The internal context '0' is mapped on cid=2, where is APN3.



External APN3 context NOT enabled		
AT+UPSD=0,1,"VZWINTERNET"	OK	The external context is not active, thus the APN3 must be set.
AT+UPSDA=0,3	OK	Activate normally the internal context #0.
	+UUPSDA: 0,"100.97.138.97"	Context activated with the given IP address.
AT+CGDCONT?	+CGDCONT: 1,"IP","vzwadmin.mnc480.mcc311.gprs","",0,0,0,0,0,0 +CGDCONT: 2,"IPV4V6","vzwinternet.mnc480.mcc311.gprs","100.97.138.97 38.0.16.18.177.70.41.96.0.0.0.89.224.106.157.1",0,0,0,0,0,0 +CGDCONT: 4,"IPV6","vzwims.mnc480.mcc311.gprs","38.0.16.18.129.79.165.183.0.0.0.89.224.106.141.1",0,0,0,0,0,0	The context CID #2 is now activated.
	OK	

Verizon MNO does not allow to define multiple contexts using the same APN.

## 5.4 Context deactivation

LEON-G1

LISA-U2

SARA-G3

SARA-G4

SARA-U2

TOBY-R2

LARA-R2

Not supported by SARA-G300 / SARA-G310 modules.

### 5.4.1 Context deactivation by the network

Command	Response	Description
	+UUPSD: 0	A URC indicates PDP context #0 is closed by the network.

### 5.4.2 Context deactivation by the module

Command	Response	Description
AT+UPSDA=0,4	OK	Detach the GPRS profile identified by the first parameter of the command (in this case 0).

## 5.5 Using sockets on an already activated PDP context

TOBY-L2

Command	Response	Description
<b>The network assigns IPv4v6 address</b>		
AT+CGDCONT=8,"IPV4V6","apn_name"	OK	Define the PDP context 8 with PDP type "IPV4V6" and APN "apn_name".
AT+CGACT=1,8	OK	PDP context 8 activation: the IPv4v6 address is assigned by the network.
AT+CGDCONT?	+CGDCONT: 8,"IPV4V6","apn_name","100.108.232.233 38.0.16.3.177.33.116.198.0.0.0.3.107.232.191.1",0,0,0,0,0,0	Return both IPv4 (100.108.232.233) and IPv6 (38.0.16.3.177.33.116.198.0.0.0.3.107.232.191.1) addresses.
	OK	

Command	Response	Description
AT+UPSD=0,100,8	OK	Profile #0 is mapped on CID=8.
AT+UPSD=0,0,2	OK	Set the PDP type to IPv4v6 with IPv4 preferred for internal sockets.
AT+UPSDA=0,3	OK	Activate the PSD profile #0: IPv4v6 address already assigned by the network.
	+UUPSDA: 0,"100.108.232.233"	URC indicating that the PSD profile #0 has been successfully activated and the IPv4 assigned to the activated PDP context.
<b>The network assigns IPv4v6 address</b>		
AT+CGDCONT=8,"IPV4V6","apn_name"	OK	Define the PDP context 8 with PDP type "IPV4V6" and APN "apn_name".
AT+CGACT=1,8	OK	PDP context 8 activation: IPv4v6 address assigned by the network.
AT+CGDCONT?	+CGDCONT: 8,"IPV4V6","apn_name","100.108.232.233 38.0.16.3.177.33.116.198.0.0.0.3.107.232.191.1",0,0,0,0,0	Return both IPv4 (100.108.232.233) and IPv6 (38.0.16.3.177.33.116.198.0.0.0.3.107.232.191.1) addresses.
AT+UPSD=0,100,8	OK	Profile #0 is mapped on CID=8.
AT+UPSD=0,0,3	OK	Set the PDP type to IPv4v6 with IPv6 preferred for internal sockets.
AT+UPSDA=0,3	OK	Activate the PSD profile #0: IPv4v6 address already assigned by the network.
	+UUPSDA: 0,"38.0.16.3.177.33.116.198.0.0.0.3.107.232.191.1"	URC indicating that the PSD profile #0 has been successfully activated and the IPv6 assigned to the activated PDP context.
<b>The network assigns IPv4 address only</b>		
AT+CGDCONT=8,"IPV4V6","apn_name"	OK	Define the PDP context 8 with PDP type "IPV4V6" and APN "apn_name".
AT+CGACT=1,8	OK	PDP context 8 activation: only IPv4 address is assigned by the network.
AT+CGDCONT?	+CGDCONT: 8,"IP","apn_name","100.108.232.233",0,0,0,0,0	Return IPv4 address.
AT+UPSD=0,100,8	OK	Profile #0 is mapped on CID=8.
AT+UPSD=0,0,3	OK	Set the PDP type to IPv4v6 with IPv6 preferred for internal sockets.
AT+UPSDA=0,3	+CME ERROR: IP type configuration mismatch	Return an error result code because is detected a mismatch among the IPv4 assigned by the network and the preference for using an IPv6 in internal sockets.
AT+UPSD=0,0,0	OK	Set the PDP type to IPv4 referring the output of the +CGDONT read command.
AT+UPSDA=0,3	OK	Activate the PSD profile #0: IPv4 address already assigned by the network.
	+UUPSDA: 0,"100.108.232.233"	URC indicating that the PSD profile #0 has been successfully activated and the IPv4 assigned to the activated PDP context.
<b>The network assigns IPv6 address only</b>		
AT+CGDCONT=8,"IPV4V6","apn_name"	OK	Define the PDP context 8 with PDP type "IPV4V6" and APN "apn_name".
AT+CGACT=1,8	OK	PDP context 8 activation: only IPv6 address is assigned by the network.
AT+CGDCONT?	+CGDCONT: 8,"IP","apn_name","38.0.16.3.177.33.116.198.0.0.0.3.107.232.191.1",0,0,0,0,0	Return IPv6 address.
	OK	

Command	Response	Description
AT+UPSD=0,100,8	OK	Profile #0 is mapped on CID=8.
AT+UPSD=0,0,2	OK	Set the PDP type to IPv4v6 with IPv4 preferred for internal sockets.
AT+UPSDA=0,3	+CME ERROR: IP type configuration mismatch	Return an error result code because is detected a mismatch among the IPv6 assigned by the network and the preference for using an IPv4 in internal sockets.
AT+UPSD=0,0,1	OK	Set the PDP type to IPv6 referring the output of the +CGDONT read command.
AT+UPSDA=0,3	OK	Activate the PSD profile #0: the IPv6 address already assigned by the network.
	+UUPSDA: 0,"38.0.16.3.177.33.116.198.0.0.0.3.107.232.191.1"	URC indicating that the PSD profile #0 has been successfully activated and the IPv6 assigned to the activated PDP context.

**TOBY-R2**
**LARA-R2**

Command	Response	Description
<b>The network assigns IPv4v6 address</b>		
AT+CGDCONT=1,"IPV4V6","apn_name"	OK	Define the PDP context 1 with PDP type "IPV4V6" and APN "apn_name".
AT+CGACT=1,1	OK	PDP context 1 activation: the IPv4v6 address is assigned by the network.
AT+CGDCONT?	+CGDCONT: 1,"IPV4V6","apn_name","100.144.1.68 38.0.16.3.177.33.116.198.0.0.0.3.107.232.191.1",0,0,0,0,0	Return both IPv4 (100.108.232.233) and IPv6 (38.0.16.3.177.33.116.198.0.0.0.3.107.232.191.1) addresses.
AT+UPSD=0,100,1	OK	Profile #0 is mapped on CID=1.
AT+UPSD=0,0,2	OK	Set the PDP type to IPv4v6 with IPv4 preferred for internal sockets.
AT+UPSDA=0,3	OK	Activate the PSD profile #0: IPv4v6 address already assigned by the network.
	+UUPSDA: 0,"100.108.232.233"	URC indicating that the PSD profile #0 has been successfully activated and the IPv4 assigned to the activated PDP context.
<b>The network assigns IPv4v6 address</b>		
AT+CGDCONT=1,"IPV4V6","apn_name"	OK	Define the PDP context 1 with PDP type "IPV4V6" and APN "apn_name".
AT+CGACT=1,1	OK	PDP context 1 activation: the IPv4v6 address is assigned by the network.
AT+CGDCONT?	+CGDCONT: 1,"IPV4V6","apn_name","100.108.232.233 38.0.16.3.177.33.116.198.0.0.0.3.107.232.191.1",0,0,0,0,0	Return both IPv4 (100.108.232.233) and IPv6 (38.0.16.3.177.33.116.198.0.0.0.3.107.232.191.1) addresses.
AT+UPSD=0,100,1	OK	Profile #0 is mapped on CID=1.
AT+UPSD=0,0,3	OK	Set the PDP type to IPv4v6 with IPv6 preferred for internal sockets.
AT+UPSDA=0,3	OK	Activate the PSD profile #0: IPv4v6 address already assigned by the network.
	+UUPSDA: 0,"38.0.16.3.177.33.116.198.0.0.0.3.107.232.191.1"	URC indicating that the PSD profile #0 has been successfully activated and the IPv6 assigned to the activated PDP context.
<b>The network assigns IPv4 address only</b>		
AT+CGDCONT=1,"IPV4V6","apn_name"	OK	Define the PDP context 1 with PDP type "IPV4V6" and APN "apn_name".

Command	Response	Description
AT+CGACT=1,1	OK	PDP context 1 activation: only IPv4 address is assigned by the network.
AT+CGDCONT?	+CGDCONT: 1,"IP","apn_name", 100.108.232.233",0,0,0,0,0,0 OK	Return IPv4 address.
AT+UPSD=0,100,1	OK	Profile #0 is mapped on CID=1.
AT+UPSD=0,0,3	OK	Set the PDP type to IPv4v6 with IPv6 preferred for internal sockets.
AT+UPSDA=0,3	+CME ERROR: IP type configuration mismatch	Return an error result code because is detected a mismatch among the IPv4 assigned by the network and the preference for using an IPv6 in internal sockets.
AT+UPSD=0,0,0	OK	Set the PDP type to IPv4 referring the output of the +CGDONT read command.
AT+UPSDA=0,3	OK	Activate the PSD profile #0: the IPv4 address is already assigned by the network.
	+UUPSDA: 0,"100.108.232.233"	URC indicating that the PSD profile #0 has been successfully activated and the IPv4 assigned to the activated PDP context.
<b>The network assigns IPv6 address only</b>		
AT+CGDCONT=1,"IPV4V6","apn_name"	OK	Define the PDP context 1 with PDP type "IPV4V6" and APN "apn_name".
AT+CGACT=1,1	OK	PDP context 1 activation: only IPv6 address assigned by the network.
AT+CGDCONT?	+CGDCONT: 8,"IP","apn_name", 38.0.16.3.177.33.116.198.0.0. 0.3.107.232.191.1",0,0,0,0,0, 0 OK	Return IPv6 address.
AT+UPSD=0,100,1	OK	Profile #0 is mapped on CID=1.
AT+UPSD=0,0,2	OK	Set the PDP type to IPv4v6 with IPv4 preferred for internal sockets.
AT+UPSDA=0,3	+CME ERROR: IP type configuration mismatch	Return an error result code because is detected a mismatch among the IPv6 assigned by the network and the preference for using an IPv4 in internal sockets.
AT+UPSD=0,0,1	OK	Set the PDP type to IPv6 referring the output of the +CGDONT read command.
AT+UPSDA=0,3	OK	Activate the PSD profile #0: the IPv6 address is already assigned by the network.
	+UUPSDA: 0,"38.0.16.3.177.33. 116.198.0.0.0.3.107.232.191.1 "	URC indicating that the PSD profile #0 has been successfully activated and the IPv6 assigned to the activated PDP context.

### 5.5.1 PDP context activation by means of +UPSDA, impact of <PDP\_type> on address

#### TOBY-L2

Command	Response	Description
AT+UPSD=0,1,"apn_name"	OK	Set up the APN for the PSD profile #0.
AT+UPSD=0,0,3	OK	Set the PDP type to IPv4v6 with IPv6 preferred for internal sockets.
AT+UPSDA=0,3	+CME ERROR: APN configuration mismatch	Return an error result code because in detected a mismatch: in fact the network assigns only the IPv4, while the preference is for using IPv6 in internal sockets.

Command	Response	Description
AT+UPSD=0,0,0	OK	Change the PDP type to IPv4.
AT+UPSDA=0,3	OK	Activate the PSD profile #0: only IPv4 is assigned by the network.
	+UUPSDA: 0, "100.108.232.233"	URC indicating that the PSD profile #0 has been successfully activated and the IPv4 assigned to the activated PDP context.

## 5.6 Management of counters of sent and received PSD data

LEON-G1
LISA-U2
SARA-G3
SARA-U2

 Not supported by SARA-G300 / SARA-G310 modules.

The +UGCNTRD AT command reads the number of bytes and packets sent and received, while the +UGCNTSET AT command is used to set the counter. The AT commands may be used as follows:

Command	Response	Description
AT+UDNSRN=0, "ftp.u-blox.com"	+UDNSRN: "195.34.89.241" OK	DNS resolution of the URL "ftp.u-blox.com".
AT+UPSD=0,1, "WEB.OMNITEL.IT"	OK	Set up the APN for the GPRS connection profile "0". APN "web.omnitel.it" is an example only. Use the APN operator.
AT+UPSDA=0,3	OK	Activate the GPRS connection.
AT+UPSND=0,0	+UPSND: 0,0, "109.115.166.132" OK	Check the assigned IP address. In this example the assigned dynamic IP address is requested.
AT+USOCR=6	+USOCR: 0 OK	TCP socket creation. Socket #0 is created. The information text response returns the created socket identifier (in this case #0). If a new socket is created (without closing the already existent), a new socket identifier will be returned.
AT+USOCO=0, "195.34.89.241", 444	OK  +UUSORD: 0,32	Connect socket #0 to port 444 of a remote host with IP address 195.34.89.241. In this example an echo server has been used. The socket is now ready for read / write data.
AT+UGCNTRD	+UGCNTRD: 4,124,116,124,116 OK	Read the counters for total sent and received bytes for the defined context. <ul style="list-style-type: none"> <li>The total number of sent bytes on UL is 124 (44 bytes of SYN plus 40 bytes of ACK for TCP three-way-handshake plus 40 bytes of ACK for the received data)</li> <li>The total number of received bytes is 116 (44 bytes of SYN-ACK for TCP three-way-handshake plus 72 bytes of received data)</li> </ul>
AT+USORD=0,1024	+USORD: 0,32, "u-blox AG TCP/UDP test service" OK	Read data. The data is returned between quotation marks.
AT+USOWR=0,10, "HELLOWORLD"	+USOWR: 0,10 OK	Write 10 data bytes data on socket #0. If the final result code is returned then the data is sent to lower level of protocol stack.

Command	Response	Description
AT+UGCNTRD	+UGCNTRD: 4,214,206,214,206 OK	Read the counters for total sent and received bytes for the defined context. <ul style="list-style-type: none"> <li>The total number of sent bytes on UL has increased of 90 bytes (50 bytes of sent data plus 40 bytes of ACK for the received data)</li> <li>The total number of received bytes has increased of 90 bytes (50 bytes of received data plus 40 bytes of ACK for the sent data)</li> </ul>
AT+UGCNTSET=4,0,0	OK	Set the counter for total sent/received bytes to 0 for the PDP context identified by <cid> 4.
AT+UGCNTRD	+UGCNTRD: 4,0,0,0,0 OK	Read the counters for total sent / received bytes for the defined context.

## 5.7 DoCoMo PS PUSH context manual activation

LISA-U2
SARA-U2

Supported only by LISA-U200-62S and SARA-U201-63B versions.



The connection will take place on the same COM port where it has been accepted.

Command	Response	Description
AT+CGAUTO=3	OK	Set the automatic acceptance of Packet Domain network requests in modem compatibility mode, i.e. controlled by the S0 command.
ATS0=0	OK	Disable the automatic answering.
AT+CRC=1	OK	Enables detailed ring indication for the incoming calls.
	+CRING: GPRS "PPP", "", "M-PPP-RELAY", "<apn_name>"	The PS PUSH has been received. The URC shows the PDP type, the PDP address the requested L2P protocol and the APN of the incoming "Request PDP Context Activation". <ul style="list-style-type: none"> <li> If PDP_type = "PPP" then the PDP_addr will be empty and the L2P protocol required will be the PPP relay (M-PPP-RELAY).</li> <li> If PDP_type = "IP" then the PDP_addr will be shown and the P2P protocol will be empty.</li> </ul>
ATA	OK	Accept the incoming call.
or	CONNECT	The module will automatically activate the P2P protocol after the CONNECT result code:
AT+CGANS=1	OK	<ul style="list-style-type: none"> <li> If PDP_type = "PPP" then M-PPP-RELAY will be used.</li> <li> If PDP_type = "IP" then the PPP will be used.</li> </ul>
	CONNECT	

## 5.8 DoCoMo PS PUSH context manual reject

LISA-U2
SARA-U2

Supported only by LISA-U200-62S and SARA-U201-63B versions.

Command	Response	Description
AT+CGAUTO=3	OK	Set the automatic acceptance of Packet Domain network requests in modem compatibility mode, i.e. controlled by the S0 command.
ATS0=0	OK	Disable the automatic answering.
AT+CRC=1	OK	Enables detailed ring indication for the incoming calls.
	+CRING: GPRS "PPP", "", "M-PPP-RELAY", "<apn_name>"	The PS PUSH has been received. The URC shows the PDP type, the PDP address the requested L2P protocol and the APN of the incoming "Request PDP Context Activation". <ul style="list-style-type: none"> <li> If PDP_type = "PPP" then the PDP_addr will be empty and the L2P protocol required will be the PPP relay (M-PPP-RELAY).</li> <li> If PDP_type = "IP" then the PDP_addr will be shown and the P2P protocol will be empty.</li> </ul>
ATH	OK	Reject the incoming call and send a "PDP Context Activation Request Reject"
or		
AT+CGANS=0	OK	

## 5.9 Data connection management

TOBY-L2
TOBY-R2
LARA-R2

LTE is an IP based protocol. It may use the default bearer for signaling messages related to IMS service.

The basic network policy defines that the data connection is available either through the initial default bearer or through a user defined PDP context. The initial default bearer is activated during the attach procedure and it is initiated by the network as a response to the initial connectivity request message from the UE. In the case the network is not providing IP connectivity through the default bearer, an APN should be associated to the default bearer to overcome this limitation. Furthermore, several 4G network operators allow that every APN is associated only to one EPS bearer. There is no general rule about the presented issues, therefore some considerations are provided in the following sessions.

If the combined EPS/IMSI attach fails, according to the particular EPS mode set, the ME could perform a CSFB and change RAT, according to the particular mode of operation set. The +CEMODE AT command should be used accordingly to allow or avoid such a situation (AT+CEMODE=3).

## 5.9.1 Network policy: no IP connectivity on the default bearer

### TOBY-L2

The initial default bearer remains established throughout the lifetime of the PDN connection (since LTE is IP based) and it can be identified easily since it is automatically initiated by the DTE on CID 4. It is advised to not use the CID 4 for setting user-defined PDP context.

Command	Response	Description
AT+UUSBCONF=3, "RNDIS", 0	OK	Set the USB configuration to "High throughput".
AT+CFUN=1	OK	Set the module to full functionality.
AT+CPIN?	+CPIN: READY OK	Check the PIN status and act accordingly.
AT+COPS?	+COPS: 0,0,"I TIM",7 OK	Check the +COPS <Act> and act accordingly: <ul style="list-style-type: none"> <li>If &lt;Act&gt; = 7 (LTE) then no further action is needed</li> </ul> Else activate the context with +CGACT.
		Check the IP connectivity: <ul style="list-style-type: none"> <li>If the IP connectivity is provided no further actions are needed.</li> </ul>
AT+CFUN=4	OK	Set the module in the airplane mode to de-register from network
AT+UCGDFLT=1, "IP", "ibox.tim.it"	OK	Set the APN for the default bearer.
AT+CFUN=1	OK	Set the module to full functionality to register again on the network.
AT+CGACT?	+CGACT: 4,1 OK	Only the default initial bearer is active.
		Check the IP connectivity.

### TOBY-R2

### LARA-R2

The initial default bearer remains established throughout the lifetime of the PDN connection (since LTE is IP based) and it can be identified easily since it is automatically initiated by the DTE on CID 1. It is advised to not use the CID 1 for setting user-defined PDP context.

Command	Response	Description
AT+CFUN=1	OK	Set the module to full functionality.
AT+CPIN?	+CPIN: READY OK	Check the PIN status and act accordingly.
AT+COPS?	+COPS: 0,0,"I TIM",7 OK	Check the +COPS <Act> and act accordingly: <ul style="list-style-type: none"> <li>If &lt;Act&gt; = 7 (LTE) then no further action is needed</li> </ul> Else activate the context with +CGACT.
		Check the IP connectivity: <ul style="list-style-type: none"> <li>If the IP connectivity is provided no further actions are needed</li> </ul>
AT+COPS=2	OK	De-register the module.
AT+CGDCONT=1, "IP", "ibox.tim.it"	OK	Set the APN for the default bearer.
AT+COPS=0	OK	Register the module.
AT+CGACT?	+CGACT: 1,1 OK	Only the default initial bearer is active.
		Check the IP connectivity.



## 5.9.2 Network policy: only one bearer for each APN can be activated

### TOBY-L2

Command	Response	Description
AT+UUSBCONF=3,"RNDIS",0	OK	Set the USB configuration to "High throughput".
AT+CFUN=4	OK	Set the module in airplane mode to de-register from the network.
AT+CGDCONT=1,"IP","ibox.tim.it"	OK	Define a context accordingly.
AT+UCGDFLT=1,"IP","ibox.tim.it"	OK	Set the APN for the default bearer.
AT+CFUN=1	OK	Set the module to full functionality to register again on the network.
AT+CPIN?	+CPIN: READY OK	Check the PIN status and act accordingly.
AT+COPS?	+COPS: 0,0,"I TIM",7 OK	Check the +COPS <Act> and act accordingly: <ul style="list-style-type: none"> <li>If &lt;Act&gt; = 7 (LTE) then no further action is needed</li> </ul> Else activate the context with +CGACT.
AT+CGACT=1,1	+CME ERROR: Unknown error	Tentative to activate the PDP context on CID 1 is failed. The APN is associated to the default bearer, which is already active.
AT+CGACT?	+CGACT: 1,0 +CGACT: 4,1 OK	Only the default initial bearer is active.
AT+CGDCONT=1,"IP","wap.tim.it"	OK	Set another APN to CID 1.
AT+CGACT=1,1	OK	The second bearer can be activated, since a different APN is used.

### TOBY-R2

### LARA-R2

Command	Response	Description
AT+COPS=2	OK	De-register the module.
AT+CGDCONT=1,"IP","ibox.tim.it"	OK	Set the APN for the default bearer.
AT+CGDCONT=2,"IP","ibox.tim.it"	OK	Define another PDP context accordingly.
AT+COPS=0	OK	Register the module.
AT+CPIN?	+CPIN: READY OK	Check the PIN status and act accordingly.
AT+COPS?	+COPS: 0,0,"I TIM",7 OK	Check the +COPS <Act> and act accordingly: <ul style="list-style-type: none"> <li>If &lt;Act&gt; = 7 (LTE) then no further action is needed</li> </ul> Else activate the context with +CGACT.
AT+CGACT=1,2	+CME ERROR: Unspecified GPRS error	Tentative to activate the PDP context on CID 2 is failed. The APN is associated to the default bearer, which is already active.
AT+CGACT?	+CGACT: 1,1 +CGACT: 2,0 OK	Only the default initial bearer is active.
AT+CGDCONT=2,"IP","wap.tim.it"	OK	Set another APN to CID 2.
AT+CGACT=1,2	OK	The second bearer can be activated, since a different APN is used.

### 5.9.3 Network policy: more than one bearer with the same APN can be activated

**TOBY-L2**

Command	Response	Description
AT+UUSBCONF=3, "RNDIS", 0	OK	Set the USB configuration to "High throughput" and disable the audio over USB.
AT+CFUN=4	OK	Set the module in airplane mode to de-register from the network.
AT+CGDCONT=1, "IP", "web.omnitel.it"	OK	Define a context accordingly.
AT+UCGDFLT=1, "IP", "web.omnitel.it"	OK	Set the APN for data connection for the default bearer.
AT+CFUN=1	OK	Set the module to full functionality to register again on network.
AT+CPIN?	+CPIN: READY OK	Check the PIN status and act accordingly.
AT+COPS?	+COPS: 0,0,"vodafone IT",7 OK	Check the +COPS <Act> and act accordingly: <ul style="list-style-type: none"> <li>If &lt;Act&gt; = 7 (LTE) then no further action is needed</li> </ul> Else activate the context with +CGACT.
AT+CGACT=1,1	OK	PDP context on CID 1 activated successfully.
AT+CGACT?	+CGACT: 1,1 +CGACT: 4,1 OK	

**TOBY-R2**
**LARA-R2**

Command	Response	Description
AT+COPS=2	OK	De-register the module.
AT+CGDCONT=1, "IP", "web.omnitel.it "	OK	Set the APN for the default bearer.
AT+CGDCONT=2, "IP", "web.omnitel.it"	OK	Define another PDP context accordingly.
AT+COPS=0	OK	Register the module.
AT+CPIN?	+CPIN: READY OK	Check the PIN status and act accordingly.
AT+COPS?	+COPS: 0,0,"vodafone IT",7 OK	Check the +COPS <Act> and act accordingly: <ul style="list-style-type: none"> <li>If &lt;Act&gt; = 7 (LTE) then no further action is needed</li> </ul> Else activate the context with +CGACT.
AT+CGACT=1,2	OK	PDP context on CID 2 activated successfully.
AT+CGACT?	+CGACT: 1,1 +CGACT: 2,1 OK	

**TOBY-L2**
**TOBY-R2**
**LARA-R2**

In the case of handover from LTE to 3G/2G, most of the networks will also keep the initial default bearer active in 3G.

In the case of handover from 3G/2G to LTE, the PDP contexts activated in 3G will also be kept active in LTE.

Figure 4 shows the flow chart with the suggested operations and actions for an LTE PS registration from the DTE point of view.

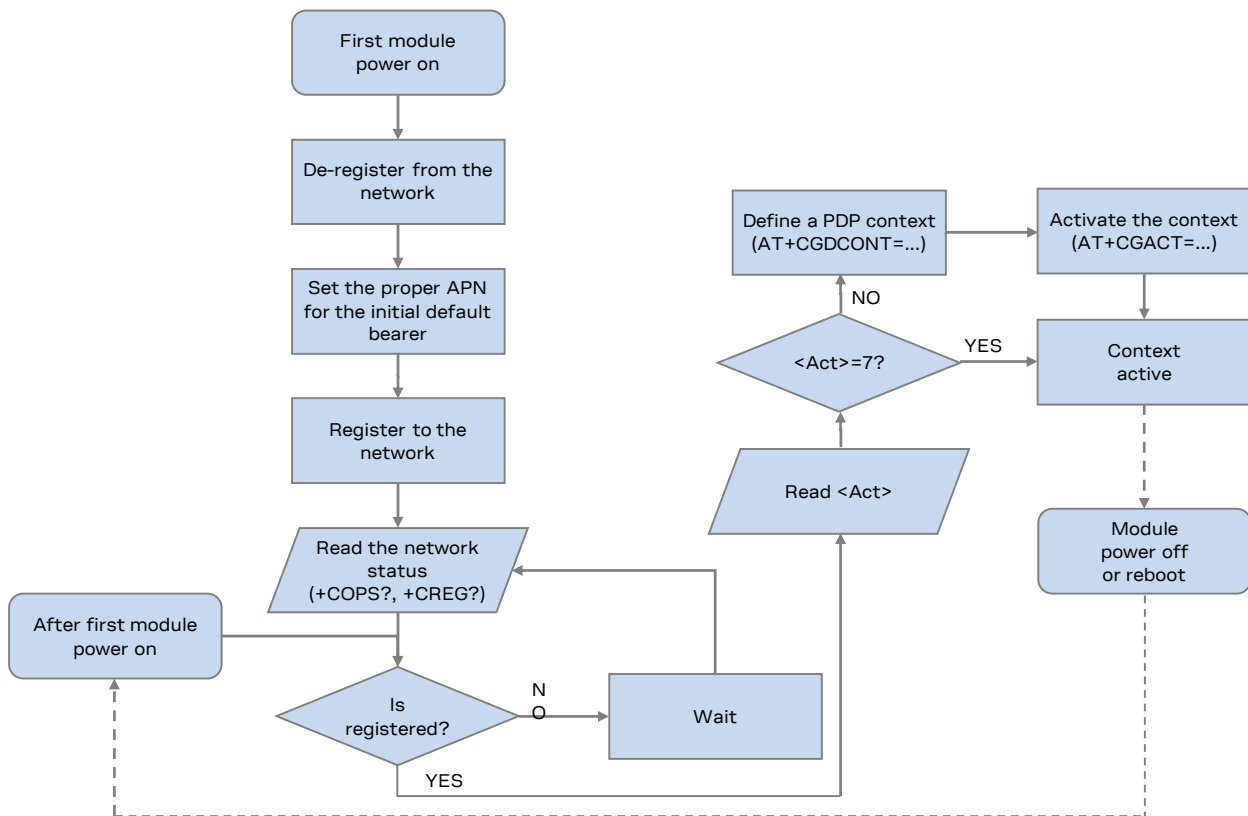

Figure 4: Data connection activation flow chart for TOBY-L2

Set the initial default bearer the proper AT command before a LTE network registration.

Once the network registration is successful, the DTE must check the RAT:

- 3G/2G case: the PDP context must be defined and activated (+CGDCONT and +CGACT)
- LTE case: according to the network policies, the user must use the initial default bearer or, if allowed, may define a PDP context



### 5.10.3 Set up the connection on Windows 7

Command	Response	Description
AT+CFUN=4	OK	Set the module in airplane mode.
AT+CGDCONT=1,"IP","ibox.tim.it"	OK	Define a PDP context with the needed APN.
AT+UCGDFLT=1,"IP","ibox.tim.it"	OK	Define the initial PDP context with the needed APN. This will be activated only if the module registers to an LTE network.
AT+CFUN=1	OK	Set the module to full functionality.
AT+CPIN?	+CPIN: READY OK	Check the PIN status and act accordingly.
AT+COPS?	+COPS: 0,0,"I TIM",7 OK	Check the +COPS <Act> and act accordingly: <ul style="list-style-type: none"> <li>If &lt;Act&gt; = 7 (LTE) then no further action is needed</li> </ul> Else activate the context with +CGACT.
AT+CGCONTRDP	+CGCONTRDP: 4,5,"ibox.tim.it.mnc001.mcc222.gprs", "5.168.209.178.255.255.255.255", "5.168.209.178", "10.207.43.46", "10.206.56.132", "0.0.0.0", "0.0.0.0",0 OK	Read the IP address (5.168.209.178) and the primary DNS address (10.207.43.46) of the EPS bearer.

Windows can be configured using the command shell or the graphical UI. The graphical UI method is described as follows.

Open "Network and Sharing Center" and click on "Local Area Connection 3" (associated to RNDIS interface):

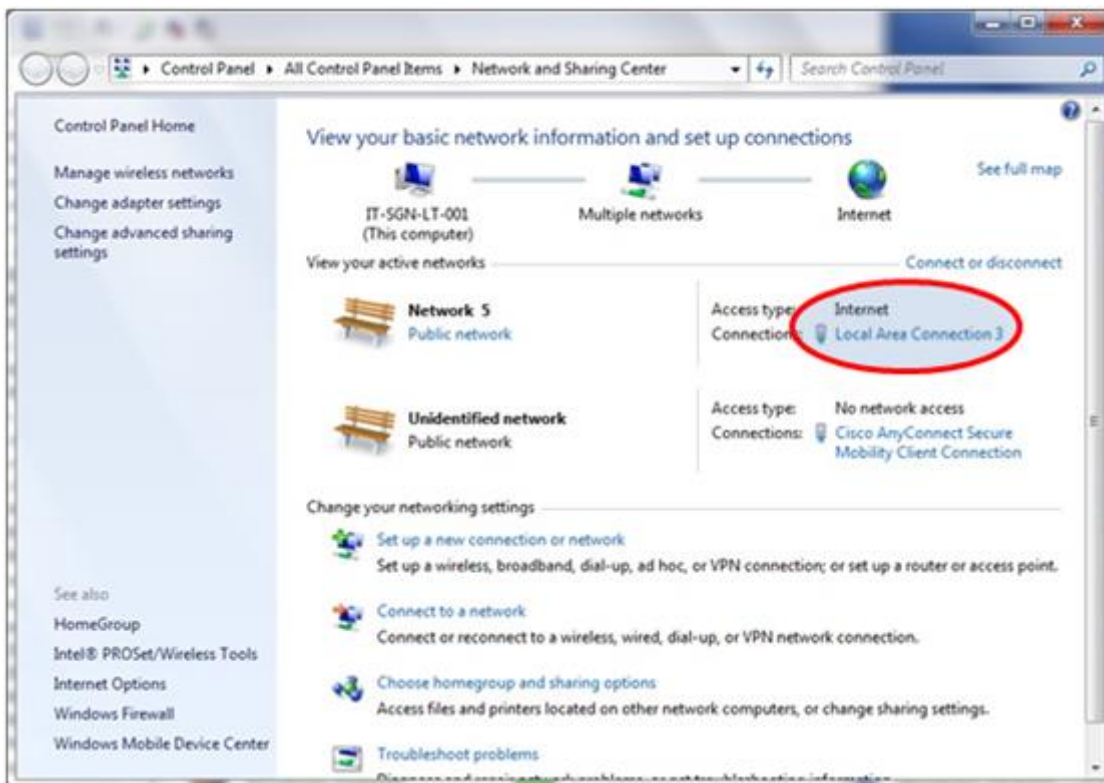

Figure 5: Windows 7 Control Panel

Click on "Properties":

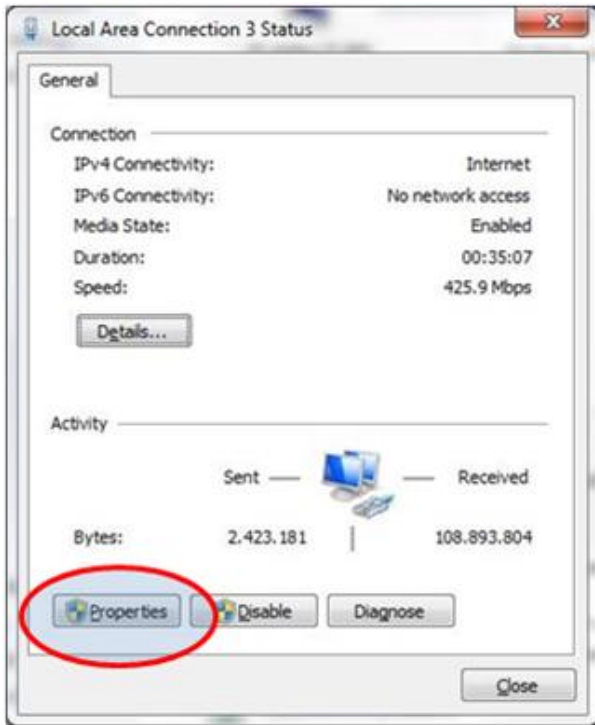

Figure 6: Local Area Connection status

Search "Internet Protocol Version 4 (TCP/IPv4)" and click on "Properties":

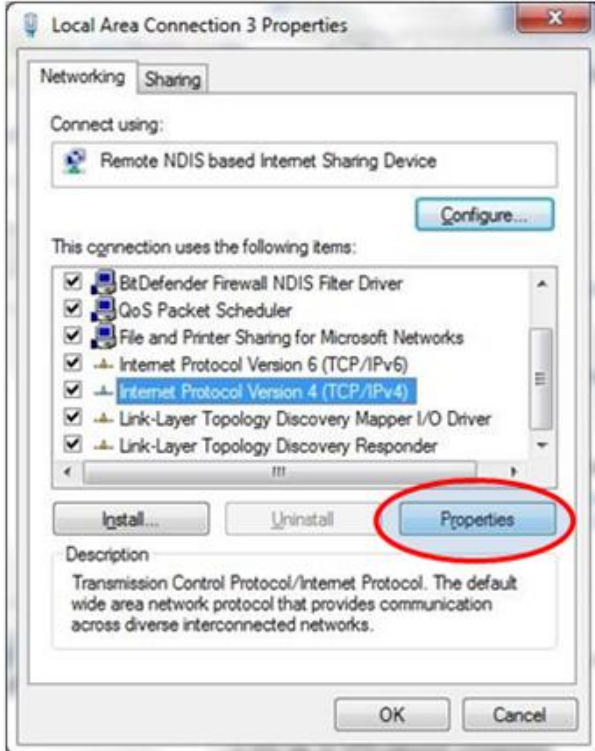

Figure 7: Local Area Connection 3 properties

Check the "Obtain an IP address automatically" and "Obtain DNS server address automatically" option. This enables the DHCP client on the RNDIS interface.

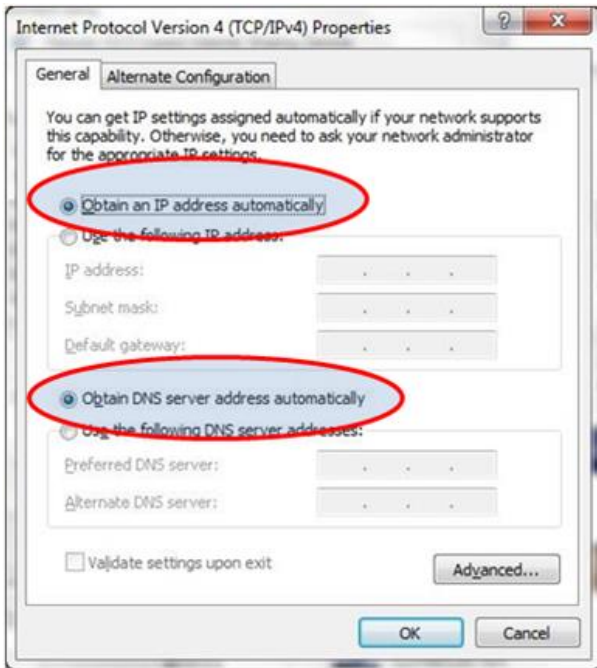

Figure 8: Internet protocol Version 4 properties

If it is not possible to access the Internet, then manually set the DNS server address. For example, use the DNS server provided by the cellular network (83.224.70.94 or 10.207.43.46), or Google DNS servers (8.8.8.8 or 8.8.4.4):

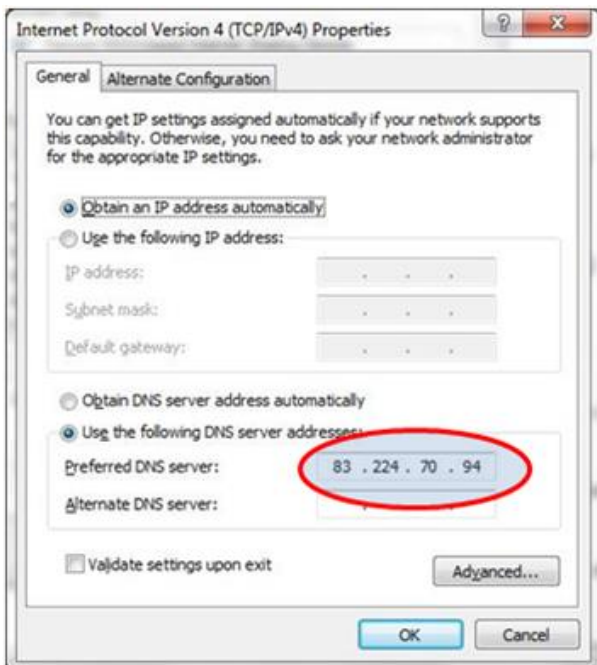

Figure 9: Set the preferred DNS

## 5.11 Network connectivity (BRIDGE mode)

### 5.11.1 2G/3G case

Command	Response	Description
AT+CFUN=4	OK	Set the module in airplane mode.
AT+UBMCONF=2	OK	Set the BRIDGE mode configuration.
AT+CFUN=1	OK	Set the module to full functionality.
AT+COPS?	+COPS: 0,0,"vodafone IT",2 OK	Check the cellular network registration status.
AT+CGDCONT=1,"IP","web.omnitel.it"	OK	Define a PDP context with the needed APN.
AT+CGACT=1,1	OK	Activate the PDP context.
AT+CGDCONT?	+CGDCONT: 1,"IP","web.omnitel.it",2.43.2.44,0,0,0,0,0,0 OK	Read the IP address: 2.43.2.44.
AT+UIPADDR=1	+UIPADDR: 1,"usb0:0",2.43.2.211,"255.255.255.255","", OK	Read the USB IP configuration and the IPv4 address of the interface: 2.43.2.211. This address should be used as gateway.
AT+CGCONTRDP=1	+CGCONTRDP: 1,0,"web.omnitel.it",2.43.2.44.255.255.255.255,2.43.2.44,"10.133.13.210",83.224.65.106,"0.0.0.0",0 OK	Read the IP address (2.43.2.44) and the primary DNS address (10.133.17.210) of the EPS bearer.

### 5.11.2 4G case

Command	Response	Description
AT+CFUN=4	OK	Set the module in airplane mode.
AT+UBMCONF=2	OK	Set the BRIDGE mode configuration
AT+CFUN=1	OK	Set the module to full functionality.
AT+COPS?	+COPS: 0,0,"I TIM",7 OK	Check the cellular network registration status.
AT+CGACT?	+CGACT:1,4 OK	
AT+UIPADDR=4	+UIPADDR: 4,"usb0:3",2.197.17.206,"255.255.255.255","", OK	Read the USB IP configuration and the IPv4 address of the interface: 2.197.17.206. This address should be used as gateway.
AT+CGCONTRDP	+CGCONTRDP: 4,5,"ibox.tim.it.mnc001.mcc222.gprs",2.197.17.49.255.255.255.255,2.197.17.49,"10.207.43.46",10.206.56.132,"0.0.0.0",0 OK	Read the IP address (2.197.17.49) and the primary DNS address (10.207.43.46) of the EPS bearer.

### 5.11.3 Set up the connection on Windows 7

Windows can be configured using the command shell or the UI. This document describes only the UI method.

The configuration is split into two phases:

- Basic configuration: allows internet browsing, which is the advised configuration for most users
- Debug configuration: allows communication with the TOBY-L2 module, advised for debug sessions.



### 5.11.3.1 Basic configuration

Using this configuration it is possible to access the Internet.

Open "Network and Sharing Center" and click on "Local Area Connection 3" (associated to RNDIS interface):

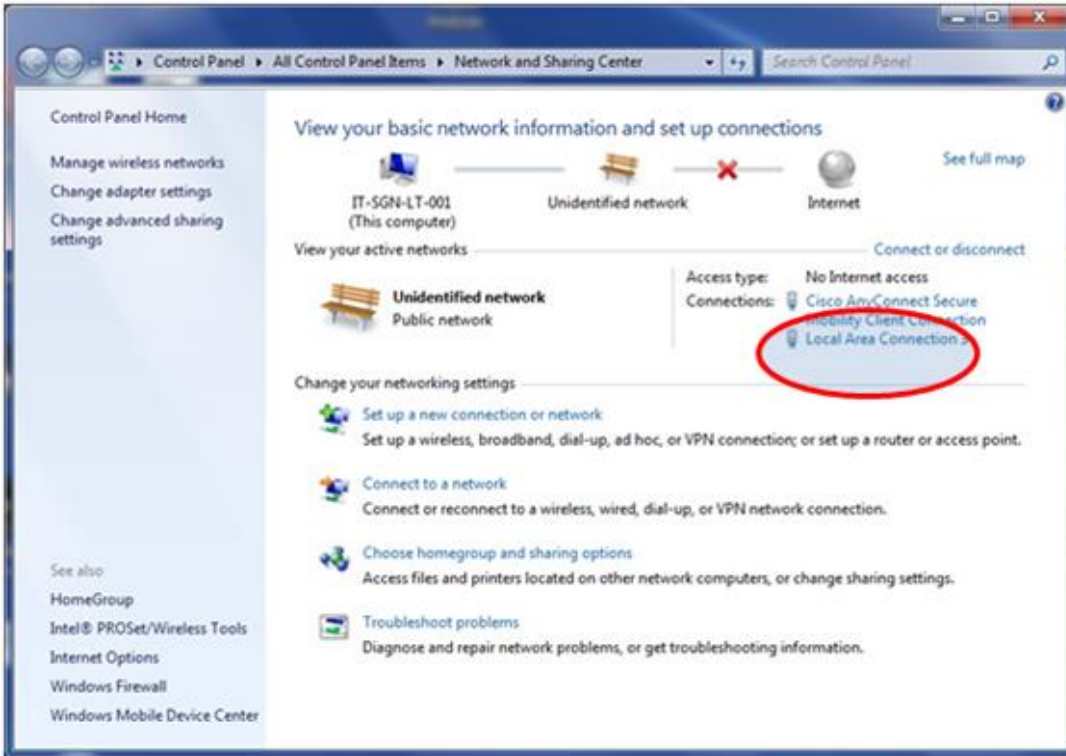

Figure 10: Windows 7 Control Panel

Click on "Properties":

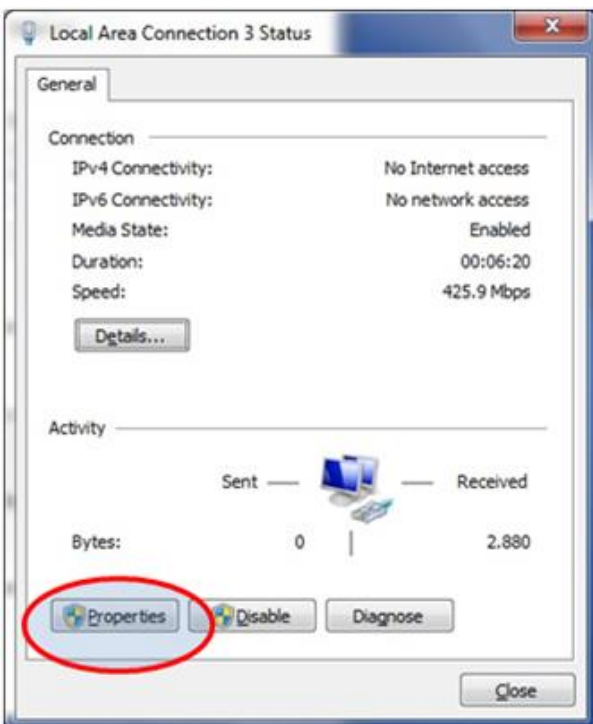

Figure 11: Local Area Connection status

Search "Internet Protocol Version 4 (TCP/IPv4)" and click on "Properties":

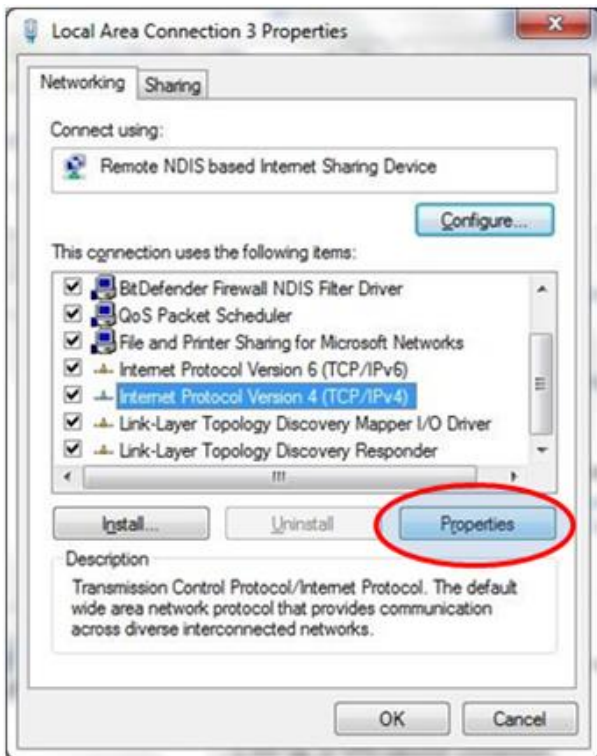

Figure 12: Local Area Connection properties

Check the option "Use the following IP address" and "Use the following DNS server addresses". Set the IP address provided by network (+CGCONTRDP), and the network mask 255.255.255.255. Set the DNS server address returned by network (+CGCONTRDP) or, for example, the Google public DNS server (8.8.8.8). Click on "OK" to apply all settings.

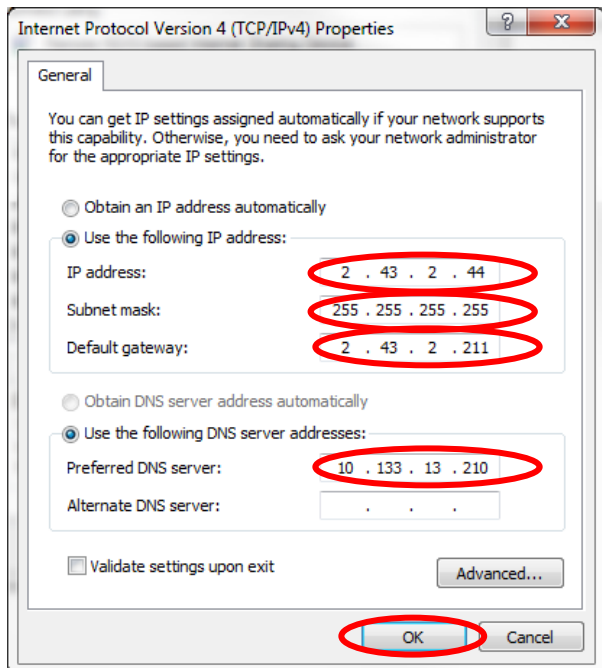
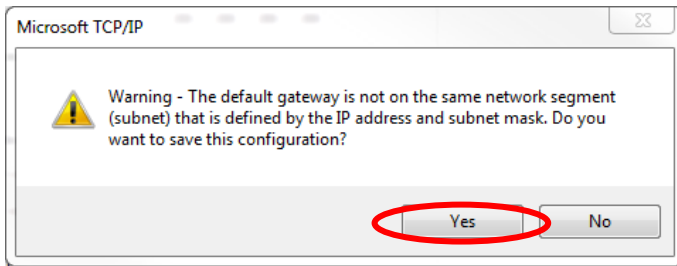

Figure 13: Internet protocol Version 4 properties

If a window pops up with the following warning, ignore it and click "Yes".

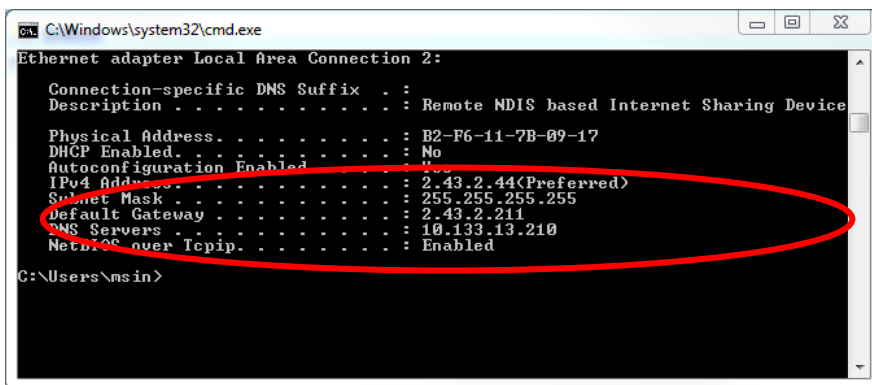

**Figure 14: Warning error during IP configuration**

Now it is possible to access the Internet.

Depending on the system configuration, Windows could add some auto generated IP addresses that will cause mismatches in the routing table. It is now shown how to verify that the appropriate configuration has been applied.

Open a DOS shell and check the IP configuration via the "ipconfig /all" command as shown below:



**Figure 15: Shell IP Configuration**

Verify that the IP address has been applied correctly to the RNDIS interface.

If there are any IP addresses not related to the current procedure, remove them using the DOS shell (see TOBY-L2 series Networking Modes Application Note [\[12\]](#) for more details).

Check the routing table via the "route print" command as shown below:

```

C:\Windows\system32>route print
=====
Interface List
19...b2 f6 11 7b 09 17 .....Remote NDIS based Internet Sharing Device
1.....Software Loopback Interface 1
=====

IPv4 Route Table
=====
Active Routes:
Network Destination        Netmask          Gateway          Interface        Metric
0.0.0.0                    0.0.0.0          2.43.2.211      2.43.2.44        266
2.43.2.44                  255.255.255.255  On-link        2.43.2.44        266
127.0.0.0                  255.0.0.0        On-link        127.0.0.1        306
127.0.0.1                  255.255.255.255  On-link        127.0.0.1        306
127.255.255.255           255.255.255.255  On-link        127.0.0.1        306
224.0.0.0                  240.0.0.0        On-link        127.0.0.1        306
224.0.0.0                  240.0.0.0        On-link        2.43.2.44        266
255.255.255.255           255.255.255.255  On-link        127.0.0.1        306
255.255.255.255           255.255.255.255  On-link        2.43.2.44        266
=====

Persistent Routes:
Network Address            Netmask          Gateway Address  Metric
0.0.0.0                    0.0.0.0          2.43.2.211      Default
=====

IPv6 Route Table
=====
Active Routes:
If Metric Network Destination      Gateway
1 306 ::1/128 On-link
1 306 ff00::/8 On-link
=====

Persistent Routes:
None
C:\Windows\system32>
    
```

Figure 16: Routing table

Verify that the routing table has been created correctly as shown on the figure.

### 5.11.3.2 Debug configuration

This section describes how to configure the RNDIS settings for debugging purposes. The previous configuration must be set before proceeding.

Open the "Internet protocol Version 4 properties" as described above and click "Advanced".

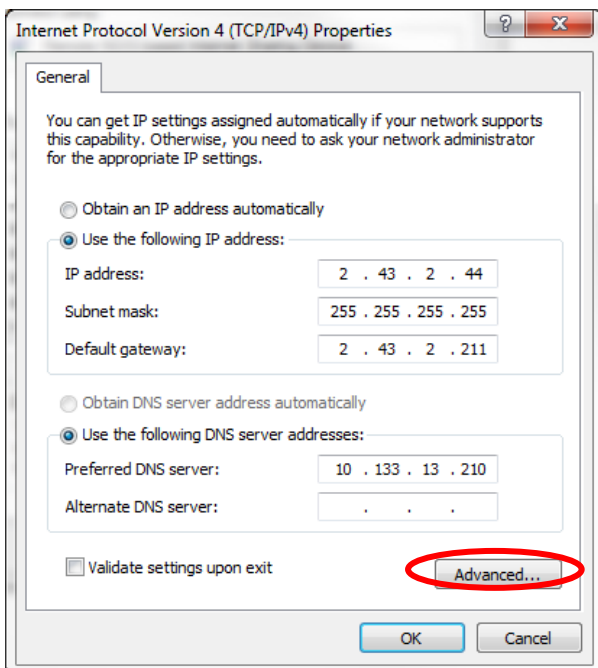

Figure 17: Internet protocol Version 4 properties

Click on "Add" to add an 'alias'.

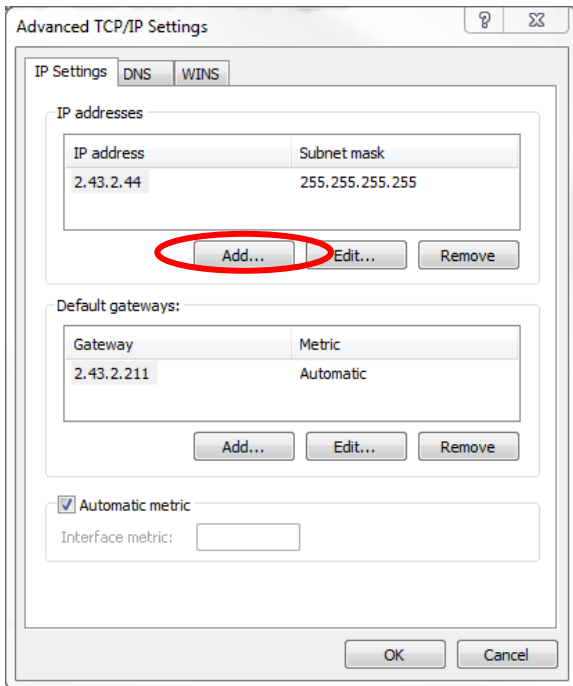

Figure 18: Advanced TCP/IP settings

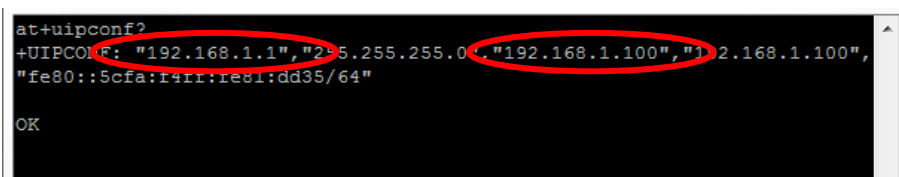

Figure 19 +UIPCONF AT command output

In the new window, insert the IP address returned by +UIPCONF AT command (third IP address in the [Figure 19](#)), set the subnet mask to "255.255.255.0" and press "Add".

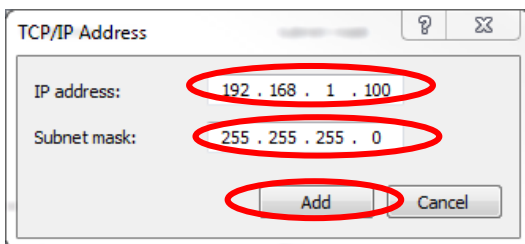

Figure 20: TCP/IP address

Click "OK" in the previous windows to apply the configuration.

It is now possible to ping the module with the command "ping 192.168.1.1", where "192.168.1.1" is the IP address of the module (first IP address in the [Figure 19](#)).

To verify that the appropriate configuration has been applied, open a DOS shell and check the IP configuration via the "ipconfig /all" command, as shown below:

```

C:\Windows\system32\cmd.exe

Ethernet adapter Local Area Connection 2:

Connection-specific DNS Suffix . . . : 
Description . . . . . : Remote NDIS based Internet Sharing Device

Physical Address. . . . . : B2-F6-11-7B-09-17
DHCP Enabled. . . . . : No
Autoconfiguration Enabled . . . . : Yes
IPv4 Address. . . . . : 2.43.2.44(Preferred)
Subnet Mask . . . . . : 255.255.255.255
IPv4 Address. . . . . : 192.168.1.100(Preferred)
Subnet Mask . . . . . : 255.255.255.0
Default Gateway . . . . . : 2.43.2.211
DNS Servers . . . . . : 10.133.13.210
NetBIOS over Tcpip. . . . . : Enabled

C:\Users\msin>
    
```

Figure 21: TCP/IP address

Verify that the new IP alias has been set correctly.

Check the routing table via the "route print" command as shown below:

```

C:\Windows\system32\cmd.exe

Microsoft Windows [Version 6.1.7601]
Copyright (c) 2009 Microsoft Corporation. All rights reserved.

C:\Users\msin>route print

=====
Interface List
19...b2 f6 11 7b 09 17 .....Remote NDIS based Internet Sharing Device
1.....Software Loopback Interface 1
=====

IPv4 Route Table
=====
Active Routes:
Network Destination        Netmask          Gateway          Interface        Metric
0.0.0.0                    0.0.0.0          2.43.2.211      2.43.2.44        266
2.43.2.44                  255.255.255.255  On-link         2.43.2.44        266
127.0.0.0                  255.0.0.0        On-link         127.0.0.1        306
127.0.0.1                  255.255.255.255  On-link         127.0.0.1        306
127.255.255.255           255.255.255.255  On-link         127.0.0.1        306
192.168.1.0                255.255.255.0    On-link         2.43.2.44        266
192.168.1.100             255.255.255.0    On-link         2.43.2.44        266
192.168.1.255             255.255.255.255  On-link         2.43.2.44        266
224.0.0.0                  240.0.0.0        On-link         127.0.0.1        306
224.0.0.0                  240.0.0.0        On-link         2.43.2.44        266
255.255.255.255           255.255.255.255  On-link         127.0.0.1        306
255.255.255.255           255.255.255.255  On-link         2.43.2.44        266

Persistent Routes:
Network Address            Netmask          Gateway Address  Metric
0.0.0.0                    0.0.0.0          2.43.2.211      Default

IPv6 Route Table
=====
Active Routes:
If Metric Network Destination      Gateway
1 306 ::1/128 On-link
1 306 ff00::/8 On-link

Persistent Routes:
None
    
```

Figure 22: Routing table

Verify that the routing has been set correctly, as shown on the figure.

### 5.11.3.3 Restore previous windows configuration

To stop the data connectivity, delete all the aliases added to the RNDIS interface:

- remove the alias from "Advanced TCP/IP Settings":
  - in the provided example remove the alias associated to address "192.168.1.100"
- check the option "Obtain an IP address automatically" and "Obtain DNS server address automatically" option

## 5.12 Dial-up

### TOBY-L2

The module is able to perform dial-up connections supporting the Point-to-Point Protocol (PPP). The PPP connection is established between the target and the DTE in both router and bridge modes. In particular, the target performs as the PPP server, while the DTE performs as the PPP client.

### 5.12.1 Generic dial-up

#### TOBY-L2

Two scenarios should be considered. In 2G/3G network a PDP context should be defined to be used by the dial-up connection. For 4G networks there are several cases to be taken into account.

#### 5.12.1.1 2G/3G networks

Command	Response	Description
AT+CGDCONT=1,"IP",<apn>	OK	Define the PDP context on CID=1.
ATD*99***1#		Perform the dial-up on the PDP context on CID=1.

#### 5.12.1.2 4G networks

##### Dial-up on an initial default EPS bearer

This example considers the case in which the CID=4 is an Initial Default EPS bearer.

Command	Response	Description
AT+UUSBCONF?	+UUSBCONF: 0,"",,"0x1141" OK	Check that the module is in 'Fairly back-compatible' configuration, if not, set this mode (see the u-blox AT Commands Manual [1]).
AT+CFUN=4	OK	Set the module in airplane mode.
AT+UCGDFLT=1,"IP",<apn>,,,, ,,,,,,,,,,,,,1,<user>,<p pass>	OK	Configure the initial default EPS bearer for LTE network to ensure connectivity on it.
AT+UAUTHREQ=4,1,<user>,<p ass>	OK	Configure the authentication parameters for the default EPS bearer for LTE network (if needed).
AT+CFUN=1	OK	Sets the MT to full functionality.
ATD*99***4#		Perform the dial-up on the initial default EPS bearer.

 In this case the dial-up can be performed only in the in 'Fairly back-compatible' USB profile. Once the dial-up connection is terminated the EPS bearer at CID=4 is disconnected and it is locally undefined. The connectivity is no more available at CID=4.

##### Dial-up on a default EPS bearer

This example considers the case in which the CID=1 is not an initial default EPS bearer.

Command	Response	Description
AT+CGDCONT=1,"IP",<apn>	OK	Define the default EPS bearer on CID=1.
AT+UAUTHREQ=1,1,<user>,<p ass>	OK	Configure the authentication parameters for the default EPS bearer for LTE network (if needed).
ATD*99***1#		Perform the dial-up on the default EPS bearer on CID=1.

 In this case the dial-up can be performed in any USB profile.

## 5.12.2 Local dial-up

### TOBY-L2

u-blox cellular modules support the local dial-up connection. This feature allows modules to establish an IP-based connection with an external application processor through CDC-ACM, UART or MUX interfaces. During the local dial-up, a point to point connection is created between the module IP stack and the external application processor IP stack. To be noticed, the connectivity of the host depends on the connectivity provided to the module IP stack.

Command	Response	Description
ATD*99***100#		Perform the local dial-up.

## 5.13 Data context active after boot

### 5.13.1 TOBY-L2 pseudo code

#### TOBY-L2

The following pseudo-code can be used to have a data connection active on the module considering the RAT on which the module will first register.

 The following pseudo-code does not apply to TOBY-L201 in Verizon configuration.

1. Go into airplane mode (AT+CFUN=4)
2. Delete all previous defined context (+CGDEL)
3. Set the APN for the initial default bearer for 4G (+UCGDFLT) and authentication parameters if needed
4. Set the APN for the PDP context for 2G/3G on cid=1 with +CGDCONT and authentication parameters (+UAUTHREQ) if needed
5. Enable all useful URCs (+CREG/+CGREG/+CEREG/+CGEREP) to know the network registration status and the PDP context status
6. Go to full mode (AT+CFUN=1)
7. Wait for registration (check URC)
  - If (registered on 4G)
    - {
    - Nothing to do, context on cid=4 is already active
    - }
  - else if (registered on 2G or 3G)
    - {
    - Activate the context on cid=1 with AT+CGACT=1,1
    - }
  - else
    - {
    - Not registered, wait or check for any error
    - }

If the module registers first on 4G, the initial default bearer on cid=4 is active, if the module move later to 2G/3G the same context is still active (if not advised differently by URCs).

If the module registers first on 2G/3G, the PDP context is activated on cid=1 with +CGACT, if the module move later to 4G, this same context (cid=1) will be used for LTE registration (if not advised differently by URCs).



## 6 IP Multimedia Subsystem (IMS)

IMS is an architectural framework for delivering IP multimedia services.

The IMS client registration needs an active PDP context. The IMS registration status can be checked via +CIREG, while the IMS PDP context can be checked with the +CGDCONT read command or notified by +CGEV URCs enabled via the +CGEREP AT command.

Usually during the IMS PDN establishment all needed parameters are automatically configured by the network, retrieved from ISIM or derived from the USIM (i.e. P-CSCF address, username, password, etc). The user/application shall just set/check the related APN.

### 6.1 How to set IMS APN

**TOBY-L2**

Supported by TOBY-L201 series.

The IMS client can be configured with the +UIMSCONF AT command. In the following there is an example about the IMS APN configuration.

Command	Response	Description
AT+UIMSCONF="KEY_IMS_PDP_APN", "ims", 1	OK	Set the APN for IMS.
AT+UIMSCONF="KEY_IMS_PDP_TYPE", "IPV4V6", 1	OK	Set the preferred PDP type to IPv4IPv6.

**TOBY-R2**

**LARA-R2**

The IMS client can be configured with the +UIMSCFG AT command, by means of proper keys that configure the corresponding functionality.

Command	Response	Description
AT+UIMSCFG=0, 1, 51, "ims"	OK	Set the APN for IMS.
AT+UIMSCFG=0, 1, 53, 2	OK	Set the preferred PDP type to IPv4IPv6.

For testing on CMW500 callbox, the following optional SIP configuration is needed:

```
AT+UIMSCFG=0, 2, 256, 0, 257, 1
```

### 6.2 How to disable/enable IMS client

If the application or user do not need to use IMS services (i.e. SMS over IMS, VoLTE) then it is possible to turn off the IMS client.

**TOBY-L2**

Supported by TOBY-L201 series.

Command	Response	Description
AT+UIMSCONF="KEY_IMS_SUPPORT", "false"	OK	Disable the IMS client.
AT+UIMSCONF="KEY_IMS_SUPPORT", "true"	OK	Enable the IMS client.

**TOBY-R2**
**LARA-R2**

Command	Response	Description
AT+UIMSCFG=0,1,50,0	OK	Disable the IMS client auto-login.
AT+UIMSCFG=0,1,50,1	OK	Enable the IMS client auto-login.

## 6.3 IMS client registration

**TOBY-L2**
**TOBY-R2**
**LARA-R2**

The following table depicts the PDP contexts status once the IMS client is registered.

cid	TOBY-L2	TOBY-L201 (AT+UMNOCONF=3,15)	TOBY-R2	LARA-R204 (AT+UMNOCONF=3,7)
1			Initial default EPS bearer	Initial default EPS bearer for IMS
2				
3				
4	Initial default EPS bearer	Initial default EPS bearer for IMS		
....				
7				
8	Default bearer for IMS client	Default bearer for VZWINTERNET APN		
...				
31			Default bearer for IMS client	

In Verizon configuration the PDP context associated to the IMS client is the initial default bearer as per network operator requirements.

## 6.4 VoLTE call

**TOBY-R2**
**LARA-R2**

In order to start a VoLTE call the device shall be registered to IMS.

If VoLTE is not supported by the device or the network, and 2G or 3G are supported, voice calls will be redirected to legacy domains via CSFB (fallback from LTE to a legacy cellular technology).

From a user/application point of view the command to be used to start a voice call (both VoLTE or CSFB) is always the same: `ATD<number>;`

During a VoLTE call the network will force the activation of a secondary context, which is associated to the IMS primary context and provides connections to the same PDN but with different QoS. It has the same IP address of its associated primary context. Note that “secondary” does not mean the second context activated.

The following diagram depicts a VoLTE call from UE-1 to UE-2.

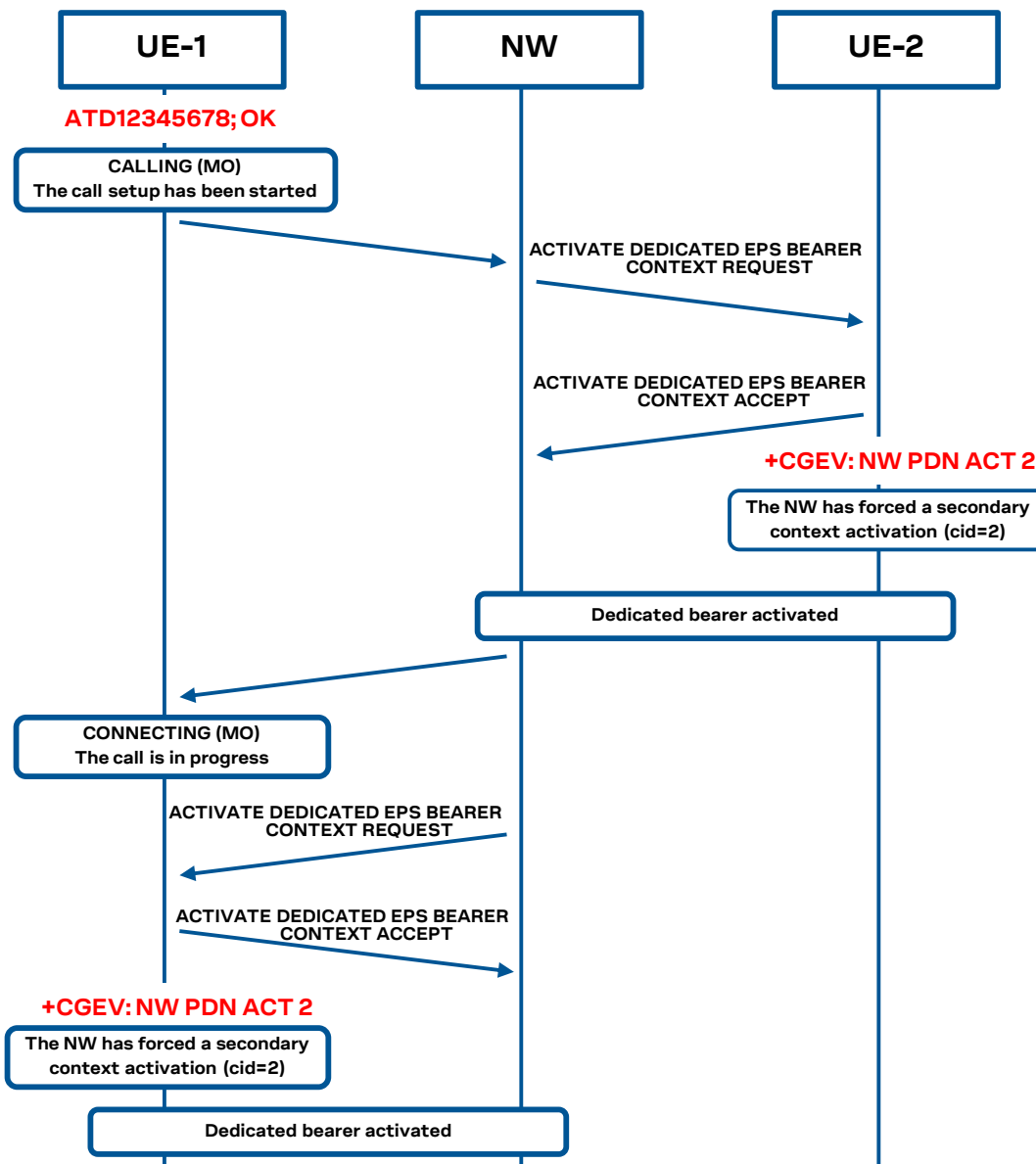

The following table depicts the PDP contexts status once the VoLTE call is active.

cid	LARA-R2 / TOBY-R2
1	Initial default EPS bearer
2	
3	
4	
....	
7	
8	
...	
31	Default bearer for IMS client
32	Dedicated bearer for VoLTE call (associated to cid=31)

The following commands can be used to set the APN and the URI for a VoLTE conference call.

**TOBY-R2**
**LARA-R2**

Command	Response	Description
AT+CGDCONT=1,"IPV4V6","mobile.vo dafone.it"	OK	Set the MNO APN.
AT+UIMSCFG=0,1,200,"mobile.vodaf one.it"	OK	Set the XCAP APN.
AT+UIMSCFG=0,1,9,"sip:mtel@conf -factory.ims.mnc002.mcc262.3gppn etwork.org"	OK	Set the VoLTE conference URI.
AT+UIMSCFG=0,1,253,1	OK	To make use of the SIP URI instead of TEL URI.
AT+UIMSCFG=0,1,269,0	OK	Disable subscription to VoLTE conference.
AT+UIMSCFG=0,1,269,1	OK	Enable subscription to VoLTE conference.
AT+CFUN=16	OK	Silent reset of the module.

## 7 Speech calls

TOBY-R2

LARA-R2

TOBY-L2

LISA-U2

SARA-G3

SARA-U2

### 7.1 Voice call monitoring

#### 7.1.1 Quality of the radio link

A network registration with a given MNO allows a UE to perform and receive voice calls. The quality of a voice call (either a legacy CS call or a VoLTE call over the PS network) strictly depends on the quality of the cellular channel.

The +CESQ and +CSQ AT commands are intended for the real-time evaluation of the signal strength and quality of the current cellular connection.

As can be seen by the related description in the u-blox AT Commands Manual [1], the meaning of the output of the +CSQ AT command depends on the current RAT. It is therefore recommended to either enable URCs that provide information about the current RAT or to poll the current registration status to have updated information about current RAT used by the UE and to correctly map the output of the +CSQ AT command. The suggestion is to rely on the following AT commands:

- +CREG CS network registration status (2G – 3G) information
- +CGREG GPRS network registration status (2G – 3G) information
- +CEREG EPS network registration status (4G) information
- +UREG PS radio capabilities information

#### 7.1.2 Status of the calls

The list of the current calls, along with the respective status, can be monitored through the +CLCC AT command.

This command is particularly useful when managing multiparty calls and e.g. to check the state of an incoming call indicated by the RING URC before entering ATA, since the call might have been released by the caller in the meantime.

Moreover, the +UCALLSTAT AT command enables the related URC, issued each time a call status change occurs (one URC for each call). If a SRVCC procedure is performed, the +UCALLSTAT URC will show a temporary call disconnection.

The information about the speech codec used for voice calls in legacy mode can be displayed through the +USPEECHINFO AT command, that enables also the related URC at each change in the used codec.

Call setup and call clearing events can be monitored via +CEER command.

The following example shows the suggested operations and actions for an application monitoring the status and quality of a voice call:

Command	Response	Description
AT+CREG=1	OK	Enable network registration URC.
AT+UCALLSTAT=1	OK	Enable call reporting URC.
ATD8496	OK	Call the destination with number "8496".
	+UCALLSTAT: 1, 2	Call dialing.
	+UCALLSTAT: 1, 4	Call ringing.
	+UCALLSTAT: 1, 7	Call active.

Command	Response	Description
AT+CLCC?	+CLCC: 1,0,0,0,0,"8496",129," ",4 OK	1 call is active, MO call, to number 8496.
AT+CREG?	+CREG: 2,1,"3987","01EB7F01", 2 OK	The ME is in registered with the home PLMN, LAC: "3987", CI "01EB7F01", UTRAN RAT.
AT+CSQ	+CSQ: 19,1 OK	Given that the ME is in UTRAN RAT, RSCP is 19, mean Bit Error Probability (BEP) per radio block in the range [24-27].
AT+CESQ	+CESQ: 99,99,32,29,255,255 OK	Given that the current serving cell is a UTRA FDD cell, <rxlev>,<ber>,<rsrq> and <rsrp> are set as "not detectable". Instead, the value <rsrp> is 32 (-89dBm) and <ecn0> is 29 (-10 dBm).
AT+CREG?	+CREG: 2,1,"3987","01EB7F01", 0 OK	The ME is in registered with the home PLMN, lac: "3987", ci "01EB7F01", GSM RAT.
AT+CSQ	+CSQ: 22,0 OK	Given that the ME is in GSM RAT, RSSI is 22 and BER is less than 0.2%.
AT+CESQ	+CESQ: 21,99,255,255,255,255 OK	Given that the current serving cell is a GERAN CELL, <rsrp>,<ecp0>,<rsrq> and <rsrp> are set as "not detectable". Instead, the value of the <rxlev> parameter is 21 (-90 dBm) while the <ber> is 99 ("not detectable").
AT+CREG?	+CREG: 1,"0FAB","01E28000",7 OK	The ME is in registered with the home PLMN, lac: "0FAB", ci "01E28000", LTE RAT.
AT+CSQ	+CSQ: 10,5 OK	Given that the ME is in LTE RAT, the RSRP is 10 and the RSRQ is in the range [22-26].
AT+CESQ	+CESQ: 99,99,255,255,23,47 OK	Given that the current serving cell is a E-UTRA cell, <rxlev>,<ber>,<rsrp> and <ecp0> are set as "not detectable". Instead, <rsrq> is 23 and <rsrp> is 47 (-94 dBm)

 When the RAT is 2G or 3G, a low value of the <qual> output parameter of the +CSQ AT command (the second one) means a higher quality of the signal. When the RAT is 4G, instead, a higher signal quality is mapped on a higher <qual> value.

## 7.2 Conference calls

As defined in 3GPP TS specifications, specific supplementary services can be activated to provide further information before or during the call.

An example is shown below.

Command	Response	Description
AT+CCWA=1,1,32	OK	Enable the call waiting URC.
AT+CLIP=1	OK	Enable the "Connected Line Identification Presentation" supplementary service.
AT+CLCC	OK	List the active calls. In this moment, no call is active.
ATD6638	OK	Call the number 6638.
AT+CLCC	+CLCC: 1;0;2;0;0;"6638";129 OK	Call #1, dialing.
AT+CLCC	+CLCC: 1;0;3;0;0;"6638";129 OK	Call #1, alerting.
AT+CLCC	+CLCC: 1;0;0;0;0;"6638";129 OK	Call #1, active.

Command	Response	Description
	RING	
	+CLIP: "6040",145,,,,0	URC signaling that there is an incoming call from the number 6040.
	+CCWA: 6040",145,1,,0	URC signaling that the call from number 6040 is in waiting.
AT+CLCC	+CLCC: 2;1;5;0;0;"6040";129 OK	Another call, call #2, is waiting.
AT+CHUP	OK	Hang up the active call

 On TOBY-L2 series modules the waiting tone mutes the audio of the current active call. To avoid this, it is possible to issue the AT+UDCONF=33,0 command to disable the waiting call tone locally generated.

## 8 Audio interface and parameters

TOBY-R2
LARA-R2

Not supported by LARA-R204 and LARA-R220.

Uplink and downlink paths coexist in the module, and the audio driver is responsible for switching between the paths.

The block diagram of the audio interface is depicted in the following figure, as in the u-blox AT Commands Manual [1].

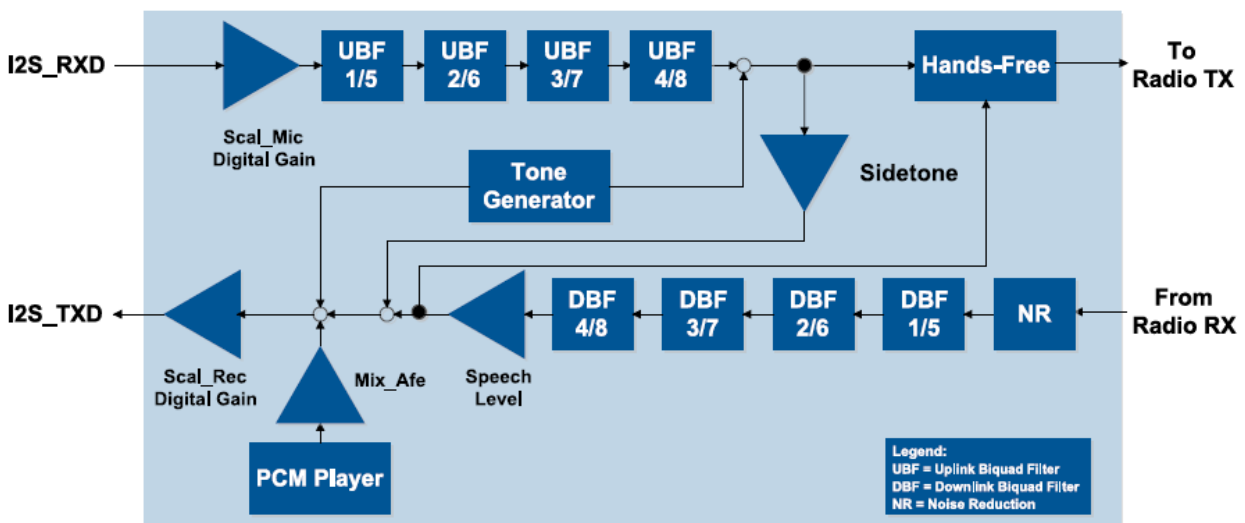

It is possible to configure five different downlink and uplink paths (id 0-4). The configuration of the parameters in each of the paths is possible through a dedicated set of AT commands.

A simple example is shown below.

Command	Response	Description
AT+UMGC=1,,2400	OK	Configuration of a digital gain 2400 on the uplink path #1.
AT+CLVL=80	OK	Setup of the downlink speech level to 80.
AT+USGC=1,,16384,16384	OK	Configuration of the gains of the digital amplifier on the downlink path #1.
AT+USTN=1,0	OK	Configuration of the sidetone gain for the uplink path #1.
AT+UUBF=0,1,0,0,0,0,32767	OK	Setup of the digital audio filter parameters for the uplink path #1.
AT+UHFP=1,0x0164,,,,,0,100,200,16384,7500,7500,2,150,150,150,60,60,60	OK	Setup of the Hands-Free Parameters on the uplink path #1: 0x0164 stands for EC adaptation on, noise reduction works with additional AGC, noise reduction on and AGC on. Other settings: add_atten: 0, min_atten: 100, max_atten: 200, nr_sw_2: 16384, nr_u_fak_0: 7500, nr_u_fak: 7500, ec_block_length:2, ec_nr_coeff_real: 150, ec_nr_coeff_complex1 150, ec_nr_coeff_complex2: 150, ec_nr_coeff_complex3: 60,



Command	Response	Description
		ec_nr_coeff_complex4: 60, ec_nr_coeff_complex5: 60.
AT+USPEECHINFO=1	OK	Enable the speech codec “codec GSM Half Rate” and the corresponding URC.
AT&W0	OK	Save the configuration in the NVM Profile #0.

## 9 Dynamic DNS AT command

LISA-U2

SARA-G3

SARA-U2

TOBY-L2

TOBY-R2

LARA-R2

 Not supported by SARA-G300 / SARA-G310 modules.

Before using the dynamic DNS AT command, define and save an appropriate internal PSD context. See the section [5.3](#).

Before using the dynamic DNS client, register a dynamic domain name with one of the supported service providers. After this procedure, the values to be used as domain name, username and password will be available.

Command	Response	Description
Configure an internal PDP context without activating it (see section <a href="#">4.2</a> )		Preliminary operation.
AT+UDYNDNS=1,1,"my.registered.domain","my_username","my_password"	OK	Enable the Dynamic DNS client to work with service provider "DynDNS.org", updating domain "my.registered.domain" and authenticating with username "my_username" and password "my_password".
	+UUDYNDNS: 1,0	The client is enabled.
AT+UPSDA=0,3	OK	Activate the internal PDP context #0.
	+UUDYNDNS: 2,4	DNS update is successfully executed.

## 10 TCP/IP AT commands

LEON-G1
LISA-U2
SARA-G3
SARA-G4
SARA-U2
TOBY-L2
TOBY-R2
LARA-R2

Not supported by SARA-G300 / SARA-G310 modules.

Verify that the module is registered with the network, and a GPRS connection is activated. Follow the steps in section 5.

### 10.1 Socket connect

Command	Response	Description
AT+USOCR=6	+USOCR: 0 OK	TCP socket creation. In this example socket #0 is created. The information text response returns the created socket identifier (in this case #0). If a new socket is created (without closing the already existent), a new socket identifier will be returned.
AT+USOCR=6	+USOCR: 1 OK	Create another socket (in this case the socket identifier is 1).
AT+USOCL=1	OK	Close socket #1. The socket #1 is free.
AT+UDNSRN=0, "ftp.u-blox.com"	+UDNSRN: "195.34.89.241" OK	DNS resolution of the URL "ftp.u-blox.com".
AT+USOCO=0, "195.34.89.241", 7	OK	Connect socket #0 to port 7 of a remote host with IP address 195.34.89.241. <b>The connection is now uniquely associated to the socket. The socket is now ready for read / write operations.</b>
AT+USOCO=0, "195.34.89.241", 7	ERROR  +UUSOCL: 0	If the connection is not successfully performed, an error result code is returned and the socket used for the connection attempt <u>is closed</u> . The notification is provided by +UUSOCL URC.

### 10.2 Socket listening

Command	Response	Description
AT+USOCR=6	+USOCR: 0 OK	TCP socket creation with ID #0.
AT+USOLI=0, 1099	OK	Set the socket in listening mode on port 1099. The ability to reach the opened port on the server depends also on the network operator. Some network operators do not allow incoming connection on opened TCP/UDP port.
	+UUSOLI: 1, "151.9.34.66", 39912, 0, "151.9.34.74", 1099	When a connection request arrives from a remote host, a new socket is created with the first integer identifier available. In this example the socket ID is #1. The +UUSOLI URC indicates: <ul style="list-style-type: none"> <li><b>1:</b> the new socket created. Incoming data from the established connection will be received on this socket. Data to be sent must be written into this socket</li> </ul>

Command	Response	Description
		<ul style="list-style-type: none"> <li>• <b>151.9.34.66</b>: IP of the remote server</li> <li>• <b>39912</b>: service port</li> <li>• <b>0</b>: listening socket. It is the socket identifier specified with the +USOLI AT command</li> <li>• <b>151.9.34.74</b>: module IP address</li> <li>• <b>1099</b>: listening port assigned to the connection. Configured with the +USOLI AT command</li> </ul> Socket #1 is now ready for reading/writing data
	+UUSORD: 1,18	18 bytes of incoming data over the previously established connection.  The incoming data will always be sent on the related socket.

## 10.3 Socket write

### 10.3.1 Binary mode

Command	Response	Description
AT+USOWR=0,2	@	Request to write 2 data bytes into socket #0. Wait "@" symbol indicating the data prompt is now open (AT commands are not allowed in data prompt). After the @ prompt reception, wait for a minimum of 50 ms before sending data.
12	+USOWR: 0,2 OK	Write data bytes. It is not allowed to write fewer bytes than previously specified with AT+USOWR command. If more bytes are written respect to the threshold, the remaining bytes will be truncated. The interface is blocked until all bytes are written. If the final result code is returned then the data is sent to lower level of protocol stack. <b>This is not a notification of an acknowledgment received from the remote host data bytes have been sent to.</b>

### 10.3.2 Base syntax



Command	Response	Description
AT+USOWR=0,2,"12"	+USOWR: 0,2 OK	Write 2 data bytes data on socket #0. If the final result code is returned then the data is sent to lower level of protocol stack. <b>This is not an acknowledgment from the remote host where the data bytes were sent.</b>  Some characters are not allowed in base syntax mode. Check the u-blox AT Commands Manual [1] for the allowed characters.

### 10.3.3 Queue FULL

Command	Response	Description
AT+USOWR=0,2,"12"	ERROR	If the socket buffer is full, then the data bytes inserted in data prompt will be discarded: this may happen if the network is congested or if network coverage is lost. <b>In this case an error result code is returned.</b>
AT+USOCTL=0,10	+USOCTL: 0,10,4 OK	In case of an error result code, it is recommended to query the state of TCP connection associated to the socket to verify the socket is still connected. The third parameter of the +USOCTL URC is the state; if its value is 4, it means the connection is established.
AT+USOCTL=0,11	+USOCTL: 0,11,0 OK	It is also possible to query for TCP outgoing unacknowledged data of the socket (this command is valid only for TCP socket). In this case, 0 bytes of data is unacknowledged.

### 10.3.4 GSM network coverage lost

#### 10.3.4.1 First scenario: network coverage lost after AT+USOWR command

Command	Response	Description
AT+CREG=1	OK	Enable the network registration URC.
AT+UDNSRN=0,"ftp.u-blox.com"	+UDNSRN: "195.34.89.241" OK	DNS resolution of the URL "ftp.u-blox.com".
AT+USOCO=0,"195.34.89.241",7	OK	Connect socket #0 to port 7 of a remote host with IP address 195.34.89.241. <b>In this example an echo server has been used.</b> The socket is now ready for read / write data.
AT+USOWR=0,3	@	Request to write 3 data bytes on socket #0. Wait for "@" symbol indicating the data prompt is now open (AT commands are not allowed in data prompt). After the @ prompt reception, wait for a minimum of 50 ms before sending data.
123	+USOWR: 0,3 OK	Write data bytes.  It is not allowed to write fewer bytes than previously specified with AT+USOWR command.  If more bytes are written respect to the threshold, the remaining bytes will be truncated. The interface is blocked until all bytes are written. If the final result code is returned, then the data is sent to lower level of protocol stack. <b>This is not an acknowledgment from the remote host where the data bytes were sent.</b>
	+UUSORD: 0,3	Remote TCP test server sent back data.
		Coverage lost may be simulated by disconnecting the antenna from the module. In this case the signal coverage is missing.
	+CREG: 2	The module is not registered with a mobile network. Currently in "search" mode.



Command	Response	Description
	+UUSORD: 0,100	Remote TCP test server sent back data. <b>This means data was sent immediately after network coverage was reestablished.</b>

## 10.4 Socket operations with "Keep Alive" option

 In "Keep Alive" mode, the module periodically sends dummy TCP packets to prevent the network from closing the inactive context. The network operator may close inactive TCP connections without notification to the mobile.

Command	Response	Description
AT+USOCR=6	+USOCR: 0 OK	Create a TCP socket #0.
AT+USOSO=0,65535,8,1	OK	Enable the "keep alive" option. This socket option enables the module to send dummy IP packets to keep the connection alive. <ul style="list-style-type: none"> <li>• <b>0</b>: socket number to be set to enable keep alive option</li> <li>• <b>65535</b>: specify socket level option</li> <li>• <b>8</b>: specify the "Keep Alive" option</li> <li>• <b>1</b>: enable the keep alive (set to 0 to disable it)</li> </ul>
AT+USOSO=0,6,2,30000	OK	Set the inactivity timeout after which the module will start to send "keep alive" packets. <ul style="list-style-type: none"> <li>• <b>0</b>: socket number to be set to enable keep alive option</li> <li>• <b>6</b>: specify TCP level option</li> <li>• <b>2</b>: specify option TCP "keep alive" timer option</li> <li>• <b>30000</b>: module will send dummy TCP packets every 30000 ms</li> </ul>

## 10.5 Socket read

### First scenario

Command	Response	Description
	+UUSORD: 0,2	Remote server sends 2 data bytes on socket #0. A URC is returned indicating the socket on which the data is received and the total amount of data received.
AT+USORD=0,2	+USORD: 0,2,"ar" OK	Read data. The data is returned between quotation marks.

### Second scenario

Command	Response	Description
	+UUSORD: 0,30	The remote server sends 30 data bytes on socket #0. If a socket buffer is empty, the +UUSORD URC indicates a TCP packet has been received from the remote host the socket is connected to and the amount of data bytes of the packet.
AT+USORD=0,10	+USORD: 0,10,"hfgyrhgfty" OK	Read only part of data (in this example 10 bytes of data are read). Data is returned between quotation marks.



Command	Response	Description
	+UUSORD: 0,20	The +UUSORD URC indicates the total amount of data bytes stored in the buffer after the last +USORD AT command execution. In this example 20 bytes are stored in the buffer.

### Third scenario

Command	Response	Description
		The remote server sends 30 data bytes on socket #0.
	+UUSORD: 0,30	If a socket buffer is empty +UUSORD URC indicates a TCP packet has been received from the remote host the socket is connected to and the amount of data bytes of the packet.
AT+USORD=0,10	+USORD: 0,10,"hfgyrhgfty" OK	Only part of the data bytes (10 bytes in this example) are read. The data is returned between quotation marks.
	+UUSORD: 0,25	The remote server sent more data after the first part was received. The +UUSORD URC indicates the total amount of data bytes stored the buffer after the last +USORD AT command execution. In this example 25 bytes are stored in the buffer.
AT+USORD=0,10	+USORD: 0,10,"hfgbchs7[o" OK	Only part of the data bytes (10 bytes in this example) is read. Data is returned between quotation marks.
	+UUSORD: 0,34	The remote server sent more data. The +UUSORD URC indicates the total amount of data bytes stored the buffer after the last +USORD AT command execution. In this example 34 bytes are stored in the buffer.
AT+USORD=0,34	+USORD: 0,34,"jghfbv74ksHDFUE çpjè0'@èpyujfnvhfyù" OK	All the bytes are read.
AT+USORD=0,0	+USORD: 0,0 OK	Verifies how much unread data is in the buffer. In this example 0 bytes are in socket #0.



**Fourth scenario**

Command	Response	Description
	+UUSORD: 0,30	The remote host sends 30 bytes of data on the socket #0. If a socket buffer is empty the +UUSORD URC indicates a TCP packet has been received from the remote host the socket is connected to and the amount of data bytes of the packet.
AT+USORD=0,10	+USORD: 0,10,"hfgyrhgfty" OK	Only part of the data bytes (10 bytes in this example) are read. Data is returned between quotation marks.
	+UUSORD: 0,25	The remote server sent other data after the first data bytes had been received. The +UUSORD URC indicates the total amount of data bytes stored the buffer after the last +USORD AT command execution. In this example 25 bytes are in the buffer.
AT+USOWR=0,3	@	The remote host closes the TCP connection associated to socket #0. Request to write 3 data bytes into the socket #0. Wait for "@" symbol indicating the data prompt is now open. After the @ prompt reception, wait for a minimum of 50 ms before sending data.
123	+USOWR: 0,0 OK	Write data. After the last byte the data prompt is closed.  It is not allowed to write fewer bytes than previously specified with AT+USOWR command.  If more bytes are written respect to the threshold, the remaining bytes will be truncated. The interface is blocked until all bytes are written. The +USOWR: 0,0 URC indicates 0 bytes have been sent to the remote host. <b>This means the TCP connection is now closed.</b>
AT+USORD=0,25	+USORD: 0,25,"23dfgt5uhj89ikd ftevlpazwe" OK	Read the remaining data bytes still stored in the buffer of socket #0.
	+UUSOCL: 0	The URC indicates the TCP connection associated to socket #0 is now closed and socket #0 is cleared.

## 10.6 Socket state

For a detailed description of TCP socket states, see the +USOCTL command description in u-blox AT Commands Manual [\[1\]](#).

Command	Response	Description
AT+USOCTL=0,0	+USOCTL: 0,0,6 OK	Query the socket type of the socket #0. The socket type information is provided by the third parameter (in this case 6 – TCP).
AT+USOCTL=0,10	+USOCTL: 0,10,4 OK	It is possible to query the state of TCP connection associated with the socket; in this example the socket #0 (this command is valid only for TCP socket). The third parameter of information text response provides the socket status (in this case 4 - the socket is in ESTABLISHED status).

Command	Response	Description
AT+USOCTL=0,10	+USOCTL: 0,10,7 OK	The third parameter of the information text response provides the socket status (in this case 7 - a TCP connection termination procedure is being performed).
AT+USOCTL=0,11	+USOCTL: 0,11,0 OK	Query for TCP outgoing unacknowledged data of the socket #0 (this command is valid only for TCP socket). In this case 0 bytes of data are unacknowledged.
AT+USOCTL=0,1	+USOCTL: 0,1,0 OK	Query for the last socket error for socket #0. If there are not errors the value is 0.

## 10.7 Socket close

### By remote server

Command	Response	Description
	+UUSOCL: 1	The URC indicates the TCP connection associated to socket 1 is closed. The socket #1 is cleared.   After this indication has been received the socket buffer is cleared.

### By the module



Command	Response	Description
AT+USOCL=0	OK	The socket is closed by the module (socket #0).   No +UUSOCL URC returned.

## 10.8 Direct link

### 10.8.1 Enter and exit from Direct link mode

 Not all the u-blox cellular modules support +UDCONF=5 / +UDCONF=6 / +UDCONF=7 AT commands: see u-blox AT Commands Manual [\[1\]](#) for the products supporting these commands.

Command	Response	Description
AT+USOCLR=6	+USOCLR: 0 OK	TCP socket creation. In this example the socket #0 is created.  The information text response provides the new socket identifier (in this example #0). If a new socket is created, a new socket identifier will be returned.
AT+UDNSRN=0,"ftp.u-blox.com"	+UDNSRN: "195.34.89.241" OK	DNS resolution of the URL "ftp.u-blox.com".
AT+USOCO=0,"195.34.89.241",7	OK	Connect the socket #0 to port 7 of a remote host with IP address 195.34.89.241.  The connection is now uniquely associated to the socket. The socket is now ready for read / write operations.
AT+UDCONF=5,0,250	OK	Set the timer trigger to 250 ms. Set the trigger after the socket creation and before switching to direct link mode.   This step is not mandatory.

Command	Response	Description
AT+UDCONF=6,0,400	OK	Set the data length trigger to 400 bytes. Set the trigger after the socket creation and before switching to direct link mode.  This step is not mandatory.
AT+UDCONF=7,0,37	OK	Set the character trigger to "%", which corresponds to the value 37 in the ASCII table. Set the trigger after the socket creation and before switching to direct link mode.  This step is not mandatory.
AT+USODL=0	CONNECT	Activate the direct link mode for the socket #0. The CONNECT intermediate result code means a transparent end-to-end communication has been established with the previous connected TCP socket via the serial interface. Now data received on socket #0 will be redirected to the serial port and data written on serial port will be sent to socket #0.
+++	DISCONNECT OK	Exit from direct link mode; <b>this will not close the TCP connection.</b> Now the module is in command mode. The data can be read or written on the socket #0 using usual TCP commands (+USOWR, +USORD).  The "DISCONNECT" result code is not supported by LEON-G1 / LEON-G2 "03" and previous versions.
AT+USODL=0	CONNECT	Reactivate direct link mode for socket #0. Now data received on socket #0 will be redirected to the serial port and data written on serial port will sent to socket #0.

## 10.8.2 Closing a connection

Command	Response	Description
+++	DISCONNECT OK	Exit from the direct link mode to the command mode. The TCP connection is not closed.  The "DISCONNECT" result code is not supported by LEON-G100-03S / LEON-G200-03S and previous versions.
AT+USOCL=0	OK	Clear the socket the connection is associated to.

## 10.8.3 Connection closed by remote host

Command	Response	Description
	DISCONNECT OK +UUSOCL: 0	If the remote host closes the connection while a socket is in direct link mode the module exits from the direct link mode. The "OK" final result code and the indication of the socket number that has been closed is returned. The closure notification will be received only after all data stored in the socket buffer is written into the serial port.  The "DISCONNECT" result code is not supported by LEON-G100-03S / LEON-G200-03S and previous versions.

- For more details on "+++" escape sequence see the section [12.1.4](#).
- On LEON-G1/LEON-G2 "07" and previous versions, if a context deactivation occurs, then the open sockets become invalid. Close them and reinitialize TCP connections.

## 10.9 Socket Always On

LISA-U2
SARA-G3
SARA-G4
SARA-U2

- Not supported by LISA-U1 series or by LISA-U2 "01" and previous versions.
- Not supported by SARA-G300 / SARA-G310 modules.

Before using the Socket Always On (SAO), define and save three internal PSD contexts (see section [5.3](#)).

### 10.9.1 Client configuration

Command	Response	Description
AT+USOAO=1,3	OK	Set the PDP profile 3 as default connection to be activated after the module start-up.
AT+USOAO=2,0	OK	Set the client mode.
AT+USOAO=3,"somehost.somedomain.com"	OK	Set the remote host for the TCP connection. The value can also be an IP address.
AT+USOAO=4,8448	OK	Set the remote port for the TCP connection.
AT+USOAO=5,17	OK	Set the protocol to use: 17 stands for UDP.
AT+USOAO=10,"1234"	OK	Set the PIN "1234" to be used at the start-up.
AT+USOAO=0,1	OK	Enable the SAO functionality.
AT+CPWROFF	OK	Shut down the module. On the next boot the functionality is active.

### 10.9.2 Client operation

After the client configuration is done (as described in the section [10.9.1](#)) and the module power on, it is assumed that the network is available, the PIN is correctly configured, the PSD profile #3 can be activated, the somehost.somedomain.com (whose IP address is e.g. 123.45.67.89) server is alive, reachable and accepts the incoming connection:

Command	Response	Description
	+UUSOAO: "123.45.67.89",8448	The remote host has accepted the connection from the module. The Direct Link is active.

### 10.9.3 Server configuration

Command	Response	Description
AT+USOAO=1,3	OK	Set PDP profile 3 as default connection to be activated after the module start-up.
AT+USOAO=2,1	OK	Set the server mode.
AT+USOAO=4,8448	OK	Set the listening port: incoming TCP connection need to be directed to this port.
AT+USOAO=10,"1234"	OK	Set the PIN "1234" to be used at startup.
AT+USOAO=20,"123.45.67.89"	OK	Set an acceptable IP address in the "white list". Up to 10 IP addresses (AT+USOAO=20,"..." ... AT+USOAO=29,"...") can be configured.

Command	Response	Description
AT+USOAO=5,6	OK	Set the protocol to use: 6 stands for TCP
AT+USOAO=0,1	OK	Enable the SAO functionality.
AT+CPWROFF	OK	Shut down the module. On the next boot the functionality is active.

## 10.9.4 Server operation

After the server configuration is done (as described in section 10.9.3) and the module power on, it is assumed that the network is available, the PIN is correctly configured, the PSD profile #3 can be activated, the server at 123.45.67.89 is alive and can reach the module (whose assigned address is e.g. 123.42.65.87):

Command	Response	Description
	+UUSOAOI: "123.42.65.87",8448	The module has been assigned the IP address 123.42.65.87 and started listening on the local port 8448 for incoming connections.
	+UUSOAOI: "123.45.67.89",1000	The module has accepted the connection coming from 123.45.67.89:1000. From now on Direct Link is active.

## 10.10 IP Change notification

LISA-U2

SARA-G3

SARA-G4

SARA-U2



Not supported by LISA-U1 series or by LISA-U2 "01" and previous versions.



Not supported by SARA-G300 / SARA-G310 modules.



Command	Response	Description
AT+UPSD=0,1,"web.omnitel.it"	OK	Set up the APN for GPRS connection profile "0". APN "web.omnitel.it" is an example only. Use the APN operator.
AT+UPSDA=0,3	OK	Activate the GPRS connection.
AT+UIPCHGN=1,"trackingserver.com",4300,"modem_ip_notify.php",1,0,"","","Pet Tracker"	OK	Configure the IP change notification (CN) feature to send to the server "trackingserver.com" on port 4300 the IP CN. No username or password required. IMEI to be sent but not IMSI. The server path is "modem_ip_notify.php". Use as custom info "Pet Tracker". If the IP CN feature is enabled, then the notification is performed every time the PDP context is activated. If the client is enabled when a PDP connection is already active, it starts to update IP address on the next PDP context activation.
AT+UPSDA=0,4	OK	Disable the GPRS connection.

Command	Response	Description
AT+UPSDA=0,3	OK	<p>Activate the GPRS connection.</p> <p>In this way the IP CN is forced to the server. The request sent from modem to server is (IP and IMEI values below are just for example):</p> <pre>GET /modem_ip_notify.php?myip=123.56.214.2&amp;imei=992237050009739&amp;imsi= &amp;user=&amp;pass=&amp;cust=Pet+Tracker HTTP/1.0{CRLF} Host: trackingserver.com{CRLF} User-Agent: u-blox IP Change Notification Agent 1.0{CRLF} {CRLF}</pre>
	+UUIPCHGN: 200,"IP_UPDATED"	The server replies with the custom information ("IP_UPDATED") and a code (200) that means no errors.

## 10.11 Verizon socket configuration

TOBY-L201

LARA-R204

Command	Response	Description
AT+UMNOCONF=3,7	OK	<p>The Verizon configuration is set with:</p> <ul style="list-style-type: none"> <li>the internal connection manager active</li> <li>VZWINTERNET context not handled by VZW connection manager</li> </ul>
AT+CFUN=16	OK	Reboot the module to apply the new configuration.
AT+CGDCONT=3,"IPV4V6","VZWINTERNET"	OK	<p>Check on which context is defined the APN3 (+CGDCONT read command), if not, define a PDP context with the APN3. In this case CID=3 has been used.</p> <p> On LARA-R204 CID=1 is reserved for the initial default bearer, and on TOBY-L201 CID=4 is reserved for the initial default bearer.</p>
AT+CGACT=1,3	OK	Activate manually the PDP context with APN3.
AT+UPSD=0,100,3	OK	The internal profile 0 is mapped on the CID where the APN3 has been defined and activated. In this example CID=3.
AT+UPSD=0,0,2	OK	Set the PDP type as defined in the PDP context for the CID associated with APN3. In this case set the PDP type to IPv4v6 with IPv4 preferred for the internal socket.
AT+UPSDA=0,3	OK	<p>Activate the PSD profile 0</p> <p> There is no need to insert the APN because a PDP context (CID=3) already defined is used.</p>
	+UUPSDA: 0,"215.26.32.198"	URC indicating that the PSD profile has been successfully activated and the IP address assigned to the internal context (this IP matches the IP of PDP context with APN3).

## 10.12 AT&T socket configuration

TOBY-L2

LARA-R2



See the module data sheet for the list of AT&amp;T certified modules.

Command	Response	Description
AT+UMNOCNF=2	OK	The AT&T configuration is set: IMS service is disabled, Verizon connection manager is disabled, 3G bands are enabled, all supported 4G bands are enabled, HSDPA category set to 14.
AT+CFUN=16	OK	Reboot the module to apply the new configuration.
AT+COPS?	+COPS: 0,0,"AT&T",7 OK	The module is registered on 4G network.
AT+UPSD=0,100,4	OK	Suppose that the default bearer is CID=4 and it is not possible to activate another context, so profile 0 is mapped on CID=4.
AT+UPSD=0,0,0	OK	Set the PDP type to IPv4 for the internal socket (AT&T requires IPv4).
AT+UPSDA=0,3	OK	Activate the PSD profile #0.  There is no need to insert the APN because a PDP context (CID=4) already defined is used.
	+UUPSDA: 0,"215.26.32.198"	The URC indicates that the PSD profile has been successfully activated and the IP address assigned to the activated PDP context.
AT+CFUN=16	OK	Reboot the module.
AT+COPS?	+COPS: 0,0,"AT&T",2 OK	The module is registered on 3G network.
AT+UPSD=0,1,"<AT&T_apn>"	OK	There is no default bearer already activated, the user shall define the PSD profile's APN.
AT+UPSDA=0,3	OK	Activate the PSD profile #0. The PSD context is activated on CID=8.
	+UUPSDA: 0,"215.26.32.198"	The URC indicates that the PSD profile has been successfully activated and the IP address assigned to the activated PDP context.

# 11 UDP/IP AT commands

LEON-G1
LISA-U2
SARA-G3
SARA-G4
SARA-U2
TOBY-L2
TOBY-R2
LARA-R2

Not supported by SARA-G300 / SARA-G310 modules.

## 11.1 Socket write (+USOST)

Command	Response	Description
AT+USOCR=17	+USOCR: 0 OK	UDP socket creation. In this example the socket #0 is created.  The information text response returns the new socket identifier (in this example #0). If a new socket is created, a new socket identifier will be returned.
AT+USOCR=17,12000	+USOCR: 0,12000 OK	The local port to be used for data sending can be configured during the UDP socket creation. In this example the socket #0 is created and bound with port 12000. Data written on socket #0 will be sent from this specific port.
AT+UDNSRN=0,"ftp.u-blox.com"	+UDNSRN: "195.34.89.241" OK	DNS resolution of the URL "ftp.u-blox.com".
AT+USOST=0,"195.34.89.241",7,2 @		Request to write 2 bytes of data into socket #0 specifying IP address and UDP port of the remote host UDP packet has to be sent to. Wait for "@" symbol indicating the data prompt is now open (AT commands are not allowed in data prompt).
12	+USOST: 0,2 OK	Write data. After the last data byte is written, the prompt is closed.  It is not allowed to write fewer bytes than previously specified with AT+USOST command.  If more bytes are written with respect to the threshold, the remaining bytes will be truncated.  The interface is blocked until all bytes are written. The final result code is returned. This means the data is sent to lower level of protocol stack. This is not an acknowledgment, UDP is a connectionless protocol.

## 11.2 Socket read (+USORF)

Command	Response	Description
	+UUSORD: 0,2	A UDP packet with 2 data bytes has been received.
AT+USORF=0,2	+USORF: 0,"195.34.89.241",7,2,"12" OK	Read data. The information text response indicates: <ul style="list-style-type: none"> <li>• Read socket identifier</li> <li>• Remote IP address</li> <li>• Remote UDP port</li> <li>• Number of read data bytes</li> <li>• Read data bytes (between quotation marks)</li> </ul>
	+UUSORD: 0,20	UDP packet with 20 data bytes has been received from the remote server.





Command	Response	Description
AT+USORF=0,10	+USORF: 0,"195.34.89.241",7,2, "1234567890" OK +UUSORD: 0,10	Read 10 data bytes.  The +UUSORD URC indicates that 10 bytes are still unread.  The remote host sends a UDP packet with 20 data bytes.
AT+USORF=0,10	+USORF: 0,"195.34.89.241",7,2, "1234567890" OK +UUSORD: 0,20	Read the remaining 10 data bytes of the previous packet. The URC indicates 20 data bytes have been received and are still stored in the socket buffer.   After the first URC has been returned, a second URC is returned (only after a reading operation) indicating: <ul style="list-style-type: none"> <li>• If a reading operation of a packet is not finished it will provide the remaining data of the specific packet</li> <li>• Otherwise it will provide the number of data bytes of packets stored in the socket buffer</li> </ul>

 For UDP it is highly recommended to use +USOST and +USORF AT commands instead of +USOCO, +USOWR and +USORD.

## 11.3 Socket write (+USOWR)

Command	Response	Description
AT+USOCR=17	+USOCR: 0 OK	UDP socket creation. In this example the socket #0 is created.  The information text response returns the new socket identifier (in this example #0). If a new socket is created (without closing the already existent), a new socket identifier will be returned.
AT+USOCR=17,12000	+USOCR: 0,12000 OK	The local port to be used while sending data can be configured during the UDP socket creation. In this example Socket #0 is created and bound with port 12000. Data written on socket #0 will be sent from this specific port.
AT+UDNSRN=0,"ftp.u-blox.com"	+UDNSRN: "195.34.89.241" OK	DNS resolution of the URL "ftp.u-blox.com".
AT+USOCO=0,"195.34.89.241",7	OK	Specify the IP address of the remote server and TCP port where UDP packets have to be sent. <b>UDP is a connectionless protocol, reception of UDP packets is not guaranteed, the +USOCO AT command does not establish a connection.</b> The socket is now ready for data sending to the remote server or for receiving data from the remote server.
AT+USOWR=0,2	@	Request to write 2 bytes of data into the socket #0. Wait for "@" symbol indicating the data prompt is now open (AT commands are not allowed in data prompt). After the @ prompt reception, wait for a minimum of 50 ms before sending data.

Command	Response	Description
12	+USOWR: 0,2 OK	<p>Write data. After the last byte the data is written, the prompt is closed.</p> <p> It is not allowed to write fewer bytes than previously specified with AT+USOWR command.</p> <p> If more bytes are written with respect to the threshold, the remaining bytes will be truncated.</p> <p>The interface is blocked until all bytes are written.</p> <p>The information text response and the final result code are returned. This means the data is sent to lower level of protocol stack. This is not an acknowledgment.</p>

## 11.4 Socket read (+USORD)

Command	Response	Description
	+UUSORD: 0,2	A UDP packet with 2 data bytes has been received from the remote server.
AT+USORD=0,2	+USORD: 0,2,"23" OK	Read the data.
	+UUSORD: 0,20	A UDP packet with 2 data bytes has been received from remote server.
AT+USORD=0,10	+USORD: 0,10,"1234567890" OK	Read 10 bytes of data. The URC indicates that 10 bytes are still unread.
	+UUSORD: 0,10	The UDP packet with 20 byte of data received from remote server.
AT+USORD=0,10	+USORD: 0,10,"1234567890" OK	Read the remaining 10 data bytes of the previous packet. The URC indicates 20 data bytes has been received and are still stored in the socket buffer.
	+UUSORD: 0,20	<p> After the first URC has been returned, a second URC is returned (only after a reading operation) indicating:</p> <ul style="list-style-type: none"> <li>• If a reading operation of a packet is not finished it will be provided the remaining data of the specific packet</li> <li>• Otherwise it will provide the number of data bytes of packets stored in the socket buffer</li> </ul>

 If the UDP socket is not set in listening mode (see +USOLI AT command) it will not be possible to receive any packet if a previous write operation is not performed.

## 12 FTP AT commands

LEON-G1
LISA-U2
SARA-G3
SARA-G4
SARA-U2
TOBY-L2
TOBY-R2
LARA-R2

Not supported by SARA-G300 / SARA-G310 modules.

Make sure to follow the steps in "[PS data connection](#)" (section 5) before using the AT commands in this section.

Command	Response	Description
		Parameter configuration for FTP server connection. These parameters will be set:
AT+UFTP=1,"ftp.u-blox.com"	OK	• FTP server hostname
AT+UFTP=2,"anonymous"	OK	• FTP username
AT+UFTP=3,"user@somedomain.com"	OK	• FTP password
AT+UFTP=6,0	OK	• FTP connection mode (ACTIVE connection)
AT+UDNSRN=0,"ftp.u-blox.com"	+UDNSRN: "195.34.89.241" OK	Hostname resolution.
		Connect to the server and manage the FTP connection using the +UFTPC command. Let's start connecting to the server.
AT+UFTPC=1	OK	The +UUFTPCR URC provides the FTP command result (the last parameter provides the result, 1 if is successfully performed).
	+UUFTPCR: 1,1	
AT+UFTPC=13	OK	Request the file list on the server.
	+UUFTPCD: 13,194,"-rw-r--r-- 1 ftp ftp 1037 Aug 5 09:45 dat_000 -rw-r--r-- 1 ftp ftp 21041 Aug 5 09:12 data.zip -rw-r--r-- 1 ftp ftp 12 Aug 5 09:42 xlog.zip "	
	+UUFTPCR: 13,1	
AT+UFTPC=10,"uploads"	OK	Directory creation on the FTP server.
	+UUFTPCR: 10,1	
AT+UFTPC=13	OK	Request again the file list.
	+UUFTPCD: 13,258,"-rw-r--r-- 1 ftp ftp 1037 Aug 5 09:45 dat_000 -rw-r--r-- 1 ftp ftp 21041 Aug 5 09:12 data.zip drwxr-xr-x 2 ftp ftp 4096 Aug 5 09:48 uploads -rw-r--r-- 1 ftp ftp 12 Aug 5 09:42 xlog.zip "	
	+UUFTPCR: 13,1	
		Change directory to directory name "uploads".
AT+UFTPC=8,"uploads"	OK	Use AT+UFTPC=8,".." to return back in the parent directory.
	+UUFTPCR: 8,1	
AT+UFTPC=5,"gps_positions","gps_positions"	OK	Upload a file from the module to the FTP server from the local file system of the module (in this example filename "gps_positions").
	+UUFTPCR: 5,1	
AT+UFTPC=5,"gps_positions","gps_positions",250	OK	Restart the upload file from the module to FTP server from the local module file system (in this





Command	Response	Description
	+UUFTPCR: 5,1	example filename "gps_positions"), starting from byte 250.  The FTP server should support the REST command to support these functionalities. The server should write the file starting from byte indicated.  The restart feature is not supported by SARA-G3 / LISA-U2 "01" and previous versions and by LEON-G1 / LISA-U1 series.
AT+UFTPC=13	OK	File list request.
	+UUFTPCD: 13,70,"-rw-r--r-- 1 ftp ftp 176673 Aug 5 10:03 gps_positions"	
	+UUFTPCR: 13,1	
AT+UFTPC=8,".."	OK	Return to the parent directory.
	+UUFTPCR: 8,1	
AT+UFTPC=4,"data.zip","data.zip"	OK	Download a file from the FTP server to the local file system of the module.
	+UUFTPCR: 4,1	
AT+UFTPC=4,"data.zip","data.zip",1	OK	Restart the file download from the FTP server to the local module file system from the latest byte saved on file system (this is automatically calculated). The data received is written after latest byte available on file system.
	+UUFTPCR: 4,1	The restart feature is not supported by SARA-G3 / LISA-U2 "01" and previous versions and by LEON-G1 / LISA-U1 series.
AT+UFTPC=0	OK	FTP server disconnection.
	+UUFTPCR: 0,1	
AT+UPSDA=0,4	OK	GPRS connection detachment with the +UPSDA command.  Only the specified profile will be deactivated.

To list and view all files stored in the cellular module file system, see section [21](#).

## 12.1 Direct link

### 12.1.1 Retrieve a file from FTP server

Command	Response	Description
AT+UFTP=1,"ftp.u-blox.com"	OK	Parameter configuration for FTP server connection. These parameters will be set:
AT+UFTP=2,"anonymous"	OK	<ul style="list-style-type: none"> <li>FTP server hostname</li> </ul>
AT+UFTP=3,"user@somedomain.com"	OK	<ul style="list-style-type: none"> <li>FTP username</li> </ul>
AT+UFTP=6,0	OK	<ul style="list-style-type: none"> <li>FTP password</li> </ul>
AT+UDNSRN=0,"ftp.u-blox.com"	+UDNSRN: "195.34.89.241" OK	<ul style="list-style-type: none"> <li>FTP connection mode (ACTIVE connection)</li> </ul> Hostname resolution.
		Connect to the server and manage the FTP connection using the +UFTPC command.



Command	Response	Description
AT+UFTPC=1	OK  +UUFTPCR: 1,1	 The +UUFTPCR URC is returned when the connection is established.
AT+UFTPC=6,"file_to_retrieve"	CONNECT	Send to the FTP server a RETRIEVE file request for <code>file_to_retrieve</code> .  The CONNECT intermediate result code means the direct link mode is activated: the data received from FTP connection will be redirected to the serial port.
AT+UFTPC=6,"file_to_retrieve", 250	CONNECT	Restart a RETRIEVE file request for <code>file_to_retrieve</code> file from byte 250. The CONNECT intermediate result code means the direct link mode activation: the data received from FTP connection is redirected to the serial port. The data reception begins with the byte indicated.   The restart feature is not supported by SARA-G3 / LISA-U2 "01" and previous versions and by LEON-G1 / LISA-U1 series.
+++	DISCONNECT  OK  +UUFTPCR: 6,1	 When the file has entirely been retrieved the module does not exit from the direct link mode. It is necessary to manually exit using the "+++" escape sequence. The +UUFTPCR URC notifies how the retrieve operation has been concluded (1 means success).   The "DISCONNECT" result code is not supported by LEON-G1 / LEON-G2 "03" and previous versions.

## 12.1.2 Aborting retrieve file request

Command	Response	Description
+++	DISCONNECT  OK  +UUFTPCR: 6,0	If entering "+++" escape sequence before the requested file has been entirely retrieved from FTP server, the module exits from the direct link and the +UUFTPCR URC notifies that the retrieve operation has not been concluded successfully (0 means fail).   The "DISCONNECT" result code is not supported by LEON-G1 / LEON-G2 "03" and previous versions.

## 12.1.3 Store a file on FTP server

Command	Response	Description
AT+UFTP=1,"ftp.u-blox.com"	OK	Parameter configuration for FTP server connection. These parameters will be set:
AT+UFTP=2,"anonymous"	OK	<ul style="list-style-type: none"> <li>FTP server hostname</li> </ul>
AT+UFTP=3,"user@somedomain.com"	OK	<ul style="list-style-type: none"> <li>FTP username</li> </ul>
"		<ul style="list-style-type: none"> <li>FTP password</li> </ul>

Command	Response	Description
AT+UFTP=6,0	OK	<ul style="list-style-type: none"> <li>FTP connection mode (ACTIVE connection)</li> </ul>
AT+UDNSRN=0,"ftp.u-blox.com"	+UDNSRN: "195.34.89.241" OK	Hostname resolution.
AT+UFTPC=1	OK  +UUFTPCR: 1,1	Connect to the server and manage the FTP. Connection using the +UFTPC command. Let's start connecting to the server.   +UUFTPCR URC is returned when the connection is established.
AT+UFTPC=7,"file_to_store"	CONNECT	Send to FTP server a STORE file request for <code>file_to_store</code> .  The CONNECT intermediate result code means the direct link mode is activated: the data sent through the serial port will be redirected to the FTP server through the FTP connection.
AT+UFTPC=7,"file_to_store",250	CONNECT	Restart the STORE file request for <code>file_to_store</code> from byte 250. The CONNECT intermediate result code means the direct link mode activation: the data sent through the serial port is redirected to the FTP server through the FTP connection. The data is written on the FTP server starting from byte indicated.   The FTP Server should support REST command to support this functionality.   The restart feature is not supported by SARA-G3 / LISA-U2 "01" and previous versions and by LEON-G1 / LISA-U1 series.
+++	DISCONNECT  OK  +UUFTPCR: 7,1	When the data upload is completed use the "+++" escape sequence for exiting from the direct link mode.  The +UUFTPCR URC notifies if the STORE operation has been concluded successfully.

### 12.1.4 About "+++" escape sequence usage

To switch from the data mode to the command mode the application shall send to the module a proper escape sequence. The application can configure the escape sequence by means of the following commands:

- AT2S: this command sets the character used as the escape character (by default it is "+")
- AT12S: this command sets the escape prompt delay ( $T_{EPD}$ ) timer (by default it is 1 s)

For more details on the AT commands, see the u-blox AT Commands Manual [1].

The escape sequence must follow certain timing constraints to be distinguished from generic data.

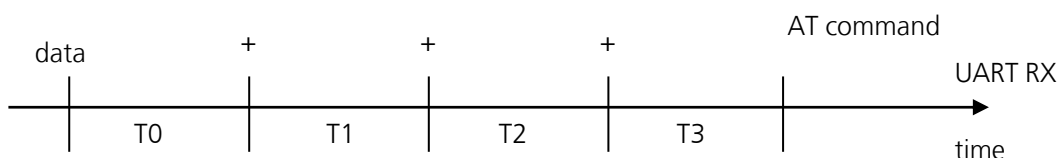

- $T_0 > T_{EPD}$ : there must be at least  $T_{EPD}$  seconds after the last data byte and the first escape character
- $T_1 < T_{EPD}$ : the second escape character must be sent within  $T_{EPD}$  seconds after the first escape character

- $T_2 < T_{EPD}$ : the third escape character must be sent within  $T_{EPD}$  seconds after the second escape character
- $T_3 > T_{EPD}$ : There must be at least  $T_{EPD}$  seconds after the last escape character and the first AT command

## 12.2 Using secure option

LISA-U2
SARA-U2
SARA-G3
SARA-G4
TOBY-L2
TOBY-R2
LARA-R2

Not supported by SARA-G3 "00" product version and TOBY-L201.

Command	Response	Description
		Parameters configuration for the FTP server connection in secure mode. These parameters are set:
AT+UFTP=0, "123.213.132.231"	OK	• FTP server address
AT+UFTP=2, "myname"	OK	• FTP username
AT+UFTP=3, "mypwd"	OK	• FTP password
AT+UFTP=8, 1	OK	• FTP SSL encryption enabled
AT+UFTPC=1		FTP login.
	OK	Connect to the server and manage the FTP connection using the +UFTPC command. Let's start connecting to the server.
	+UUFTPCR: 1, 1	The +UUFTPCR URC provides the FTP command result (the second parameter provides the result, 1 if is successfully performed).
		Some operators may not accept a secure FTP connection:
AT+UFTPC=1	OK	The URC provides the FTP command result: the second parameter is 0, an error has occurred.
	+UUFTPCR: 1, 0	
AT+UFTPER	+UFTPER: 8, 63	Retrieving of error class and code:
	OK	• Error class 8: "Wrong FTP API usage" • Error code 63: "Cannot set secure socket"

# 13 SMTP AT commands

LEON-G1
SARA-G3

Not supported by SARA-G300 / SARA-G310 modules.

Make sure to follow the steps in section 5 before using the AT commands in this section.

Command	Response	Description
AT+USMTP=1,"smtp.mail.yahoo.com"	OK	Parameter configuration for SMTP. These parameters will be set: <ul style="list-style-type: none"> <li>SMTP server hostname</li> </ul>
AT+USMTP=4,0	OK	<ul style="list-style-type: none"> <li>Authentication type (no authentication)</li> </ul>
AT+USMTP=5,3600	OK	<ul style="list-style-type: none"> <li>Inactivity timeout</li> </ul>
AT+UDNSRN=0,"smtp.mail.yahoo.com"	+UDNSRN: "69.147.102.58" OK	Hostname resolution.
AT+USMTPM	OK	Prepare the mail envelope and body <ul style="list-style-type: none"> <li>Reset all the parameters.</li> </ul>
AT+USMTPM=0,"test.sender@yahoo.com"	OK	<ul style="list-style-type: none"> <li>Set up mail sender address</li> </ul>
AT+USMTPM=1,"test.sender@yahoo.com"	OK	<ul style="list-style-type: none"> <li>Set up the reply-to mail address</li> </ul>
AT+USMTPM=2,"receiver@somedomain.com"	OK	<ul style="list-style-type: none"> <li>Set up the mail receiver address</li> </ul>
		The specified mail addresses are only examples.
AT+USMTPM=3,"This is the subject of the email"	OK	<ul style="list-style-type: none"> <li>Set up the mail subject</li> </ul>
AT+USMTPM=4,"This is the body text of the email"	OK	<ul style="list-style-type: none"> <li>Set up the mail text</li> </ul>
AT+USMTPM=5,"screenshot.jpg",2,"jpg"	OK	<ul style="list-style-type: none"> <li>Set up the attachment stored in file system.</li> </ul>
		"screenshot.jpg" is a filename for example only. Specify filenames stored into the file system.
AT+USMTPC=1	OK	Send the email. To send an email it is needed to: <ul style="list-style-type: none"> <li>Connect to the SMTP server</li> </ul>
	+UUSMTPCR: 1,1	
AT+USMTPC=2	OK	<ul style="list-style-type: none"> <li>Send the email</li> </ul>
	+UUSMTPCR: 2,1	
AT+USMTPC=0	OK	<ul style="list-style-type: none"> <li>Disconnect from the SMTP server</li> </ul>
	+UUSMTPCR: 0,1	The notification of the operation is provided by the reception of the +UUSMTPCR URC (1 means success).
AT+USMTPM	OK	Reset the mail parameters.
AT+UPSDA=0,4	OK	GPRS connection detachment with the +UPSDA AT command. The specified profile will be deactivated.





## 14 ODIS implementation

SARA-U2

TOBY-R2



LARA-R2

-  Supported by SARA-U201 / TOBY-R200 / TOBY-R202 / LARA-R202 / LARA-R203 modules only.
-  Automatic notifications are not supported by SARA-U201 "03" product versions.

u-blox cellular modules contain an OMA-DM client complying with the OMA-DM standard 1.2.1 [14] and customized for the AT&T requirements regarding ODIS (OMA-DM IMEI Sync) and FW update notification [15].

AT&T requires all radio module integrators (OEMs) to support ODIS or else to assign a unique TAC on a unique device basis, as defined in the PTCRB PPMD rules. As a manual alternative, all the devices that do not implement ODIS or are using a module that does not support ODIS must provide AT&T with a data file which maps IMEIs to host device information. This data file should be a .csv formatted text file reporting the following info: host manufacturer name, host software version, host model, IMEI and host device Plasma ID (assigned by AT&T). Data must be provided to AT&T on a recurring three-month basis beginning at the time AT&T approval is granted.

This section provides some guidelines to the users on the ODIS functionality implementation based on the module OMA-DM client.

-  It is the user's responsibility to properly configure the ODIS parameters into the cellular module according to the host device details.
-  It is recommended to populate the ODIS nodes during the host device production process. Once populated, the AT&T OMA-DM server may query the device at any time to read the content of the nodes.
-  The OMA-DM client uses the internal PDP context with pre-defined "phone" APN. The APN may be reconfigured remotely via OMA-DM protocol. The context is activated whenever needed (and deactivated when not needed) by the OMA-DM client:
  - With the +UOMADM=1 command
  - With the +UOMADMALERT command
  - When a correct OMA-DM WAP Push is received
  - Automatically (if automatic notifications are supported), when the firmware is updated or an ODIS node has been changed.



### 14.1 OMA-DM client initialization

At the module power-on, the OMA-DM functionality is automatically enabled and remains in an idle state with no communications with the OMA-DM server until one of the following events occurs:

- Network initiated: the module receives a notification (WAP push) from the OMA-DM server. This procedure is completely automatic and requires no actions from the host application processor.
- Device initiated; several scenarios are possible:
  - The module initiates automatically (if automatic notifications are supported) a connection with the OMA-DM server to notify the update the ODIS nodes or the firmware update.
  - The host devices forces a notification (alert) to be sent to the OMA-DM server, using the +UOMADMALERT AT command
  - The host devices requires an OMA-DM session to be established to the server, for instance to execute the commands which have been queued in the server. In this case the OMA-DM client must be started with the +UOMADM=1 AT command.

Command	Response	Description
AT+COPS?	+COPS: 0,0,"AT&T",2 OK	Verify the module is registered under AT&T network.
AT+CCLK="16/09/21,17:24:00+00"	OK	Set the correct date / time.
AT+UOMADM=1	OK	Initialize the OMA-DM client.  After initialization, the module will attempt to connect with the OMA-DM server if available.

It is not required to stop the connection with the OMA-DM server: the module OMA-DM client will automatically close it when all pending transactions are completed.

-  Register the module under the AT&T network to activate an OMA-DM session.
-  The module does not notify the user in case the OMA-DM connection with the server failed.

## 14.2 ODIS nodes

The OMA-DM client allows the host application processor connected to the module to configure (and store in NVM) the following properties, called ODIS nodes:



- Host Device Manufacturer
- Host Device Model
- Host Device Software Version
- Host Device Plasma ID (assigned by AT&T)

To set and read these data, the host application processor can use the +UOMADMREP AT command. The example below shows the ODIS nodes configuration assuming the host device has the following details:

- Host device manufacturer: Acme
- Host device model: Rocket1
- Host device software version: 12.34b
- Host device plasma ID: 0000-9876

Command	Response	Description
AT+UOMADM=1	OK	Initialize the OMA-DM client.
AT+UOMADMREP=1, "./DevDetail/Ext/HostMan", "Acme"	OK	Set the content of the ODIS node Host Device Manufacturer.
AT+UOMADMREP=1, "./DevDetail/Ext/HostMod", "Rocket1"	OK	Set the content of the ODIS node Host Device Model.
AT+UOMADMREP=1, "./DevDetail/Ext/HostSwV", "12.34b"	OK	Set the content of the ODIS node Host Device Software Version.
AT+UOMADMREP=1, "./DevDetail/Ext/HostPlasmaID", "0000-9876"	OK	Set the content of the ODIS node Host Device Plasma ID.
AT+UOMADMREP=0, "./DevDetail/Ext/HostMan"	+UOMADMREP: "./DevDetail/Ext/HostMan", "Acme" OK	Read the content of the ODIS node Host Device Manufacturer.
AT+UOMADMREP=0, "./DevDetail/Ext/HostMod"	+UOMADMREP: "./DevDetail/Ext/HostMod", "Rocket1" OK	Read the content of the ODIS node Host Device Model.
AT+UOMADMREP=0, "./DevDetail/Ext/HostSwV"	+UOMADMREP: "./DevDetail/Ext/HostSwV", "12.34b" OK	Read the content of the ODIS node Host Device Software Version.
AT+UOMADMREP=0, "./DevDetail/Ext/HostPlasmaID"	+UOMADMREP: "./DevDetail/Ext/HostPlasmaId", "0000-9876" OK	Read the content of the ODIS node Host Device Plasma ID.

The settings of the ODIS nodes, configured with the +UOMADMREP AT command, are saved in the module NVM at the module power-off (AT+CPWROFF, AT+CFUN=15 or AT+CFUN=16).

-  On SARA-U2 modules, initialize the OMA-DM client using the +UOMADM AT command before to issue the +UOMADMREP AT command.
-  The AT&T OMA-DM server may query these values at any time and assumes these settings are correctly specified and maintained up-to-date by the host device.
-  It is the sole responsibility of the user to properly set ODIS nodes on the module before operating under the AT&T network.

The +UOMADMREP=1 AT command only acts on the local repository of ODIS data. In case of change in the ODIS nodes:

- if automatic notifications are supported, the module attempts to notify the server
- if automatic notifications are not supported, the host device should use the following procedure.

To notify the OMA-DM server using the +UOMADMALERT AT command:

Command	Response	Description
AT+UOMADM=1	OK	Initialize the OMA-DM client.
AT+UOMADMREP=1, ". /DevDetail/Ext/HostSwV", "12.57z"	OK	The ODIS node Host Device Software Version is updated.
AT+UOMADMALERT=1, "org.openmobilealliance.dm.firmwareupdate.devicerequest", ". /DevDetail/Ext/HostSwV"	OK	The OMA-DM server is alerted that the content of the ODIS node Host Device Software Version has been changed.



## 14.3 Module FW update notification

The AT&T requirement <CDR-DVM-1533> [15] mandates that a FW update on the cellular module must be notified to the AT&T OMA-DM server.

The module FW upgrade may cause a change an update in the following nodes:

- Module FW version
- Module SW version
- International Mobile station Equipment Identity and Software Version number (IMEISV)

The host application processor has no control over the previous nodes but must notify the AT&T OMA-DM server about the changes occurred.

-  See the u-blox AT Commands Manual [1] and the Firmware Update Application Note [13] for more details about the FW update procedure of the cellular module.
-  In case of a firmware update:
  - if automatic notifications are supported, the module attempts to notify the server as soon as there is network coverage
  - if automatic notifications are not supported, the host device should use the following procedure.

After the module FW update completion, execute the following command sequence to manually notify the AT&T OMA-DM server about the changes introduced.

Command	Response	Description
AT+UOMADMALERT=1,"","org.openm obilealliance.dm.firmwareupdat e.devicerequest","./DevDetail/ FwV"	OK	Alert the OMA-DM server that the content of the node Module FW Version has been changed.
AT+UOMADMALERT=1,"","org.openm obilealliance.dm.firmwareupdat e.devicerequest","./DevDetail/ SwV"	OK	Alert the OMA-DM server that the content of the node Module SW Version has been changed.
AT+UOMADMALERT=1,"","org.openm obilealliance.dm.firmwareupdat e.devicerequest","./DevDetail/ Ext/IMEISV"	OK	Alert the OMA-DM server that the content of the node IMEISV has been changed.

## 14.4 OMA-DM client activity reporting

It is often useful to get an indication on the activity of the OMA-DM client, which can silently connect to a server for remotely-controlled operations.

The +UUOMASTAT URC can be used in this case.

Command	Response	Description
AT+UUOMASTAT=1	OK	Enabling the +UUOMASTAT URC.
	+UUOMASTAT: 1,0,0	A WAP Push triggering OMA-DM has been received, an OMA-DM session is started.
	+UUOMASTAT: 1,1,0	The OMA-DM session has completed without errors. The connection with the server is closed.  This does not imply that the ODIS nodes have been properly written or updated on the OMA-DM server.

# 15 HTTP AT commands

LEON-G1
LISA-U2
SARA-G3
SARA-G4
SARA-U2
TOBY-L2
TOBY-R2
LARA-R2

Not supported by SARA-G300 / SARA-G310 modules.

Make sure to follow the steps in section 5 before using the AT commands in this section.

Command	Response	Description
AT+CMEE=2	OK	Set verbose error result codes.
AT+UHTTP=0	OK	Reset the HTTP profile #0.
AT+UHTTP=0,1,"httpbin.org"	OK	Set the server domain name and port.
AT+UHTTP=0,5,80	OK	
AT+UDNSRN=0,"httpbin.org"	+UDNSRN: "54.72.52.58" OK	DNS resolution of httpbin.org.
AT+UHTTTPC=0,0,"/", "head.fff"	OK +UUHTTTPCR: 0,0,1	HEAD request of the default page and store the result into the "head.fff" file on the local file system of the module. The +UUHTTTPCR URC notifies the success/failure of the operation (in this example: success).
AT+UHTTTPC=0,1,"/", "get.fff"	OK +UUHTTTPCR: 0,1,1	GET request of the default page and store the result into the "get.fff" file on the local file system of the module. The +UUHTTTPCR URC notifies the success/failure of the operation (in this example: success).
AT+UHTTTPC=0,5,"/post", "post.fff", "name_post=MyName&age_post=30",0	OK +UUHTTTPCR: 0,5,1	POST request sending data using content type application/x-www-form-urlencoded. The result is saved in the "post.fff" file on the local file system of the module. The +UUHTTTPCR notifies the success/failure of the operation (in this example: success).
AT+UHTTP=0,2,"test_user"	OK	Set the authentication for the HTTP server: HTTP server username
AT+UHTTP=0,3,"P455w0rd"	OK	HTTP server password
AT+UHTTP=0,4,1	OK	HTTP server authentication method (basic authentication)
AT+UHTTTPC=0,1," /basic-auth/test_user/P455w0rd", "get_auth.fff"	OK +UUHTTTPCR: 0,1,1	The 6th character of the password is a zero. GET request returning information on authenticated user. The page requires basic authentication. The result is saved in "get_auth.fff" file on the local file system of the module. The +UUHTTTPCR URC notifies the success/failure of the operation (in this example: success).

To list and view all files stored in the cellular module file system, see the section 21.

## 15.1 Using secure option

LISA-U2
SARA-G3
SARA-G4
SARA-U2
TOBY-L2
TOBY-R2
LARA-R2

- Not supported by LISA-U2 / SARA-U2 "x2", "01" and "00" product version.
- Not supported by SARA-G3 "01" and "00" product version.
- Not supported by TOBY-L2 "01" and "00" product version.

The enabling of the SSL/TLS protocol provides a secure connection between two entities using TCP sockets for communication (i.e. HTTP/FTP server and HTTP/FTP client).

The security aspects used in the current connection depend on the SSL/TLS configuration and features supported by the communication entities on which basis it is possible to set the server authentication, the client authentication, the data security and integrity.

First of all, it is important to explain the concept of X.509 certificates and the way in which they can be imported in the module for establishing a SSL/TLS connection.

### 15.1.1 Importing a X.509 certificate

In cryptography, X.509 is an ITU-T standard that specifies the use of certificates, their structure and features.

In detail, they can be defined in the following ways:

- DER (Distinguished Encoding Rules): binary format;
- PEM (Privacy-Enhanced Mail): base 64 encoding of a DER certificate.

Consequently, different procedures can be identified in the handling of these types by +USECMNG AT command.

#### 15.1.1.1 Example 1: import a root certificate in DER format

In this case it is supposed that a DER certificate has been previously stored in the module file system by downloading it, as an example, from an FTP server by means of AT commands (see the section 12 for details). Then its actual import is carried out as follows.

Command	Response	Description
AT+CMEE=2	OK	Set the verbose error result codes.
AT+ULSTFILE=0	+ULSTFILE: "MyRootCA.der" OK	List all the files in the file system.
AT+USECMNG=1,0,"MyRootCA","MyRootCA.der"	+USECMNG: 1,0,"MyRootCA","f775ab29fb514eb7775eff053c998ef5" OK	Import a certificate in DER format from a file stored on file system and save it internally as "MyRootCA".
AT+USECMNG=3	CA,"MyRootCA","IssuerRootCA","2022/05/21 04:00:00" OK	List the imported certificates.

#### 15.1.1.2 Example 2: import a root certificate in PEM format

Now it is necessary first to obtain the root certificate in PEM format from the target website and then to import it in the module. These topics are analyzed in detail in the next sections.

##### Retrieving a root certificate

First of all connect to the desired website by browser: in the example in [Figure 23](#), the u-blox homepage is the target website.

Once the u-blox homepage is loaded in the browser, click on the lock symbol in the address bar of the browser to inspect the website certificate.

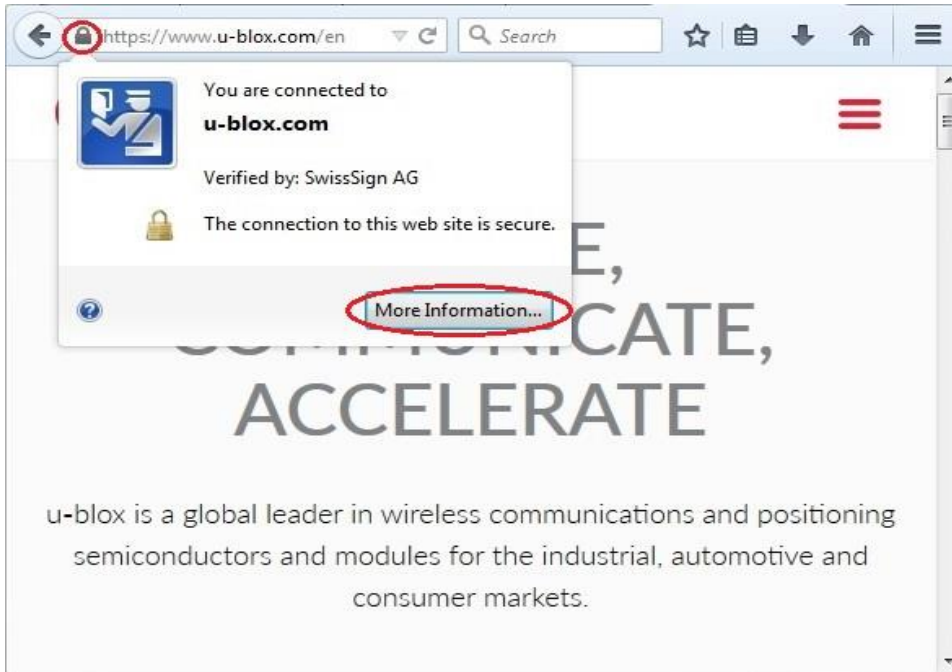

Figure 23: Click on the lock symbol of the u-blox homepage

Then push the "More Information" button to see the information related to the page.

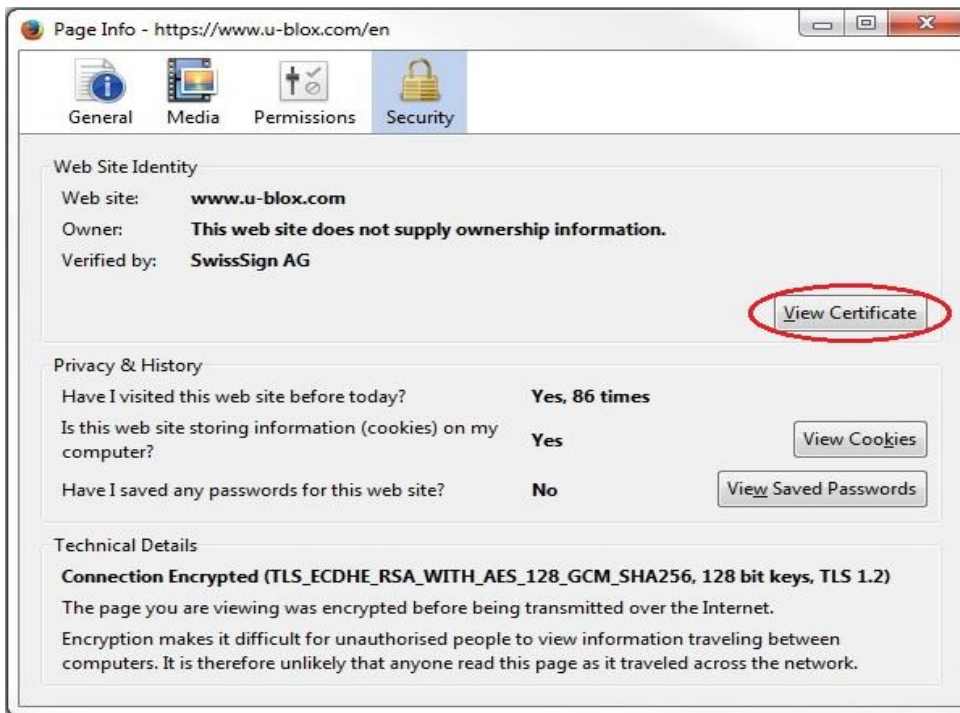

Figure 24: u-blox page information

Next select the "View Certificate" button.

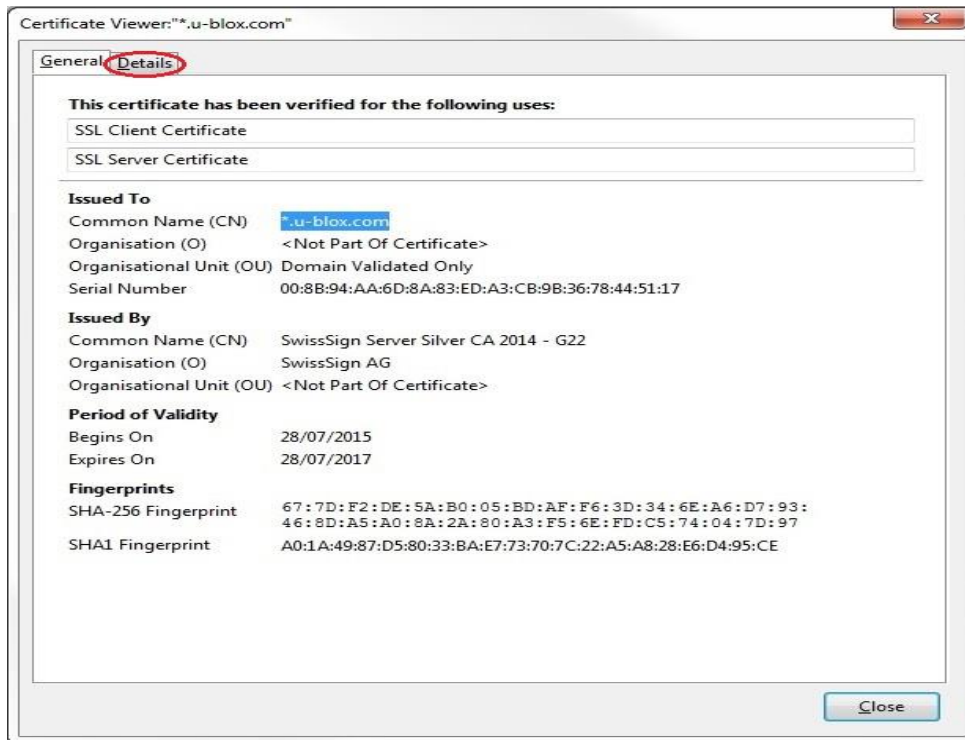

Figure 25: u-blox certificate

Select the "Details" tab to retrieve more information.

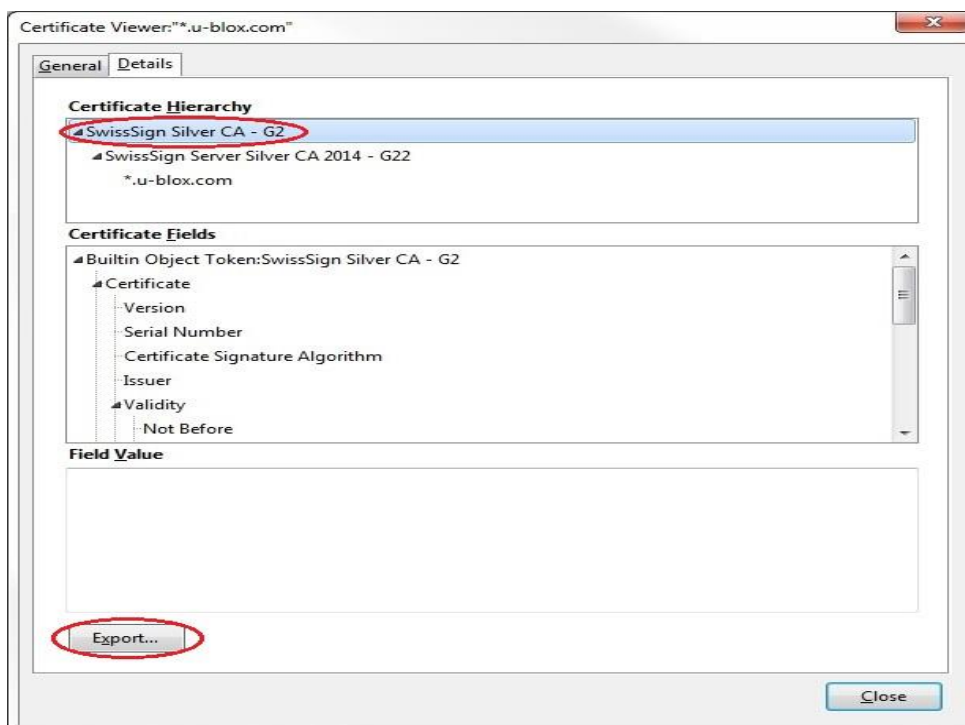

Figure 26: Details about the u-blox certificate

On the details screen, first select the "SwissSign Silver CA - G2" item and then click the "Export" button to locally save the u-blox certificate in PEM format, by choosing a \*.crt filename extension.

Later the u-blox certificate can be viewed with a common text editor as follows.



```

u-blox_SwissSignSilverCA-G2.crt
1 -----BEGIN CERTIFICATE-----CRLE
2 MIIFvTCCA6WgAwIBAgIITxvUL1S7L0swDQYJKoZIhvcNAQEFBQAwRzELMAkGA1UECRLE
3 BhMCQ0gxFTATBgNVBAoTDFN3aXNzU2lnbiBBRzEhMB8GA1UEAxMYU3dpc3NTaWduCRLE
4 IFNpbHZ1ciBDQSAIEcyMB4XDTA2MTAyNTA4MzI0N1oXDTM2MTAyNTA4MzI0N1owCRLE
5 RzELMAkGA1UEBhMCQ0gxFTATBgNVBAoTDFN3aXNzU2lnbiBBRzEhMB8GA1UEAxMYU3dpc3NTaWduCRLE
6 U3dpc3NTaWduIFNpbHZ1ciBDQSAIEcyMIIICjANBgkqhkiG9w0BAQEFAAOCAg8AQRLE
7 MIIICCgKCAgEAXPGHf9N4Mfc4yfjDmUO8x/e8N+dOcbpLj6VzHVxumK4DV644N0MvCRLE
8 Fz0fyM5oEMF4rhkDKx6LHmD9ui5aL1V8gREpzn5/ASLHVGiTSf5YXu6t+WiE7brCRLE
9 YT7QbNHm+/pe7R20nqA1W6GSy/BJkv6FCgU+5tkL4k+73JU3/JHpMjUi0R86TieFCRLE
10 nbAV1DLaYQ1HTWBCrpJH6INaUFjpiou5XaHc3Z1KHZnu0jkg7Y360g6rw9njxcHCRLE
11 6ATK72oxh9TatvmUcXtnZLi2kUpCe2UuMGoM9ZDulebyzYLS2aFK7PayS+VFheZtCRLE
12 eJMElpYCbTApXDFkH4aDCyr0Nqp4yVXPQbBH6TCfmb5hqAaEuSh6XzjZG6k4sIN/CRLE
13 c8HDO0gqgg8hm7jMqDXDhBuDs6+pJVpATqJAHgE2cn0mRmrVn5bi4Y5FZGkECWJCRLE
14 MoBgs5PAKrYYC51+jUnyEEp/+dVGLxmSo5mnJqy7jDzmDrxHB9xzUfFwZC8I+bRHCRLE
15 HTBsrOopN4WSaGa8gzj+ezku01DwH/teYLappvonQfGhGhLY9YR0SslnxFSuSGTfCRLE
16 jNFusB3hB48IHpmccelM2KX3RxIfdNFRnobzwljQAtz20um53MGjMGg6cFZrEb6CRLE
17 5i/4z3GcRm25xBNNOhkDRUjvxF3XCO6HOSKGSg0PWEp3calILv3q1h8CAwEAAaOBQRLE
18 rDCBqTAOBgNVHQ8BAf8EBAMCAQYwDwYDVR0TAQH/BAUwAwEB/zAdBgNVHQ4EFgQUQRLE
19 F6DNweRbtjpb08tFnb0cwpj6hlgwHwYDVR0jBBgwFoAUF6DNweRbtjpb08tFnb0cQRLE
20 wpj6hlgwRgYDVR0gBD8wPTA7Bg1ghXQBWQEDAQEwLjAsBggrBgEFBQcCARygaHR0QRLE
21 cDovL3JlcG9zaXRvcnkuc3dpc3NzaWduLmNvbS88wDQYJKoZIhvcNAQEFBQADggIBQRLE
22 AHPGgeAn0i0P4JUw4ppBf1AsX19iYamGamkYDHRJ112E6kFSGG9YrVBWIGrGvShpQRLE
23 WJHckRE1qTodvBq1YJ7YH39FkwnZftr4csEGDyrOj4VwYaygzQu4OS1WhDJOhrs9QRLE
24 xCrZ1x9y7v5RoSJBsXECYxqCsGKrX1cSH9/L3XWgwF15kIwb4FDm3jH+mHtwX6WQQRLE
25 2K34ArZv02DdQEsixT2tOnqfGhpHkXkzuoLcMmkDlm4fS/Bx/uNncqCvx1yL5Pq2QRLE
26 IseEuRuNI5c/7SXgz2W79WEE790eslpBI1ghn10s6FvJbakMDHiqYMZwjwFaDGisQRLE
27 ar15xB9+lwW/xekkuUV7U1UtT7dkjWjYDZaPBA61BMPNGG4WQr2W11bHkFlt4dR2XQRLE
28 em1zqSqpE97Dh4kQmUlzeMg9vVE1dCrV8X5pGyq70701uJpaPXJhkGaH7gzWTdQRQRLE
29 dAtq/gSD/KNVV4n+SsuWxcFyPKNIzFTONItaj+CuY0IavdeQXRuwxF+B6wpYJE/QRLE
30 OMPXEA29MC/HpeZBoNquBYeaoKR1bEwJDIm6uN05wJOKMPqN5ZprFQFOZ6raY1Y+QRLE
31 hAhm0sQ2fac+EPyI4NSA5QC9qvNOBqN6avlicuMJT+ubDgEj8Z+7fNZcbBGXJbLyQRLE
32 tGMU0gYqZ4yD9c7qB9iaah7s5Aq7KkzrCWA5zspi2C5uQRLE
33 -----END CERTIFICATE-----CRLE
34
length: 2082 Ln: 34 Col: 1 Sel: 0|0 Dos:\Windows UTF-8 w/o BOM INS
    
```

Figure 27: u-blox certificate in PEM format

At this point the user is able to import the reported certificate in the module by a copy and paste operation when the suitable AT command is issued as described in detail in the next section.

### Handling a root certificate

Now the user holds a \*.crt file containing the u-blox certificate in PEM format so he is able to carry out the import procedure as follows.

Command	Response	Description
AT+CMEE=2	OK	Set the verbose error result codes.
AT+USECMNG=0,0,"u-bloxCA",2082 >	>	Start the data transfer using the stream of byte (in this case 2082 is the size in bytes of the certificate).
PEM encoded trusted root certificate data	+USECMNG: 0,0,"u-bloxCA","e006a1c97dcfc9fc0dc0567596d86213" OK	Input PEM formatted trusted root certificate data bytes. Output MD5 hash string of the stored trusted root certificate DER.
AT+USECMNG=3	CA,"u-bloxCA","SwissSign Silver CA - G2","2036/10/25 08:32:46" OK	List the imported certificates.

## 15.1.2 Examples about certificate validation levels

As already mentioned, the security aspects used in a connection depend on the SSL/TLS configuration and features supported by the communication entities. In this context the +USECPRF AT command configures the secure option.

For this purpose, the following examples describe the configuration and the establishment of some SSL/TLS connections, in which different security profile settings are used.

### 15.1.2.1 Example 1: +USECPRF with no certificate validation (level 0)

In the security profile 0, which is the default one, no certificate validation is set (level 0). This means the target server certificate will not be checked or verified and no additional certificates need to be imported in the module.

Command	Response	Description
AT+CMEE=2	OK	Set the verbose error result codes.
		Parameters configuration for the SSL/TLS connection. The following commands are issued:
AT+USECMNG=3	OK	<ul style="list-style-type: none"> <li>List the imported certificates: in this case no additional certificates are necessary to be available in the module.</li> </ul>
		Parameters configuration for the HTTP server connection in secure mode. The following commands are issued:
AT+UHTTP=0	OK	<ul style="list-style-type: none"> <li>reset the HTTP profile 0</li> </ul>
AT+UHTTP=0,1,"www.my_test_server.com"	OK	<ul style="list-style-type: none"> <li>set the HTTP server name</li> </ul>
AT+UHTTP=0,6,1,0	OK	<ul style="list-style-type: none"> <li>enable the secure option for the HTTP service using the security profile 0 (the default one)</li> </ul>
		To test the secure option, a HEAD command can be sent to the reference server.
AT+UHTTPC=0,0,"/httpstest/",""	OK	
	+UUHTTPCR: 0,0,1	 The HTTP command result is provided through the +UUHTTPCR URC (the last parameter provides the result, 1 if is successfully performed).
		Some operators or servers may not support the secure HTTP service.
	+UUHTTPCR: 0,0,0	The HTTP command result URC: the last parameter is 0, an error occurred.
AT+UHTTPER=0	+UHTTPER: 0,3,11 OK	<ul style="list-style-type: none"> <li>Error class 3: HTTP protocol error class</li> <li>Error code 11: server connection error</li> </ul>

### 15.1.2.2 Example 2: +USECPRF with certificate validation (level 1)

The security profile 2 with a certificate validation set (level 1) means that the target server certificate will be checked against a list of trusted root certificates previously imported in the module.

Command	Response	Description
AT+CMEE=2	OK	Set the verbose error result codes.
		Parameters configuration for the SSL/TLS connection. The following commands are issued:
AT+USECMNG=3	CA,"MyTestSvrCA","IssuerMyTestSvrCA","2022/05/21 04:00:00"	<ul style="list-style-type: none"> <li>list imported certificates;</li> </ul>

Command	Response	Description
	OK	
AT+USECPRF=2	OK	<ul style="list-style-type: none"> <li>reset security profile 2;</li> </ul>
AT+USECPRF=2,0,1	OK	<ul style="list-style-type: none"> <li>set level 1 validation for security profile 2.</li> </ul>
		Parameters configuration for the HTTP server connection in secure mode. The following commands are issued:
AT+UHTTP=0	OK	<ul style="list-style-type: none"> <li>Reset the HTTP profile 0;</li> </ul>
AT+UHTTP=0,1,"www.my_test_server.com"	OK	<ul style="list-style-type: none"> <li>Set the HTTP server name;</li> </ul>
AT+UHTTP=0,6,1,2	OK	<ul style="list-style-type: none"> <li>Enable the secure option for the HTTP service using the security profile 2.</li> </ul>
		To test the secure option, a HEAD command can be sent to the reference server.
AT+UHTTTPC=0,0,"/httpptest/", ""	OK	
	+UUHTTTPCR: 0,0,1	 The HTTP command result is provided by means of +UUHTTTPCR URC (the last parameter provides the result, 1 if is successfully performed).
		Some operators or servers may not support the secure HTTP service.
	+UUHTTTPCR: 0,0,0	HTTP command result URC: the last parameter is 0, an error occurred.
AT+UHTTTPER=0	+UHTTTPER: 0,3,11 OK	Retrieving of error class (3 = HTTP Protocol error class) and code (11 = Server connection error).

### 15.1.2.3 Example 3: +USECPRF with certificate validation (level 2)

The security profile 2 with a certificate validation set (level 2) is the level 1 validation with an additional URL integrity check. The target server certificate will be verified against a list of trusted root certificates previously imported in the module with an additional URL integrity check about the expected server hostname.

Command	Response	Description
AT+CMEE=2	OK	Set the verbose error result codes.
		Parameters configuration for the SSL/TLS connection. The following commands are issued:
AT+USECMNG=3	CA,"MyTestSvrCA","IssuerMyTestSvrCA","2022/05/21 04:00:00" OK	<ul style="list-style-type: none"> <li>list imported certificates;</li> </ul>
AT+USECPRF=2	OK	<ul style="list-style-type: none"> <li>Reset the security profile 2;</li> </ul>
AT+USECPRF=2,0,2	OK	<ul style="list-style-type: none"> <li>Set level 2 validation for security profile 2;</li> </ul>
AT+USECPRF=2,4,"www.my_test_server.com"	OK	<ul style="list-style-type: none"> <li>Set the server hostname for security profile 2.</li> </ul>
		Parameters configuration for the HTTP server connection in secure mode. The following commands are issued:
AT+UHTTP=0	OK	<ul style="list-style-type: none"> <li>Reset the HTTP profile 0;</li> </ul>
AT+UHTTP=0,1,"www.my_test_server.com"	OK	<ul style="list-style-type: none"> <li>Set the HTTP server name;</li> </ul>
AT+UHTTP=0,6,1,2	OK	<ul style="list-style-type: none"> <li>Enable the secure option for the HTTP service using the security profile 2.</li> </ul>
		To test the secure option, a HEAD command can be sent to the reference server.
AT+UHTTTPC=0,0,"/httpptest/", ""	OK	
	+UUHTTTPCR: 0,0,1	 The HTTP command result is provided by means of the +UUHTTTPCR URC (the last

Command	Response	Description
		parameter provides the result, 1 if is successfully performed).
		Some operators or servers may not support the secure HTTP service.
	+UUHTTPCR: 0,0,0	The HTTP command result URC: the last parameter is 0, an error occurred.
AT+UHTTTPER=0	+UHTTTPER: 0,3,11 OK	Retrieving of error class (3 = HTTP Protocol error class) and code (11 = Server connection error).

#### 15.1.2.4 Example 4: +USECPRF with certificate validation (level 3)

The security profile 2 with a certificate validation set (level 3) is the level 2 validation with an additional check about the certificate validity date. The target server certificate will be verified against a list of trusted root certificates previously imported in the module with additional checks regarding the expected server hostname and the certificate validity date.

Command	Response	Description
AT+CMEE=2	OK	Set the verbose error result codes.
AT+CCLK?	+CCLK: "15/11/18,12:30:50+01" OK	Check the real-time clock of the module and, if necessary, set the current time.
		Parameters configuration for the SSL/TLS connection. The following commands are issued:
AT+USECMNG=3	CA, "MyTestSvrCA", "IssuerMyTestSvrCA", "2022/05/21 04:00:00" OK	<ul style="list-style-type: none"> <li>List the imported certificates;</li> </ul>
AT+USECPRF=2	OK	<ul style="list-style-type: none"> <li>Reset the security profile 2;</li> </ul>
AT+USECPRF=2,0,3	OK	<ul style="list-style-type: none"> <li>Set level 3 validation for security profile 2;</li> </ul>
AT+USECPRF=2,4,"www.my_test_server.com"	OK	<ul style="list-style-type: none"> <li>Set the server hostname for security profile 2.</li> </ul>
		Parameters configuration for the HTTP server connection in secure mode. The following commands are issued:
AT+UHTTTP=0	OK	<ul style="list-style-type: none"> <li>Reset the HTTP profile 0;</li> </ul>
AT+UHTTTP=0,1,"www.my_test_server.com"	OK	<ul style="list-style-type: none"> <li>Set the HTTP server name;</li> </ul>
AT+UHTTTP=0,6,1,2	OK	<ul style="list-style-type: none"> <li>Enable the secure option for the HTTP service using the security profile 2.</li> </ul>
		To test the secure option, a HEAD command can be sent to the reference server.
AT+UHTTTPC=0,0,"/httpptest/", ""	OK	
	+UUHTTTPCR: 0,0,1	 The HTTP command result is provided by means of the +UUHTTTPCR URC (the last parameter provides the result, 1 if is successfully performed).
		Some operators or servers may not support the secure HTTP service.
	+UUHTTTPCR: 0,0,0	The HTTP command result URC: the last parameter is 0, an error occurred.
AT+UHTTTPER=0	+UHTTTPER: 0,3,11 OK	Retrieving of error class (3 = HTTP Protocol error class) and code (11 = Server connection error).

### 15.1.3 Data security and integrity

An SSL/TLS connection is characterized by its own configuration and features to guarantee specific aspects of the data security and integrity that is data encryption and Hash Message Authentication (HMAC) generation for checking exchanged messages.

This behavior is closely related to the concept of cipher suites: in fact they represent a named combination of protocol version, authentication and key exchange, encryption and message authentication code algorithms.

In simple terms, ciphers suits are used to specify supported and negotiate SSL/TLS connection properties and algorithms. They are usually identified by a string like the following:

TLS\_RSA\_WITH\_AES\_256\_CBC\_SHA256

the meaning of which is as follows:

- TLS protocol is used in communication;
- RSA algorithm is utilized for authentication and secure key exchange;
- AES\_256\_CBC is considered for encryption of transmitted data;
- SHA256 algorithm is adopted for creating HMAC message integrity code.

See the u-blox AT Commands Manual [1] for the list of all the supported cipher suites, while in the next section is presented an explanation of how to configure the behavior in exam.

#### 15.1.3.1 Example: cipher suite management in SSL/TLS connections

In this context the +USECPRF AT command configures the secure options: in fact it allows the user to choose the cipher suite to be applied in the communication.

 The SSL/TLS connection is not established and an error result code is provided if a cipher suite not supported by the target server is selected.

Command	Response	Description
AT+CMEE=2	OK	Set the verbose error result codes.
AT+USECMNG=3	OK	Parameters configuration for the SSL/TLS connection. The following commands are issued: <ul style="list-style-type: none"> <li>• List the imported certificates;</li> <li>• Reset the security profile 2;</li> <li>• Set the cipher suite number 4, that is TLS_RSA_WITH_AES_256_CBC_SHA256, for security profile 2.</li> </ul>
AT+USECPRF=2	OK	
AT+USECPRF=2, 2, 4	OK	
AT+UHHTTP=0	OK	Parameters configuration for the HTTP server connection in secure mode. The following commands are issued: <ul style="list-style-type: none"> <li>• Reset the HTTP profile 0;</li> <li>• Set the HTTP server name;</li> <li>• Enable the secure option for the HTTP service using the security profile 2.</li> </ul>
AT+UHHTTP=0,1,"www.my_test_server.com"	OK	
AT+UHHTTP=0,6,1,2	OK	
AT+UHHTPC=0,0,"/httpstest/", ""	OK	To test the secure option, a HEAD command can be sent to the reference server.
	+UUHTTPCR: 0,0,1	The HTTP command result by +UUHTTPCR URC: in this case the HEAD request is successfully performed.

## 15.2 HTTP POST

LEON-G1

LISA-U2

SARA-G3

SARA-G4

SARA-U2

TOBY-L2

TOBY-R2

LARA-R2



Not supported by SARA-G300 / SARA-G310 modules.

Command	Response	Description
AT+CMEE=2	OK	Set the verbose error result codes.
AT+UPSD=0,1,"click"	OK	Set the APN.
AT+UPSDA=0,3	OK	GPRS attach.
AT+UPSND=0,0	+UPSND: 0,0,"10.130.31.65" OK	Check whether the IP address is assigned.
AT+UDWNFILE="postdata.txt",11	>hello world OK	Write some data in the file to send.
AT+URDFILE="postdata.txt"	+URDFILE: postdata.txt,11,"hello world" OK	Optionally check whether the data is present.
AT+UHTTP=0	OK	Reset the HTTP profile #0.
AT+UHTTP=0,1,"httpbin.org"	OK	Set up a connection to an echo server (httpbin.org) that checks and echoes post commands.
AT+UHTTP=0,5,80	OK	Set the port of the HTTP request to 80
AT+UHTTPC=0,4,"/post","result.txt","postdata.txt",1	OK	Submit a post command in text format and store the answer in result.txt.
	+UUHTTPCR: 0,4,1	
AT+URDFILE="result.txt"	+URDFILE: result.txt,498, "HTTP/1.1 200 OK Content-Type: application/json Date: Tue, 15 Jan 2013 16:06:11 GMT Server: gunicorn/0.16.1 Content-Length: 345 Connection: Close  { "headers": { "Content-Length": "11", "Host": "httpbin.org", "Content-Type": "text/plain", "User-Agent": "UBlox Leon G200/1.0 (N7/HTTP 1.0)", "Connection": "keep-alive" }, "args": {}, "data": "hello world", "url": "http://httpbin.org/post", "files": {}, "json": null, "form": {}, "origin": "10.82.21.198" }" OK"	Check the server's reply.

## 15.3 HTTP cookies

LISA-U2

SARA-G3

SARA-G4

SARA-U2

TOBY-L2

TOBY-R2

LARA-R2

 See the u-blox AT Commands Manual [\[1\]](#) for the AT commands applicability.

Command	Response	Description
AT+CMEE=2	OK	Set the verbose error result codes.
AT+UPSD=0,1,"click"	OK	Set the APN. The APN name relates to the network operator. The one used here is only an example.
AT+UPSDA=0,3	OK	Activate a PDP context.
AT+UPSND=0,0	+UPSND: 0,0,"10.130.31.65" OK	Check whether the IP is assigned. The reported IP address is assigned by the network operator, the one used here is only an example.
AT+UHTTP=0	OK	Set up a connection to an echo server (httpbin.org) that checks and echoes post commands.
AT+UHTTPAC=0,0,0,"CKE:SIMPLE"	OK	Set a simple COOKIE.
AT+UHTTPAC=0,0,0	+UHTTPAC: 0,0,0,"CKE:SIMPLE" OK	Read the set COOKIE. This step is not mandatory.
AT+UHTTP=0,1,"httpbin.org"	OK	Set the server host name ( <b>httpbin.org is a freely available 3<sup>rd</sup> party service. It is not managed or operated by u-blox.</b> )
AT+UHTTP=0,5,80	OK	Set the server post.
AT+UHTTPC=0,1,"/get","get.ffs"	OK	Submit a GET command and store the answer in the local file get.ffs on the module file system.
	+UUHTTPCR: 0,1,1	The +UUHTTPCR URC indicates the request was successful.
AT+URDFILE="get.ffs"	OK	Read the get.ffs file.
	+URDFILE: "get.ffs",418,"HTTP/1.1 200 OK Server: nginx Date: Fri, 04 Sep 2015 14:37:07 GMT Content-Type: application/json Content-Length: 203 Connection: close Access-Control-Allow-Origin: * Access-Control-Allow-Credentials: true  { "args": {}, "headers": { "Cookie": "CKE:SIMPLE", "Host": "httpbin.org", "User-Agent": "UBLOX-HttpClient V2.0" }, "origin": "151.82.163.82", "url": "http://httpbin.org/get" }	Content of the get.ffs file where it is possible to see that the server received the cookie (line marked in red).
	OK	

# 16 Network jamming detection AT commands

LEON-G1

LISA-U2

SARA-G3

SARA-U2

 Not supported by SARA-G300 / SARA-G310 modules.

The Jamming Detection feature consists in detecting, at radio resource level, an anomalous source of interference and in signaling it to the client/DTE.

u-blox cellular modules support two different variants of this feature. In fact, it is possible to enable a “legacy version” of the Jamming Detection or an advanced feature, namely “Advanced Jamming Detection”.

The legacy version of the Jamming Detection is enabled when the following two conditions occur at the same time:

- the MS enters out of coverage (i.e. no suitable cell of any PLMN visible);
- a lot of GSM/UMTS carriers is detected, having high power levels but no sync information to be decoded on them.

The advanced jamming detection handles an additional parameter, namely “desired PLMN”. Thus, the +UCD URC will be reported only if the MS loses coverage of the specified PLMN.

The use of the legacy version rather than the advanced version depends on the particular use-case and application’s requirements.

E.g., if no communication at all needs to be done in case of jamming detection (e.g. the reaction would be an acoustic alarm) the legacy version could be a reasonable choice.

If emergency calls can be triggered in case of jamming detection, the advanced jamming detection would be more useful because, when the module loses the desired PLMN it was registered on, it might camp on a forbidden PLMN where an emergency call can be executed.

It is strongly suggested to use the network registration URC (+CREG) along the network jamming detection URC (+UCD) to evaluate the jamming condition.

It is possible to have multiple network registration URCS (+CREG) due to transitory states during cell/PLMN search and registration.

## 16.1 Jamming detection threshold and number of carriers evaluation

To set a proper threshold for jamming detection it is suggested to use:

- +CSQ and/or +CGED to evaluate the serving cell RSSI or RXLEV
- +COPS=5 and +CGED to evaluate the surrounding cells RXLEV

To set a proper number of carriers for jamming detection it is suggested to use +COPS=5 and +CGED.

In case of mobility applications, the evaluation for a proper threshold and number of carriers shall be periodical.



### 16.1.1 Example 1: 2G threshold and number of carriers evaluation

Command	Response	Description
AT+COPS=5	MCC:222, MNC:88, LAC:55fa, CI:1281, BSIC:3f, Arfcn:00102, RxLev:025 MCC:222, MNC:88, LAC:55fa, CI:1298, BSIC:02, Arfcn:00107, RxLev:020 ... MCC:222, MNC:10, LAC:4e5c, CI:ffff, BSIC:36, Arfcn:00081, RxLev:004 OK	32 BCCH carriers, not part of the serving cell's BA list, have been reported.
AT+CGED=5	+CGED: Service Cell: MCC:222, MNC: 1, LAC:d5bd, CI:5265, BSIC:15, Arfcn:01004, RxLev:030, Arfcn_ded:INVALID_ARFCN, RxLevSub:255,t_adv:000 Neighbour Cell 1: MCC:222, MNC: 1, LAC:d5bd, CI:5251, BSIC:14, Arfcn:00015, RxLev:014, ... Neighbour Cell 15: MCC:65535, MNC:255, LAC:ffff, CI:ffff, BSIC:ff, Arfcn:01022, RxLev:000, OK	Serving cell and 4 BCCH carriers, part of the serving cell's BA list, have been reported.
AT+CSQ	+CSQ: 16,99 OK	Serving cell's <rssi> is 16.
AT+CREG=1	OK	Enable the network registration URC.
AT+UCD=1,46,28	OK	<ul style="list-style-type: none"> <li>&lt;min_number_of_2G_carriers&gt; = number of BCCH carriers not part of the BA list + number of BCCH carriers part of the BA list + user defined margin (e.g. 10).</li> <li>&lt;rxlev_threshold&gt; = serving cell's RXLEV - user defined margin (e.g. 2).</li> </ul>

## 16.2 Jamming detection in 2G network

LEON-G1
LISA-U2
SARA-G3
SARA-U2

Not supported by SARA-G300 / SARA-G310 modules.

### 16.2.1 Example 1: all the available 2G carriers jammed

Command	Response	Description
AT+CMEE=2	OK	Set the verbose error result codes.
AT+CREG=1	OK	Enable the network registration URC.
AT+UCD=1,12,18	OK	2G network jamming detection enabled and configured.
	+CREG: 2	Not registered, but the module is currently searching a PLMN to register to.
	+UCD: 1	If the jamming is detected (depends on the +UCD configuration) a URC is raised.

## 16.3 Jamming detection in 3G network

LISA-U2

SARA-U2

### 16.3.1 Example 1: all the available 3G carriers jammed

Command	Response	Description
AT+CMEE=2	OK	Set the verbose error result codes.
AT+CREG=1	OK	Enable the network registration URC.
AT+UCD=3,,10,25	OK	3G network jamming detection enabled and configured.
	+CREG: 2	Not registered, but the module is currently searching a PLMN to register to.
	+UCD: 3	If the jamming is detected (depends on the +UCD configuration) a URC is raised.
	+UCD: 2	If jamming is not detected anymore or synchronization on the selected PLMN has been successful a URC is raised.
	+CREG: 1 (or +CREG:5)	Registered on home or roaming PLMN (if the registration is successful)

## 16.4 Jamming detection in 2G/3G network

LISA-U2

SARA-U2

### 16.4.1 Example 1: all the available 2G and 3G carriers jammed

Command	Response	Description
AT+CMEE=2	OK	Set the verbose error result codes.
AT+CREG=1	OK	Enable the network registration URC.
AT+UCD=4,12,18,10,25	OK	2G and 3G network jamming detection enabled and configured.
	+CREG: 2	Not registered, but the module is currently searching a PLMN to register to.
	+UCD: 1	If jamming is detected (depends on the +UCD configuration) a URC is raised.
	+UCD: 3	If jamming is detected (depends on the +UCD configuration) a URC is raised.



The 2G jamming indication URC and 3G jamming indication URC order can be inverted.

## 16.5 Advanced jamming detection in 2G network

LEON-G1
SARA-G3
SARA-U2

Not supported by LEON-G1 / LEON-G2 "07" and previous versions.

Not supported by SARA-G300 / SARA-G310 modules.

### 16.5.1 Case 1: all the available 2G carriers jammed

Command	Response	Description
AT+CMEE=2	OK	Set the verbose error result codes.
AT+CREG=1	OK	Enable the network registration URC.
AT+UCD=5, 30, 35	OK	2G network advanced jamming detection enabled and configured. The selected PLMN is retrieved from the IMSI.
	+CREG: 2	Not registered, but the module is currently searching a PLMN to register to.
	+UCD: 1	If the jamming is detected (depends on the +UCD configuration) and synchronization on the selected PLMN is not possible, a URC is raised.
	+UCD: 0	If the jamming is not detected anymore (e.g. jamming source switched off) or the synchronization on the selected PLMN has been successful (e.g. a selected PLMN's BCCH carrier stronger than the jamming source has been found), a URC is raised.
	+CREG: 1 (or +CREG:5)	Registered on home or roaming PLMN (if the registration is successful).

### 16.5.2 Case 2: all the available 2G carriers jammed; selected PLMN not retrieved from IMSI

Command	Response	Description
AT+CMEE=2	OK	Set the verbose error result codes.
AT+CREG=1	OK	Enable the network registration URC.
AT+COPS=1, 2, "00115"	OK	Manual network selection on the selected PLMN.
	+CREG: 5	The module is registered on the roaming PLMN 001/15.
AT+UCD=5, 30, 35	OK	2G network advanced jamming detection enabled and configured. The selected PLMN is retrieved from the manual network selection.
AT+COPS=0	OK	Switch to automatic network selection (mandatory step).
	+CREG: 2	Not registered, but the module is currently searching a PLMN to register to.
	+UCD: 1	If the jamming is detected (depends on the +UCD configuration) and the synchronization on the selected PLMN is not possible, a URC is raised.
	+UCD: 0	If the jamming is not detected anymore (e.g. jamming source switched off) or the synchronization on the selected PLMN has been successful (e.g. a selected PLMN's BCCH carrier stronger than the jamming source has been found), a URC is raised.
	+CREG: 1 or +CREG:5	Registered on home or roaming PLMN (if the registration is successful).

### 16.5.3 Case 3: not jammed 2G carrier(s) are not part of the selected PLMN

Command	Response	Description
AT+CMEE=2	OK	Set the verbose error result codes.
AT+CREG=1	OK	Enable the network registration URC.
AT+COFS=0	OK	Automatic network selection.
AT+UCD=5, 30, 35	OK	2G network advanced jamming detection enabled and configured. The selected PLMN is retrieved from the IMSI.
	+CREG: 2	Not registered, but the module is currently searching a PLMN to register to.
	+UCD: 1	If jamming is detected (depends on the +UCD configuration) and synchronization on the selected PLMN is not possible a URC is raised.
	+CREG: 5	The module is registered on roaming PLMN/network.
	+UCD: 0	If the jamming is not detected anymore (e.g. jamming source switched off) or the synchronization on the selected PLMN has been successful (e.g. a selected PLMN's BCCH carrier stronger than the jamming source has been found) a URC is raised.

## 17 Cell lock AT commands

- Not supported by LEON-G1 / LEON-G2 "07" and previous versions.
- Not supported by LISA-U1 series and by LISA-U2 "01" module versions.
- Not supported by TOBY-L2 "00", "01" and "60" product versions.

### 17.1 Cell lock in single mode

#### 17.1.1 Cell lock in 2G network: normal mode

LEON-G1
SARA-G3
LISA-U2
SARA-U2
TOBY-L2

- Not supported by SARA-G300 / SARA-G310 modules.

Command	Response	Description
AT+COPS=2	OK	Deregister the module prior to the lock.
AT+UCELLLOCK=3,100,0	OK	A normal cell lock is set on ARFCN 100 enabling the URC.
AT+COPS=0	OK	Set the automatic network selection.
	+UCELLLOCK: 1	If the URC mode is enabled then the cell lock state will be reported. In normal mode the module performs handovers during the connected mode. If a handover is performed or if the locking cell is lost the state will accordingly change.
AT+COPS=2	OK	Deregister the module prior disabling the lock.
AT+UCELLLOCK=0	OK	Disable the cell lock.

#### 17.1.2 Cell lock in 2G network: extended mode

LEON-G1
SARA-G3
LISA-U2
SARA-U2
TOBY-L2

- Not supported by SARA-G300 / SARA-G310 modules.

Command	Response	Description
AT+COPS=2	OK	Deregister the module prior to the lock.
AT+UCELLLOCK=5,600,1	OK	A normal cell lock is issued on ARFCN 600 of band 1900 with URC enabled.
AT+COPS=0	OK	Set the automatic network selection.
	+UCELLLOCK: 1	If the URC mode is enabled then the cell lock state will be reported. In extended mode the module does not perform any handover during the connected mode. A change of serving cell is still possible. If the service cell is changed or if the locking cell is lost the state will change accordingly.
AT+COPS=2	OK	Deregister the module prior disabling the lock.
AT+UCELLLOCK=0	OK	Disable the cell lock.

### 17.1.3 Cell lock in 2G network: normal mode

Command	Response	Description
AT+CMEE=2	OK	Set the verbose error result codes.
AT+COPS=2	OK	Deregister the module prior the lock.
AT+URAT=0	OK	Set the GSM RAT.
AT+UCELLLOCK=3,100,0	OK	A normal cell lock is set on ARFCN 100 enabling the URC.
AT+COPS=0	OK	Set the automatic network selection.
	+UCELLLOCK: 1,1	If the URC mode is enabled then the cell lock state will be reported. In normal mode the module performs handovers if in a connection. The state will accordingly change due to a handover or to the locking cell loss.
AT+UCELLLOCK=0	OK	The cell lock is disabled.

### 17.1.4 Cell lock in 2G network: extended mode

Command	Response	Description
AT+CMEE=2	OK	Set the verbose error result codes.
AT+COPS=2	OK	Deregister the module prior the lock.
AT+URAT=0	OK	Set the GSM RAT.
AT+UCELLLOCK=5,600,1	OK	An extended cell lock is issued on ARFCN 600 of band 1900 with URC enabled.
AT+COPS=0	OK	Set the automatic network selection.
	+UCELLLOCK: 1,1	If the URC mode is enabled then the cell lock state will be reported. In extended mode the module does not perform any handover if in a connection. A change of serving cell is still possible. The state will change accordingly due to a serving cell change or to the locking cell loss.
AT+UCELLLOCK=0	OK	The cell lock is disabled.

### 17.1.5 Cell lock in 3G network: normal mode

Command	Response	Description
AT+CMEE=2	OK	Set the verbose error result codes.
AT+COPS=2	OK	Deregister the module prior the lock.
AT+URAT=2	OK	Set the UMTS RAT.
AT+UCELLLOCK=3,,10838,6	OK	A normal cell lock is set on UARFCN 10838, PSC 6 enabling the URC.
AT+COPS=0	OK	Set the automatic network selection.
	+UCELLLOCK: 1,2	If the URC mode is enabled then the cell lock state will be reported. In normal mode the module performs soft/hard handovers if in a connection or any physical/transport/radio bearer reconfiguration that implies a change of UARFCN and/or PSC. The state will accordingly change due to a handover or to the locking cell loss.
AT+UCELLLOCK=0	OK	The cell lock is disabled.

### 17.1.6 Cell lock in 3G network: extended mode

LISA-U2

SARA-U2

TOBY-L2

Command	Response	Description
AT+CMEE=2	OK	Set the verbose error result codes.
AT+COPS=2	OK	Deregister the module prior the lock.
AT+URAT=2	OK	Set the UMTS RAT.
AT+UCELLLOCK=5,, ,10838,6	OK	An extended cell lock is set on UARFCN 10838, PSC 6 enabling the URC.
AT+COPS=0	OK	Set the automatic network selection.
	+UCELLLOCK: 1,2	If the URC mode is enabled then the cell lock state will be reported. In extended mode the module does not perform any soft/hard handovers if in a connection but it will still obey to physical/transport/radio bearer reconfiguration that implies a change of UARFCN and/or PSC. The state will accordingly change due to a handover or to the locking cell loss.
AT+UCELLLOCK=0	OK	The cell lock is disabled.

### 17.1.7 Cell lock in 3G network: extended + redirection mode

LISA-U2

SARA-U2

TOBY-L2

Command	Response	Description
AT+CMEE=2	OK	Set the verbose error result codes.
AT+COPS=2	OK	Deregister the module prior the lock.
AT+UCELLLOCK=7,, ,10838,6	OK	An extended + redirection cell lock is set on UARFCN 10838, PSC 6 enabling the URC.
AT+URAT=2	OK	Set the UMTS RAT.
AT+COPS=0	OK	Set the automatic network selection.
	+UCELLLOCK: 1,2	If the URC mode is enabled then the cell lock state will be reported. In extended mode the module does not perform any soft/hard handovers if in a connection and does not obey to physical/transport/radio bearer reconfiguration that implies a change of UARFCN and/or PSC. The state will accordingly change due to a handover or to the locking cell loss.
AT+UCELLLOCK=0	OK	The cell lock is disabled.

### 17.1.8 Cell lock in 4G network: normal mode

TOBY-L2

Command	Response	Description
AT+CMEE=2	OK	Set the verbose error result codes.
AT+COPS=2	OK	Deregister the module prior the lock.
AT+URAT=3	OK	Set the LTE RAT.
AT+UCELLLOCK=3,,,, ,900,0	OK	A normal cell lock is set on EARFCN 900, P-CID 0 enabling the URC.
AT+COPS=0	OK	Set the automatic network selection.
	+UCELLLOCK: 1,3	The URC reports the cell lock state. In normal mode the module performs soft/hard handovers if in a connection or any physical / transport / radio bearer reconfiguration that implies a change of UARFCN and/or PSC. The state will

Command	Response	Description
		accordingly change due to a handover or to the locking cell loss.
AT+UCELLLOCK=0	OK	The cell lock is disabled.

### 17.1.9 Cell lock in 4G network: extended mode

#### TOBY-L2

Command	Response	Description
AT+CMEE=2	OK	Set the verbose error result codes.
AT+COPS=2	OK	Deregister the module prior the lock.
AT+URAT=3	OK	Set the LTE RAT.
AT+UCELLLOCK=5,,,,,6300,337	OK	An extended cell lock is set on EARFCN 6300, P-CID 337 enabling the URC.
AT+COPS=0	OK	Set the automatic network selection.
	+UCELLLOCK: 1,3	The URC reports the cell lock state. In extended mode the module does not perform any soft/hard handovers if in a connection but it will still obey to physical/transport/radio bearer reconfiguration that implies a change of UARFCN and/or PSC. The state will accordingly change due to a handover or to the locking cell loss.
AT+UCELLLOCK=0	OK	The cell lock is disabled.

### 17.1.10 Cell lock in 4G network: extended + redirection mode

#### TOBY-L2

Command	Response	Description
AT+CMEE=2	OK	Set the verbose error result codes.
AT+COPS=2	OK	Deregister the module prior the lock.
AT+UCELLLOCK=7,,,,,6300,337	OK	An extended + redirection cell lock is set on EARFCN 6300, P-CID 337 enabling the URC.
AT+URAT=3	OK	Set the LTE RAT.
AT+COPS=0	OK	Set the automatic network selection.
	+UCELLLOCK: 1,3	The URC reports the cell lock state. In extended mode the module does not perform any soft/hard handovers if in a connection and does not obey to physical/transport/radio bearer reconfiguration that implies a change of EARFCN and/or P-CID. The state will accordingly change due to a handover or to the locking cell loss.
AT+UCELLLOCK=0	OK	The cell lock is disabled.



## 17.2 Cell lock in multi-mode

### 17.2.1 Cell lock in dual-mode: normal mode

<div style="display: inline-block; border: 1px solid black; border-radius: 5px; padding: 2px 5px; margin-right: 10px;">LISA-U2</div> <div style="display: inline-block; border: 1px solid black; border-radius: 5px; padding: 2px 5px; margin-right: 10px;">SARA-U2</div> <div style="display: inline-block; border: 1px solid black; border-radius: 5px; padding: 2px 5px;">TOBY-L2</div>			
Command	Response	Description	
AT+CMEE=2	OK	Set the verbose error result codes.	
AT+COPS=2	OK	Deregister the module prior the lock.	
AT+URAT=1, 2		Set the dual RAT.	
AT+UCELLLOCK=3, 100, 0, 10838, 6	OK	A normal cell lock is set on both ARFCN 100 and UARFCN 10838 and PSC 6, enabling the URC.	
AT+COPS=0	OK	Set the automatic network selection.	
	+UCELLLOCK: 1, 2	If the URC mode is enabled then the cell lock state will be reported. In normal mode the module performs handovers if in a connection. Changes of RAT are allowed only to the other locking cell. The state will accordingly change due to a handover, a RAT change or to the locking cell loss.	
AT+UCELLLOCK=0	OK	The cell lock is disabled.	

### 17.2.2 Cell lock in dual-mode: extended mode

<div style="display: inline-block; border: 1px solid black; border-radius: 5px; padding: 2px 5px; margin-right: 10px;">LISA-U2</div> <div style="display: inline-block; border: 1px solid black; border-radius: 5px; padding: 2px 5px; margin-right: 10px;">SARA-U2</div> <div style="display: inline-block; border: 1px solid black; border-radius: 5px; padding: 2px 5px;">TOBY-L2</div>			
Command	Response	Description	
AT+CMEE=2	OK	Set the verbose error result codes.	
AT+COPS=2	OK	Deregister the module prior the lock.	
AT+URAT=1, 2		Set the dual RAT.	
AT+UCELLLOCK=5, 100, 0, 10838, 6	OK	An extended + redirection cell lock is set on both ARFCN 100 and UARFCN 10838 and PSC 6, enabling the URC.	
AT+COPS=0	OK	Set the automatic network selection.	
	+UCELLLOCK: 1, 1	If the URC mode is enabled then the cell lock state will be reported. In extended mode the module does not perform any soft/hard handovers if in a connection but it will still obey to physical/transport/radio bearer reconfiguration that implies a change of UARFCN and/or PSC. Changes of RAT are allowed only to the other locking cell. The state will accordingly change due to a handover, a RAT change or to the locking cell loss.	
AT+UCELLLOCK=0	OK	The cell lock is disabled.	

### 17.2.3 Cell lock in dual-mode: extended + redirection mode

<div style="display: inline-block; border: 1px solid black; border-radius: 5px; padding: 2px 5px; margin-right: 10px;">LISA-U2</div> <div style="display: inline-block; border: 1px solid black; border-radius: 5px; padding: 2px 5px; margin-right: 10px;">SARA-U2</div> <div style="display: inline-block; border: 1px solid black; border-radius: 5px; padding: 2px 5px;">TOBY-L2</div>			
Command	Response	Description	
AT+CMEE=2	OK	Set the verbose error result codes.	
AT+COPS=2	OK	Deregister the module prior the lock.	
AT+URAT=1, 2		Set the dual RAT.	
AT+UCELLLOCK=7, 100, 0, 10838, 6	OK	An extended cell lock is set on both ARFCN 100 and UARFCN 10838 and PSC 6, enabling the URC.	

Command	Response	Description
AT+COPS=0	OK	Set the automatic network selection.
	+UCELLLOCK: 1,1	If the URC mode is enabled then the cell lock state will be reported. In extended mode the module does not perform any soft/hard handovers if in a connection and does not obey to physical/transport/radio bearer reconfiguration that implies a change of UARFCN and/or PSC. In 2G this is equivalent to the extended mode. Changes of RAT are allowed only to the other locking cell. The state will accordingly change due to a handover, a RAT change or to the locking cell loss.
AT+UCELLLOCK=0	OK	The cell lock is disabled.

## 17.2.4 Cell lock in tri-mode: normal mode

### TOBY-L2

Command	Response	Description
AT+CMEE=2	OK	Set the verbose error result codes.
AT+COPS=2	OK	Deregister the module prior the lock.
AT+URAT=4,3		Set the tri RAT.
AT+UCELLLOCK=3,100,0,10838,6,6 300,337	OK	A normal cell lock is set on 2G cell ARFCN 100, 3G cell UARFCN 10838, PSC 6 and 4G cell EARFCN 6300, P-CID 337, enabling the URC.
AT+COPS=0	OK	Set the automatic network selection.
	+UCELLLOCK: 1,3	The module searches for any of the three locking cells and camps on the first cell found. The URC reports the cell lock state. In normal mode the module performs handovers if in a connection. Changes of RAT are allowed only to the other locking cell. The state will accordingly change due to a handover, a RAT change or to the locking cell loss.
AT+UCELLLOCK=0	OK	The cell lock is disabled.

## 17.2.5 Cell lock in tri-mode: extended mode

### TOBY-L2

Command	Response	Description
AT+CMEE=2	OK	Set the verbose error result codes.
AT+COPS=2	OK	Deregister the module prior the lock.
AT+URAT=4,3		Set the tri RAT.
AT+UCELLLOCK=5,100,0,10838,6,6 300,337	OK	An extended + redirection cell lock is set on 2G cell ARFCN 100, 3G cell UARFCN 10838, PSC 6 and 4G cell EARFCN 6300, P-CID 337, enabling the URC.
AT+COPS=0	OK	Set the automatic network selection.
	+UCELLLOCK: 1,3	The module searches for any of the three locking cells and camps on the first cell found. The URC reports the cell lock state. In extended mode the module does not perform any soft/hard handovers if in a connection but it will still obey to physical/transport/radio bearer reconfiguration that implies a change of UARFCN and/or PSC. Changes of RAT are allowed only to the other locking cell. The state

Command	Response	Description
		will accordingly change due to a handover, a RAT change or to the locking cell loss.
AT+UCELLLOCK=0	OK	The cell lock is disabled.

## 17.2.6 Cell lock in tri-mode: extended + redirection mode

### TOBY-L2

Command	Response	Description
AT+CMEE=2	OK	Set the verbose error result codes.
AT+COPS=2	OK	Deregister the module prior the lock.
AT+URAT=4, 3		Set the tri RAT.
AT+UCELLLOCK=7, 100, 0, 10838, 6, 6300, 337	OK	An extended cell lock is set on on 2G cell ARFCN 100, 3G cell UARFCN 10838, PSC 6 and 4G cell EARFCN 6300, P-CID 337, enabling the URC.
AT+COPS=0	OK	Set the automatic network selection.
	+UCELLLOCK: 1, 3	The module searches for any of the three locking cells and camps on the first cell found. The URC reports the cell lock state. In extended mode the module does not perform any soft/hard handovers if in a connection and does not obey to physical/transport/radio bearer reconfiguration that implies a change of UARFCN and/or PSC. In 2G this is equivalent to the extended mode. Changes of RAT are allowed only to the other locking cell. The state will accordingly change due to a handover, a RAT change or to the locking cell loss.
AT+UCELLLOCK=0	OK	The cell lock is disabled.

## 18 ADC AT commands

LEON-G1

 Not supported by LEON-G200 modules.

Command	Response	Description
AT+CMEE=2	OK	Set the verbose error result codes.
AT+UADC=?	+UADC: (0) OK	List of the supported ADCs.
AT+UADC=0	+UADC: 0, 473 OK	Check the current value (in millivolts) of the specified ADC.

# 19 GPIO AT commands

LEON-G1
LISA-U2
SARA-G3
SARA-G4
SARA-U2
TOBY-L2

Not supported by SARA-G300 / SARA-G310 modules.

For more details about GPIO pin mapping, see the corresponding module system integration manual [\[3\]](#), [\[6\]](#), [\[7\]](#), [\[11\]](#), [\[17\]](#), [\[18\]](#), [\[19\]](#).

Command	Response	Description
AT+CMEE=2	OK	Set the verbose error result codes.
AT+UGPIOR=?	+UGPIOR: (20, 21) OK	List of GPIO pin numbers.
AT+UGPIOC=20,0,0	OK	Set up the GPIO input / output mode: <ul style="list-style-type: none"> <li>GPIO1 in output mode with default value 0</li> <li>GPIO2 in input mode (no default value can be set)</li> </ul>
AT+UGPIOC=21,1	OK	
AT+UGPIOR=20	+UGPIOR: 20,0 OK	Read the GPIO status.
AT+UGPIOR=21	+UGPIOR: 21,1 OK	
AT+UGPIOW=20,1	OK	Write (set) the GPIO status. Only GPIO configured in output mode can be written.
AT+UGPIOC=21,2	OK	Configure GPIO2 to be used as network indication.
AT+UGPIOC=?	+UGPIOC: (20,21), (0-3), (0-1) 20, 0, 1 21, 2 OK	Provides GPIO status (GPIO1 is an output with value 1 and GPIO2 is set as network indication). On LISA-U1 / LISA-U2 / SARA-U2 series the configuration of each GPIO pin is provided through the read command.
AT+UGPIOW=21,1	+CME ERROR: Write GPIO error	Write into a GPIO in non-output mode. An error is returned.

TOBY-R2
LARA-R2

Command	Response	Description
AT+CMEE=2	OK	Set the verbose error result codes.
AT+UGPIOR=?	+UGPIOR: (21,22,24,25,50,51,52,53,60) OK	List of GPIO pin numbers.
AT+UGPIOC=21,0,0	OK	Set up the GPIO input / output mode: <ul style="list-style-type: none"> <li>GPIO1 in output mode with default value 0</li> <li>GPIO2 in input mode (no default value can be set)</li> </ul>
AT+UGPIOC=22,1	OK	
AT+UGPIOR=21	+UGPIOR: 21,0 OK	Read the GPIO status.
AT+UGPIOR=22	+UGPIOR: 22,1 OK	
AT+UGPIOW=21,1	OK	Write (set) the GPIO status. Only GPIO configured in output mode can be written.
AT+UGPIOC=22,2	OK	Configure GPIO2 to use as network indication.
AT+UGPIOC=?	+UGPIOC: (21,22,24,25,50,51,52,53,60), (0,1,2,7,12,255), (0-1) 21, 0, 1 22, 1 [...] OK	Provides GPIO status (GPIO1 is an output with value 1 and GPIO2 is set as an input).

Command	Response	Description
AT+UGPIOW=22,1	+CME ERROR: Write GPIO error	Write into a GPIO in non-output mode. An error is returned.

## 20 Multiplexer AT commands

LEON-G1

LISA-U2

SARA-G3



SARA-G4

SARA-U2

TOBY-L2

TOBY-R2

LARA-R2

-  Not supported by TOBY-L2 "00S" product version.
-  For the multiplexer configuration applicable to u-blox cellular modules, see the u-blox AT Commands Manual [\[1\]](#).
-  The +CMUX AT command must be sent by the mux driver on the host. When the control channel is closed, the mux is disabled. To close the mux channel it is necessary to stop the mux driver; after this the channel #0 will not be seen as a virtual port.

Command	Response	Description
AT+CMEE=2	OK	Set verbose error result codes.
AT+CMUX=0,0,0,1400,253,3,254,0,0	OK	Enable the multiplexer on the module. Once it is started the connection is handled using the multiplexing protocol as defined in 3GPP TS 27.010 <a href="#">[2]</a> .

## 21 File system AT commands

LEON-G1

LISA-U2

SARA-G3



SARA-G4

SARA-U2

TOBY-L2

TOBY-R2

LARA-R2

-  Not supported by SARA-G300 / SARA-G310 modules.
-  The commands in this section refer to the module's local file system. The size of the file system is limited by the available memory. For more details, u-blox AT Commands Manual [\[1\]](#).

Command	Response	Description
AT+CMEE=2	OK	Set the verbose error result codes.
AT+ULSTFILE=	+ULSTFILE: "a_file", "another_file", "mydata" OK	List all the files in the file system.
AT+ULSTFILE=1	+ULSTFILE: 1012131 OK	Get free space in the file system (in bytes).
AT+ULSTFILE=2, "a_file"	+ULSTFILE: 24365 OK	Get the file size of "a_file" file (in bytes).
AT+ULSTFILE=2, "some_name"	+ULSTFILE: 0 OK	If the specified file does not exist a 0 bytes dimension is returned.
AT+UDWNFILE="new_file", 12	>	Request the creation of a new file on file system specifying file name and file size (in bytes). Wait for the ">" symbol indicating the data prompt is now open (AT commands are not allowed in data prompt).
Hello World!	OK	Send to the serial port the bytes to be written in the specified file.
		 It is not possible to write fewer bytes than previously specified with AT+UDWNFILE command.  If more bytes are written respect to the threshold, the remaining bytes will be truncated. The interface is blocked until all the bytes are written. When the requested number of bytes is written, the module exits from data prompt, the "OK" final result code is returned if no error occurred during file creation.
AT+ULSTFILE=	+ULSTFILE: "a_file", "another_file", "mydata", "new_file" OK	List again all the files in the file system.
AT+ULSTFILE=2, "new_file"	+ULSTFILE: 12 OK	Get file size of "new_file" file (in bytes). The size is exactly the size requested when the file was created with +UDWNFILE.
AT+URDFILE="new_file"	+URDFILE: new_file, 12, "Hello World!" OK	Read the just created file ("new_file").
AT+UDELFILE="new_file"	OK	Delete the file called "new_file".
AT+ULSTFILE=	+ULSTFILE: "a_file", "another_file", "mydata" OK	List all the files in the file system.



## 22 SIM toolkit

LEON-G1

LISA-U2

SARA-G3

SARA-U2

TOBY-R2

LARA-R2



SIM Application Toolkit (SAT) is a set of commands and procedures which may be used during a GSM session. The SAT provides mechanisms which allow applications, existing in the SIM, to interact and operate with any MT, which supports the specific mechanisms required by the application.

The specifications related to SIM toolkit are u-blox AT Commands Manual [1], 3GPP TS 27.010 [2], 3GPP TS 51.011 [4] and 3GPP TS 51.014 [5].

Similarly, USAT (USIM Application Toolkit) provides mechanisms which allow applications, existing in the UICC, to interact and operate with any ME which supports the specific mechanism(s) required by the application (3GPP TS 31.111 [8]).

The usage of the SAT / USAT feature can be activated by sending AT+CFUN=6; this enables the SIM-toolkit interface and fetching of proactive commands by SIM-APPL from the SIM-card. After the activation of the SIM toolkit interface, the +STKPRO URC displays the setup menu when available from the SIM (immediately or after PIN insertion) and notifies any following SIM toolkit commands. In particular, if user interaction is required, the response to the +STKPRO URC shall be usually entered within a 20 to 60s timer, otherwise a negative terminal response might be autonomously returned by the device.

The commands in this section work properly only if the DTE has activated the SIM toolkit interface. If the SIM-toolkit interface is not enabled, the USAT processing will negatively answered to the SIM card if user interaction is required (e.g. in case of "DISPLAY TEXT" command) or autonomously handled by the device (e.g. SIM refresh commands).

-  In the following sections, SIM is equivalent to USIM and SAT is equivalent to USAT.
-  TOBY-L2 series has an equivalent SIM toolkit functionality but the AT command syntax is different. The mapping can be derived from u-blox AT Commands Manual [1].
-  AT+CFUN=9 (where supported) enables the SIM toolkit interface in binary mode. The syntax of USAT commands and URCs in binary mode for each product series can be found in u-blox AT Commands Manual [1].

### 22.1 Profile download

The profile downloading provides a mechanism for the MT to tell the SIM what it is capable of, and the SIM can then limit its instruction range accordingly. If the MT does not send the terminal profile, the SIM shall assume that the MT does not support SIM Application Toolkit.

The +STKPROF AT command can query the Terminal Profile and the information text response is the list of SAT facilities supported by the MT, as specified in 3GPP TS 51.014 [5] or in 3GPP TS 31.111 [8].

Command	Response	Description
AT+CFUN=6	OK	SAT activation (if not already enabled).
AT+STKPROF?	+STKPROF: 17, "FFFFFFF7F0300D F7F00000000010A0003" OK	The reading result of the terminal profile data.

-  The terminal profile is sent at power up from MT to SIM, no matter if SAT is enabled or not.

## 22.2 Proactive SIM

A proactive SIM is a SIM that is capable of issuing commands to the MT. The MT is always the "master" and initiates commands to the SIM, and therefore there is no mechanism for the SIM to initiate a communication with the MT. This limits the possibility of introducing new SIM features requiring the support of the MT, as the MT needs to know in advance what actions it should take. The SIM shall execute all SAT proactive commands or procedures in such a way as not to jeopardize, or cause suspension, of service provisioning to the user.

Proactive SIM gives a mechanism whereby the SIM can initiate actions to be taken by the MT. These actions include:

- Displaying text from the SIM to the MT
- Sending a short message
- Setting up a voice call to a number held by the SIM
- Setting up a data call to a number and bearer capabilities held by the SIM
- Sending an SS control or USSD string
- Playing tone in earpiece
- Initiating a dialogue with the user
- SIM initialization request and notification of changes to EF(s)
- Providing local information from the MT to the SIM
- Communicating with the additional card(s) (if class "a" is supported)
- Providing information about the additional card reader(s) (if class "a" is supported)
- Managing timers running physically in the MT
- Running an AT command received from the SIM, and returning the result to the SIM (if class "b" is supported)
- Sending DTMF
- Requesting the MT to launch the browser corresponding to a URL (if class "c" is supported)
- Establishing and managing a bearer independent protocol (if class "e" is supported)

The information text response to the test command of +STKPRO lists the supported proactive commands.

Command	Response	Description
AT+CFUN=6	OK	SAT activation (if not already enabled).
AT+STKPRO=?	+STKPRO: (01,05,16,17,18,19,20,21,32,33,34,35,36,37,38,40,53) OK	List of the supported proactive commands.

Referring to 3GPP TS 51.014 [5] (or ETSI 102.223 [9]), this means that the module supports the following proactive commands:

- 01 (0x01) – REFRESH
- 05 (0x05) – SETUP EVENT LIST
- 16 (0x10) – SETUP CALL
- 17 (0x11) – SEND SS
- 18(0x12) – SEND USSD
- 19(0x13) – SEND SMS
- 20(0x14) – SEND DTMF
- 21(0x15) – LAUNCH BROWSER
- 32 (0x20) – PLAY TONE
- 33 (0x21) – DISPLAY TEXT
- 34 (0x22) – GET INKEY
- 35 (0x23) – GET INPUT

- 36 (0x24) – SELECT ITEM
- 37 (0x25) – SETUP MENU
- 38 (0x26) – PROVIDE LOCAL INFO
- 40 (0x28) – SETUP IDLE MODE TEXT
- 53 (0x35) – LANGUAGE NOTIFICATION

## 22.3 Example

### 22.3.1 Enable the SAT and terminal response

Command	Response	Description
AT+CFUN=6	OK	SAT activation (if not already enabled).
	+STKPRO: 37,"STK-JavaCard",1,1,"AA",0	The URC displays the SAT main menu.
AT+STKTR=37,0	OK	Response to the previous SIM Toolkit proactive command which has been displayed by the +STKPRO URC.
	+STKCNF: 37,0,255,144	URC displaying the SAT proactive session status: <ul style="list-style-type: none"> <li>• 37: set up menu</li> <li>• 0: command performed successfully</li> <li>• 255: no additional info</li> <li>• 144: normal ending of the command</li> </ul>

### 22.3.2 Changing the terminal profile

Command	Response	Description
AT+CFUN=6	OK	SAT activation (if not already enabled).
	+STKPRO: 37,"STK-JavaCard",1,1,"AA",0	The URC provides the SAT main menu.
AT+STKTR=37,0	OK	Response to the previous SIM Toolkit proactive command which has been displayed by the +STKPRO URC.
	+STKCNF: 37,0,255,144	URC displaying the SAT proactive session status: <ul style="list-style-type: none"> <li>• 37: set up menu</li> <li>• 0: command performed successfully</li> <li>• 255: no additional info</li> <li>• 144: normal ending of the command</li> </ul>
AT+STKPROF?	+STKPROF: 17,"FFFFFFFF7F0300D F7F00000000010A0003" OK	The reading result of the terminal profile data.
AT+STKPROF=2,"FF03"	OK	Modify the terminal profile value.
AT+CPWROFF	OK	Switch off the module to save the current configuration.
(powering on module again)		
AT+STKPROF?	+CME ERROR: operation not allowed	The SAT must be activated at next power up.
AT+CFUN=6	OK	SAT activation (if not already enabled).
AT+STKPROF?	+STKPROF: 2,"FF03" OK	The reading result of the terminal profile data.
AT+STKPROF=0	OK	Forces a reset to the default terminal profile stored in the MT.
AT+STKPROF?	+STKPROF: 17,"FFFFFFFF7F0300D F7F00000000010A0003" OK	The reading result of the terminal profile data.
AT+CPWROFF	OK	Switch off the module to save the current configuration.

### 22.3.3 Entering SAT menu and selecting an item

Command	Response	Description
AT+CFUN=6	OK	SAT activation (if not already enabled).
	+STKPRO: 37,"STK- JavaCard",1,1,"AA",0	The URC displays the SAT main menu.
AT+STKTR=37,0	OK	Response to the previous SIM Toolkit proactive command which has been displayed by the URC +STKPRO.
	+STKCNF: 37,0,255,144	URC displaying the SAT proactive session status: <ul style="list-style-type: none"> <li>• 37: set up menu</li> <li>• 0: command performed successfully</li> <li>• 255: no additional info</li> <li>• 144: normal ending of the command</li> </ul>
AT+STKENV=211,1	+STKCNF: 129,0,255,145 OK	Send command "Menu Selection" to the SIM. The +STKCNF command displays the proactive session status: <ul style="list-style-type: none"> <li>• 129: end of proactive session</li> <li>• 0: command performed successfully</li> <li>• 255: no additional info</li> <li>• 145: normal ending of the command</li> </ul>
	+STKPRO: 36,"Commands",1,6,"S IM - ME",0,0	SAT submenu consisting in 6 items of type "Select item".
	+STKPRO: 36,"Commands",2,6,"S IM - Display",0,0	
	+STKPRO: 36,"Commands",3,6,"S IM - Earpiece",0,0	
	+STKPRO: 36,"Commands",4,6,"S IM - Network",0,0	
	+STKPRO: 36,"Commands",5,6,"S IM - Card reader",0,0	
	+STKPRO: 36,"Commands",6,6,"S pecial",0,0	
AT+STKTR=36,0,0,0,0,"02"	OK	Terminal response: select item "2".
	+STKCNF: 36,0,255,144	Proactive session status.
	+STKPRO: 36,"Display Text",1,3,"ASCII 7 bit",0,0	SAT submenu consisting in 3 items of type "Select item".
	+STKPRO: 36,"Display Text",2,3,"UCS2",0,0	
	+STKPRO: 36,"Display Text",3,3,"Icon",0,0	

### 22.3.4 Call setup

Command	Response	Description
AT+CFUN=6	OK	Activate the SAT (if not already enabled).
	+STKPRO: 37,"STK-JavaCard",1, 1,"AA",0	SAT URC which displays to user the SAT main menu.
AT+STKTR=37,0	OK	Response to the previous SIM Toolkit proactive command which has been displayed by the URC +STKPRO.
	+STKCNF: 37,0,255,144	URC displaying the SAT proactive session status: <ul style="list-style-type: none"> <li>• 37: set up menu</li> <li>• 0: command performed successfully</li> </ul>

Command	Response	Description
AT+STKENV=211,1	+STKCNF: 129,0,255,145 OK	<ul style="list-style-type: none"> <li>255: no additional info</li> <li>144: normal ending of the command</li> </ul> Send command "Menu Selection" to the SIM. The +STKCNF URC displays the proactive session status: <ul style="list-style-type: none"> <li>129: end of proactive session</li> <li>0: command performed successfully</li> <li>255: no additional info</li> <li>145: normal ending of the command</li> </ul>
	+STKPRO: 36,"Commands",1,6,"SIM - ME",0,0	SAT submenu consisting in 6 items of type "Select item".
	+STKPRO: 36,"Commands",2,6,"SIM - Display",0,0	
	+STKPRO: 36,"Commands",3,6,"SIM - Earpiece",0,0	
	+STKPRO: 36,"Commands",4,6,"SIM - Network",0,0	
	+STKPRO: 36,"Commands",5,6,"SIM - Card reader",0,0	
	+STKPRO: 36,"Commands",6,6,"SIM - Special",0,0	
AT+STKTR=36,0,0,0,0,"04"	OK	Terminal response: select item "4".
	+STKCNF: 36,0,255,144	Proactive session status.
	+STKPRO: 36,"SIM - Network",1,5,"DTMF",0,0	SAT submenu consisting in 5 items of type "Select item".
	+STKPRO: 36,"SIM - Network",2,5,"SMS",0,0	
	+STKPRO: 36,"SIM - Network",3,5,"Send SS",0,0	
	+STKPRO: 36,"SIM - Network",4,5,"USSD",0,0	
	+STKPRO: 36,"SIM - Network",5,5,"Setup Call",0,0	
AT+STKTR=36,0,0,0,0,"05"	OK	Terminal response: select item "4".
	+STKCNF: 36,0,255,144	Proactive session status.
	+STKPRO: 35,0,4,"456E746572206469616C206E6F2E",20,2,,0	SAT requires GET INPUT (35); <hex_string> is "Enter dial no."
AT+STKTR=35,0,0,0,4,"3132333435"	OK	Terminal response GET INPUT (calling number is "12345").
	+STKCNF: 35,0,255,145	Proactive session status.
	+STKCC: 1,0,,"12345"	URC displaying control status.
	+STKPRO: 16,"12345",,"",0,"calling...",0,0	Proactive session transaction.
AT+STKTR=16,0	OK	Terminal response to SETUP CALL.
	NO CARRIER	(in this test no GSM network available)
	+STKCNF: 16,32,4,145	Proactive session status: <ul style="list-style-type: none"> <li>16: setup call</li> <li>32: MT currently unable to process command</li> <li>4: no service (see 3GPP TS 51.014 [5], additional result)</li> <li>145: normal ending of the command</li> </ul>

Command	Response	Description
	+STKPRO: 33,129,4,"526573756C743A203230",0,0	Proactive session transaction: DISPLAY TEXT. Text is "Result: 20".
	+STKCNF: 33,18,255,144	Proactive session status: <ul style="list-style-type: none"> <li>• 33: display text</li> <li>• 18: no response from user</li> <li>• 255: no additional info</li> <li>• 144: normal ending of the command</li> </ul>

### 22.3.5 SIM Refresh proactive command handling

Precondition: the SIM-toolkit interface has been enabled in dedicated mode by sending the AT+CFUN=6 command.

If SIM-toolkit interface is not enabled, the SIM Refresh commands will be autonomously handled by the device and the user application can monitor SIM status or registration URC to understand that the SIM application has been refreshed.

#### 22.3.5.1 Refresh: USIM initialization and full file change notification

Command	Response	Description
	+STKPRO: 01,0,0,""	The URC displays the Refresh – USIM Initialization and Full File Change Notification proactive command.
AT+STKTR=01,0	OK	Response to the previous SIM Toolkit proactive command which has been displayed by the +STKPRO URC.
	+STKCNF: 1,0,255,144	URC displaying the SAT proactive session status: <ul style="list-style-type: none"> <li>• 1: refresh</li> <li>• 0: command performed successfully</li> <li>• 255: no additional info</li> <li>• 144: normal ending of the command</li> </ul>

#### 22.3.5.2 Refresh: file change notification

Command	Response	Description
	+STKPRO: 01,1,1,"3F007F106F3B"	The URC displays the Refresh - File Change Notification proactive command.
AT+STKTR=01,0	OK	Response to the previous SIM Toolkit proactive command which has been displayed by the +STKPRO URC.
	+STKCNF: 1,0,255,144	URC displaying the SAT proactive session status: <ul style="list-style-type: none"> <li>• 1: refresh</li> <li>• 0: command performed successfully</li> <li>• 255: no additional info</li> <li>• 144: normal ending of the command</li> </ul>

### 22.3.5.3 USIM initialization and file change notification

Command	Response	Description
	+STKPRO: 01,2,1,"3F007F206F38"	The URC displays the Refresh - USIM Initialization and File Change Notification proactive command.
AT+STKTR=01,0	OK	Response to the previous SIM Toolkit proactive command which has been displayed by the +STKPRO URC.
	+STKCNF: 1,0,255,144	URC displaying the SAT proactive session status: <ul style="list-style-type: none"> <li>• 1: refresh</li> <li>• 0: command performed successfully</li> <li>• 255: no additional info</li> <li>• 144: normal ending of the command</li> </ul>

### 22.3.5.4 USIM initialization

Command	Response	Description
	+STKPRO: 01,3,0,""	The URC displays the Refresh - USIM Initialization proactive command.
AT+STKTR=01,0	OK	Response to the previous SIM Toolkit proactive command which has been displayed by the +STKPRO URC.
	+STKCNF: 1,0,255,144	URC displaying the SAT proactive session status: <ul style="list-style-type: none"> <li>• 1: refresh</li> <li>• 0: command performed successfully</li> <li>• 255: no additional info</li> <li>• 144: normal ending of the command</li> </ul>

### 22.3.6 UICC reset

Command	Response	Description
	+STKPRO: 01,4,0,""	The URC displays the Refresh - UICC Reset proactive command.
AT+STKTR=1,0	OK	Response to the previous SIM Toolkit proactive command which has been displayed by the +STKPRO URC.
	+STKCNF: 1,0,255,144	URC displaying the SAT proactive session status: <ul style="list-style-type: none"> <li>• 1: refresh</li> <li>• 0: command performed successfully</li> <li>• 255: no additional info</li> <li>• 144: normal ending of the command</li> </ul>

### 22.3.7 Envelope: idle screen available

In case the SIM card needs to display text, it might ask the UE to notify the “Idle screen available” status. In this case a Setup Event List USAT command will list the specific event, that the user shall notify the SIM card by sending an appropriate envelope command.

Command	Response	Description
	+STKPRO: 05,5	The URC displays the Set Up Event List – Idle Screen available event proactive command
AT+STKTR=05,0	OK	Response to the previous SIM Toolkit proactive command which has been displayed by the +STKPRO URC.
	+STKCNF: 5,0,255,144	URC displaying the SAT proactive session status: <ul style="list-style-type: none"> <li>• 5: Set Up Event List</li> </ul>

Command	Response	Description
		<ul style="list-style-type: none"> <li>0: command performed successfully</li> <li>255: no additional info</li> <li>144: normal ending of the command</li> </ul>
AT+STKENV=214,5	OK	Send envelope: <ul style="list-style-type: none"> <li>214: Event download</li> <li>5: idle screen available</li> </ul>

## 22.3.8 IMSI swap

IMSI swap is the procedure triggered by the SIM card to change Subscriber Identity, e.g. as a reaction of the SIM itself to the notifications of a roaming condition or after a change of subscription. In this case, the user might need to be notified of the specific USAT SIM refresh procedure in order to update the IMSI value via +CIMI.

### 22.3.8.1 SAT interface disabled

**TOBY-L2**

Assuming the IMSI swap is triggered in registered state, the application has just to monitor the registration URCs (which depend on the initial RAT), as all proactive commands are managed automatically by the module.

Command	Response	Description
AT+CIMI	222107701772423 OK	Current IMSI.
AT+COPS?	+COPS: 0,0,"MD8475ASmartStudio",7 OK	Module registered on LTE.
		An IMSI swap is now triggered. At the end a REFRESH proactive command is sent to the SIM.
	+CREG: 0	The REFRESH command causes a mobile originated detach and a re-attach of the module from/to the network. Initial default EPS bearer is deactivated and re-activated.
	+CREG: 2	
	+CGEV: NW PDN DEACT 4	
	+CGEV: ME PDN ACT 4	The attach with the new identity (IMSI) is performed.
	+CREG: 2,1,"0000","00000000",7	
AT+CIMI	222887756772378 OK	Current IMSI.

### 22.3.8.2 SAT interface in dedicated mode (+CFUN: 6)

**TOBY-L2**

The application in this case has to monitor the URCs and also to provide the response to the proactive commands.

Command	Response	Description
AT+CIMI	222107701772423 OK	Read the current IMSI.
AT+CFUN=6	OK	SAT interface in dedicated mode.
AT+COPS?	+COPS: 0,0,"MD8475ASmartStudio",6 OK	Module registered on UMTS.



Command	Response	Description
	+CREG: 0	An IMSI swap is now triggered. At the end a REFRESH proactive command is sent to the SIM.
	+UCATPROI: 01,0	The REFRESH command causes a detach from the network.
	+CREG: 2	The +UCATPROI URC displays the proactive commands coming from the SIM that require a response from the user via +UCATTR command
	+CGEV: ME DETACH	
AT+UCATTR=01,0	OK	The application sends the response to the SIM toolkit proactive command (REFRESH).  TOBY-L2 "03" and previous product versions do not wait for user answer and perform automatically the REFRESH without need for +UCATTR command.
	+CREG: 2,1,"0000","00000000",6	After the REFRESH is completed, the attach with the new identity (IMSI) is performed.
AT+CIMI	222887756772378	Read the current IMSI.
	OK	

## 23 SMS AT commands

LEON-G1

LISA-U2

SARA-G3

SARA-G4

SARA-U2

TOBY-L2

TOBY-R2

LARA-R2

### 23.1 Read all messages or one single message

Command	Response	Description
AT+CMGF=1	OK	Set the preferred message format to text mode.
AT+CPMS?	+CPMS: "ME", 3, 300, "ME", 3, 300, "ME", 3, 300 OK	Check which memories are active for reading, deleting, storing, sending and receiving messages.
AT+CPMS="MT"	+CPMS: 5, 350, 3, 300, 3, 300 OK	Set the preferred message storage to "MT" (that means SIM card + module file system) for read and delete cases. On SARA-G300 / SARA-G310 the supported options are "SM" and "BM". On TOBY-R2 / LARA-R2 the supported option is "ME".
AT+CMGL	+CMGL: 1, "REC READ", "12345", , , "10/09/09,15:06:30+08" Test message 1 +CMGL: 2, "STO SENT", "67890", , , abcdefghijklmnopqrstuvwxy +CMGL: 3, "STO UNSENT", " , , , , Test message 2 +CMGL: 301, "REC READ", "54321", , , "08/08/09,10:01:38+08" Hello world +CMGL: 302, "REC UNREAD", "9876", , , "09/08/09,10:05:40+08" Test message 3 OK	Display the message list (both on module file system and SIM card).
AT+CMGR=301	+CMGR: "REC READ", "54321", , , "08/08/09,10:01:38+08" Hello world OK	Read a single message from SIM card since the index is greater than 300 (number of SMS stored in the module file system).
AT+CMGR=2	+CMGR: "STO SENT", "67890" abcdefghijklmnopqrstuvwxy OK	Read a single message from the module file system since the index is lower than 300 (number of SMS stored in the module file system).

### 23.2 Read Messages on-the-fly

TOBY-L2



Supported only by TOBY-L201 and MPC1-L201.

The messages can be stored only in the SIM ("SM" memory). Using Verizon MNO, some SIM could not allow the storing of SMS. In this case, the storing of SMS must be delegated to the DTE. To do this, the module must be instructed to send URCs for each message received, as in the following commands:

Command	Response	Description
AT+CMGF=1	OK	Set the preferred message format to text mode.
AT+CNMI=1, 2	OK	Enable the URC for each SMS received with the display of the message text.
	+UCMT: 1,+1231241241,"18:02:28+08",,,,2,,,,,6 Hello!	A new message is received from +1231241241 at 18:02:28+0 containing the text "Hello!".

## 23.3 Delete one single message or multiple messages

Command	Response	Description
AT+CMGF=1	OK	Set the preferred message format to text mode.
AT+CPMS?	+CPMS: "ME", 3, 300, "ME", 3, 300, "ME", 3, 300 OK	Check which memories are active for reading, deleting, storing, sending and receiving messages.
AT+CPMS="MT"	+CPMS: 5, 350, 3, 300, 3, 300 OK	Set the preferred message storage to "MT" (that means SIM card + module file system) for read and delete cases.
AT+CMGD=3	OK	Delete a single message from the module file system since the index is lower than 300 (number of SMS stored in the module file system).
AT+CMGD=302	OK	Delete a single message from the SIM card since the index is greater than 300 (number of SMS stored in the module file system).
AT+CMGL	+CMGL: 1, "REC READ", "12345", , "10/09/09, 15:06 :30+08" Test message 1 +CMGL: 2, "STO SENT", "67890", , abcdefghijklmnopqrstuvwxy +CMGL: 301, "REC READ", "54321", , "08/08/09, 10:01 :38+08" Hello world OK	Display the message list (both on the module file system and the SIM card) to check the remaining messages.
AT+CMGD=1,1	OK	Delete all the read messages, leaving unread and stored (whether sent or not) messages untouched.
AT+CMGL	+CMGL: 2, "STO SENT", "67890", , abcdefghijklmnopqrstuvwxy OK	Display the message list (both on the module file system and the SIM card) to check the remaining messages.

## 23.4 Write and/or send one single message

Command	Response	Description
AT+CMGF=1	OK	Set the preferred message format to text mode.
AT+CPMS?	+CPMS: "ME", 3, 300, "ME", 3, 300, "ME", 3, 300 OK	Check which memories are active for reading, deleting, storing, sending and receiving messages.
AT+CPMS="SM"	+CPMS: 3, 300, 0, 50, 3, 300 OK	Set the preferred message storage to "SM" (that means SIM card) for write and send cases.
AT+CMGW="12345"<CR> This is a test message<Ctrl-Z>	+CMGW: 301 OK	Store a new message (without sending it to the network) on the SIM card.
AT+CMSS=301	+CMSS: 5 OK	Send the message from SIM card since the index is greater than 300 (number of SMS stored in the module file system).
AT+CMGS="67890"<CR> Hello world<Ctrl-Z>	+CMGS: 6 OK	Directly send a new message without storing it.

## 23.5 Read all messages or one single message (concatenated SMS related commands)

LEON-G1

 Not supported by LEON-G100 / LEON-G200 "05" and previous versions.

Command	Response	Description
AT+CMGF=1	OK	Set the preferred message format to text mode.
AT+CPMS?	+CPMS: "ME",4,300,"ME",4,300,"ME",4,300 OK	Check which memories are active for reading, deleting, storing, sending and receiving messages.
AT+CPMS="MT"	+CPMS: 6,350,4,300,4,300 OK	Set the preferred message storage to "MT" (that means SIM card + module file system) for read and delete cases.
AT+UCMGL	+UCMGL: 1,"REC READ","12345",,"10/09/09,15:06:30+08" Test message 1 +UCMGL: 2,"STO SENT","67890",,,1,2,0,201 While some observers suggest the new plan shows government's determination to cool down the property market, several developers disagree, saying prices a +UCMGL: 3,"STO SENT","67890",,,2,2,0,201 re determined by the economy. +UCMGL: 4,"STO UNSENT",,",, Test message 2 +UCMGL: 301,"REC READ","54321",,"15/10/09,13:01:00+08",1,2,8,3840 The government will study whether the former chief executive of the West Kowloon Cultural District authority, Graham Sheffield, has breached his contrac +UCMGL: 302,"REC READ","54321",,"15/10/09,13:02:40+08",2,2,8,3840 t by taking up a new position at the British Council in London. OK	<p>Display the message list (both on the module file system and the SIM card).</p> <p>The messages of index 2 and 3 (stored on module file system) are the two parts of an "8-bit reference number" type concatenated SMS (they have the same reference number = 201).</p> <p>The messages of index 301 and 302 (stored on SIM card) are the two parts of an "16-bit reference number" type concatenated SMS (they have the same reference number = 3840).</p> <p> Also the +CMGL command shows all the SMS, parts of concatenated messages included, but there are no additional information about which of them are linked together.</p>
AT+UCMGR=302	+UCMGR: "REC READ","54321",,"15/10/09,13:02:40+08",2,2,8,3840 OK t by taking up a new position at the British Council in London. OK	<p>Read a single message from the SIM card.</p> <p>This is the part 2 of 2 of an "16-bit reference number" type concatenated SMS.</p>
AT+UCMGR=2	+UCMGR: "STO SENT","67890",1,2,0,201 While some observers suggest the new plan shows government's determination to cool down the property market, several developers disagree, saying prices a OK	<p>Read a single message from the module file system.</p> <p>This is the part 1 of 2 of an "8-bit reference number" type concatenated SMS.</p>

## 23.6 Write and/or send a concatenated SMS message

LEON-G1
SARA-G3

Not supported by LEON-G1 / LEON-G2 "05" and previous versions.

Command	Response	Description
AT+CMGF=1	OK	Set the preferred message format to text mode.
AT+CPMS?	+CPMS: "ME", 3, 300, "ME", 3, 300, "ME", 3, 300 OK	Check which memories are active for reading, deleting, storing, sending and receiving messages.
AT+CPMS="SM"	+CPMS: 3, 300, 0, 50, 3, 300 OK	Set the preferred message storage to "SM" (that means SIM card) for write and send cases.
AT+UCMGW="12345",,,1,3,0,25<CR> > He turned and ran up the steps to the highest point of his rocky islet, and climbed upon the stone platform he had built long ago. A quick look around sh<Ctrl-Z>	+UCMGW: 301 OK	Store (without sending it to the network) a new "8-bit reference number" type concatenated message (consisting of three parts) on the SIM card.  Actually all the parts need to be created separately.
AT+UCMGW="12345",,,2,3,0,25<CR> > owed only emptiness, save for the two smaller islets of the group, dim in the distance on either side. They bounded his world. Beyond them, and all aroun<Ctrl-Z>	+UCMGW: 302 OK	
AT+UCMGW="12345",,,3,3,0,25<CR> > d in the mist-haunted sea, nothing was visible, not even the horizon.<Ctrl-Z>	+UCMGW: 303 OK	
AT+CMSS=301	+CMSS: 10 OK	Send the concatenated message from storage (SIM card in this case).  All the parts need to be sent separately.
AT+CMSS=302	+CMSS: 11 OK	
AT+CMSS=303	+CMSS: 12 OK	
AT+UCMGS="67890",,1,2,8,1024<CR> > He turned and ran up the steps to the highest point of his rocky islet, and climbed upon the stone platform he had built long ago. A quick look around s<Ctrl-Z>	+UCMGS: 13 OK	Send directly a new "16-bit reference number" type concatenated message (consisting of two parts).  All the parts need to be sent separately.  The messages are only sent and not stored.
AT+UCMGS="67890",,2,2,8,1024<CR> > howed only emptiness, save for the two smaller islets of the group, dim in the distance on either side. <Ctrl-Z>	+UCMGS: 14 OK	

It is advised not to send new SMS short after the sending/reception of another SMS or right before a previous RRC Connection was released (i.e., through the ATH AT command). In these cases, in fact, RRC connection release and establish could create conflicts situations. The DTE should wait for the previous RRC connection to be released and then establish a new connection.

## 23.7 Message Acknowledgement

It is possible to acknowledge the reception of an SMS through the use of the +CNMA AT command. The following example refers to the delivering of an SMS from MS<sub>1</sub> to DUT<sub>1</sub>, with DUT<sub>1</sub> sending message acknowledgment to the sender after the reception of the +CMT URC. Note that the +CNMA AT command works only if it is issued shortly after the reception of the +CMT URC.

Command	Response	Description
(DUT <sub>1</sub> ) AT+CMEE=2	OK	Set the verbose error result codes.
(DUT <sub>1</sub> ) AT+CMGD=1, 4	OK	Clean SMS Memory on DUT <sub>1</sub>
(DUT <sub>1</sub> ) AT+CMGF=1	OK	Set the preferred message format to text mode.
(DUT <sub>1</sub> ) AT+CSMS=1	+CSMS: 1, 1, 1	Set Message Service #1, with AT command syntax compatible with 3GPP TS 27.005
(DUT <sub>1</sub> ) AT+CNMI=1, 2	OK	Set New Message Indication on DUT <sub>1</sub>
(DUT <sub>1</sub> ) AT+CNMA	+CMS ERROR: no +CNMA acknowledgement expected	No previous +CMT notifications, thus no acknowledgement to send.
(MS <sub>1</sub> ) AT+CMEE=2	OK	Set the verbose error result codes.
(MS <sub>1</sub> ) AT+CMGD=1, 4	OK	Clean SMS Memory on MS <sub>1</sub>
(MS <sub>1</sub> ) AT+CMGF=1	OK	Set the preferred message format to text mode.
(MS <sub>1</sub> ) AT+CSMS=1	+CSMS: 1, 1, 1 OK	Set Message Service #1, with AT command syntax compatible with 3GPP TS 27.005
(MS <sub>1</sub> ) AT+CNMI=1, 2	OK	Set New Message Indication on MS <sub>1</sub>
(MS <sub>1</sub> ) AT+CNMA	+CMS ERROR: no +CNMA acknowledgement expected	No previous +CMT notifications, thus no acknowledgement to send.
(MS <sub>1</sub> ) AT+CMGS="+393427761716" Hello World on Jun 19 at 08:55_ CTRL-Z	Hello World on Jun 19 at 08:55_ +CMGS: 13  OK	Send a message from MS to DUT <sub>1</sub>
(DUT <sub>1</sub> )	+CMT: "+393427761716",,"17/06/ 19,09:03:29+08" Hello World on Jun 19 at 08:55 +CMT: "+393427761716",,"17/06/ 19,09:03:29+08" Hello World on Jun 19 at 08:55	

Command	Response	Description
(DUT1) AT+CNMA	OK	Send Message Acknowledgement to the sender (MS <sub>i</sub> )
(DUT1) AT+CNMA	+CMS ERROR: network timeout	Network timeout to send the acknowledgement expired.

## 24 SIM lock AT command

LEON-G1

LISA-U2

SARA-G3

SARA-G4

SARA-U2

Not supported by LEON-G1/LEON-G2 "05" and previous versions.

### 24.1 SIM lock activation and deactivation

Command	Response	Description
AT+CMEE=2	OK	Set the verbose error result codes.
AT+USIMLCK=?	+USIMLCK: ("PN", "PU", "PS"), "", " ", (0-1) OK	Allowed SIM locks.
AT+CPIN="1234"	OK	Set the PIN.
AT+CLCK="PN", 2	+CLCK: 0 OK	Check the SIM lock status; the network facility is not enabled.
AT+USIMLCK="PN", "123.45", "12345678", 1	OK	Feature configured and enabled.
AT+CLCK="PN", 2	+CLCK: 1 OK	Check the SIM lock status; the network facility is enabled.
AT+CLCK="PN", 0, "12345678"	OK	Verify and de-active the personalization.
AT+CLCK="PN", 2	+CLCK: 0 OK	Check the SIM lock status; the network facility is not enabled.

### 24.2 SIM lock enabling and activation

Command	Response	Description
AT+CMEE=2	OK	Set the verbose error result codes.
AT+USIMLCK=?	+USIMLCK: ("PN", "PU", "PS"), "", " ", (0-1) OK	Allowed SIM locks.
AT+CPIN="1234"	OK	Set the PIN.
AT+CLCK="PN", 2	+CLCK: 0 OK	Check the SIM lock status; the network facility is not enabled.
AT+USIMLCK="PN", "123.45", "12345678", 0	OK	Feature configured but disabled.
AT+CLCK="PN", 2	+CLCK: 0 OK	Check the SIM lock status; the network facility is not enabled.
AT+CLCK="PN", 1, "12345678"	OK	Activation of the personalization.
AT+CLCK="PN", 2	+CLCK: 1 OK	Check the SIM lock status; the network facility is enabled.



## 25 SIM Access Profile (SAP) AT commands

LISA-U2

SARA-U2

TOBY-L2

 Not supported by LISA-U200 "00" version.

SAP AT commands enable the u-blox modules to connect to an SAP server and exchange data with the SIM provided by the server, as if it is locally attached to the u-blox cellular module. Once the connection to an SAP server is established and negotiated, the u-blox module performs a detach operation from the local SIM in the SIM card holder connected to the module, followed by an attach operation to the remote SIM. From this time on, any operation of the u-blox module is routed to the remotely attached SIM. With the SAP deactivation, the module performs a detach operation from the remote SIM followed by an attach operation to the local one (if present).

 For more details on SAP implementation, see the module system integration manual [\[6\]](#), [\[7\]](#), [\[11\]](#).

### 25.1 SAP activation

Command	Response	Description
AT+CMEE=2	OK	Set the verbose error result codes.
AT+USAPIND=1	OK	Enable the URC for the SAP mode status change indication and remote SIM status change indication.
		Enable the "SIM card detection" and "SIM hot insertion/removal" functions via AT commands (for more details see u-blox AT Commands Manual <a href="#">[1]</a> , +UGPIOC, +UDCONF=50 AT commands), to enable the URCs for local insertion/removal actions of the local SIM.
AT+USAPMODE=?	+USAPMODE: (0-1),0,(0-65535) OK	Allowed SAP modes and parameters.
AT+USAPMODE=1	OK	Start the SAP negotiation with server.
	+UUSAPMODE: 1	URC signaling SAP client connected to server.
	+UUSAPREMOTE: 1	URC signaling remote SIM present. The local SIM (if present) is detached. The remote SIM is attached: any following operations are routed to the attached remote SIM.
AT+USAPMODE?	+USAPMODE: 1 OK	The SAP client mode is active.
AT+CPIN?	+CPIN: SIM PIN	Check the PIN status of the remote SIM.
AT+CPIN="1234"	OK	Set the PIN of the remote SIM.
AT+CPIN?	+CPIN: READY OK	Remote SIM authenticated and ready to use.
AT+COPS?	+COPS: 0,0,"vodafone IT",0 OK	Network registration status with attached remote SIM.
ATD+3933812345678;	OK	Place a voice call using attached the remote SIM.
	+UUSAPLOCAL: 1	A local SIM is inserted in the SIM card holder connected to the module. Because a SAP session is running, the module operations are routed to the attached remote SIM.
	+UUSAPLOCAL: 0	The local SIM is removed from the SIM card holder connected to the module. Because a SAP session is running, the module operations are routed to the attached remote SIM.

## 25.2 SAP deactivation

Command	Response	Description
AT+CMEE=2	OK	Set the verbose error result codes.
AT+USAPIND=1	OK	Enable the URC generation for the SAP mode status change indication.
AT+USAPMODE=0	OK	Stop the SAP connection with server.
	+UUSAPMODE: 0	A URC indicates the SAP client is disconnected from the server. The remote SIM is detached; the local SIM (if present) is attached; any following operations are routed to the attached local SIM.
AT+USAPMODE?	+USAPMODE: 0 OK	The SAP connection is terminated.
AT+CPIN?	+CME ERROR: SIM not inserted	Local SIM not present.
AT+COPS?	+COPS: 0 OK	Module not registered to the network.
ATD+3933812345678;	+CME ERROR: SIM not inserted	Unable to place call because the local SIM not present.
AT+USAPIND=0	OK	Disable the URC generation for the SAP mode status change indication.

## 26 USB profile configuration

TOBY-L2

Each u-blox cellular module consists of one or more USB products from the point of view of the USB configuration context. Each USB product includes a certain number of USB profiles. Each USB profile includes a certain number of USB endpoints, depending on the overall USB functions of the USB profile.

The USB profile switch is not performed at run-time. The settings are saved in the NVM at the module power off; the new configuration will be effective at the subsequent module reboot.

The USB profile can be configured through +UUSBCONF AT command.

### 26.1 High throughput profile

This is the default configuration (<id>=3), and it should be used to reach the best performance. The interfaces available are:

- 1 RNDIS for Ethernet-over-USB
- 1 CDC-ACM for AT command and data

This configuration is identified by:

- VID = 0x1546
- PID = 0x1146

Command	Response	Description
AT+UUSBCONF=3,"RNDIS",0	OK	Set USB configuration to "High throughput" and disable the audio over USB.
AT+UUSBCONF?	+UUSBCONF: 0,"",,"0x1141" OK	The new configuration is applied only at next module reboot. This is the current configuration.
AT+CFUN=16	OK	Reboot the module to make effective the changes.
AT+UUSBCONF?	+UUSBCONF: 3,"RNDIS",,"0x1146" OK	Check that the new configuration has been applied.

### 26.2 Fairly back-compatible profile

This is the configuration (<id>=0) similar to the one implemented in the u-blox LISA-U2 series. The interfaces available are:

- 3 CDC-ACM for AT command and data
- 1 CDC-ACM for GNSS tunneling
- 1 CDC-ACM for SIM Access profile (SAP)
- 1 CDC-ACM for diagnostic

This configuration is identified by:

- VID = 0x1546
- PID = 0x1141

Command	Response	Description
AT+UUSBCONF=0,"",0	OK	Set USB configuration to "fairly back-compatible" and disable the audio over USB.

Command	Response	Description
AT+UUSBCONF?	+UUSBCONF: 3, "RNDIS", , "0x1146" OK	The new configuration is applied only at next module reboot. This is the current configuration.
AT+CFUN=16	OK	Reboot the module to make effective the changes.
AT+UUSBCONF?	+UUSBCONF: 0, "", , "0x1141" OK	Check that the new configuration has been applied.

## 26.3 Low/Medium throughput profile

In this configuration (<id>=2) the presence of several USB functions limits the reachable data transfer throughput. The interfaces available are:

- 3 CDC-ACM for AT command and data
- 1 CDC-ECM for Ethernet-over-USB

This configuration is identified by:

- VID = 0x1546
- PID = 0x1143

Command	Response	Description
AT+UUSBCONF=2, "ECM", 0	OK	Set USB configuration to "low/medium throughput" and disable the audio over USB.
AT+UUSBCONF?	+UUSBCONF: 0, "", , "0x1141" OK	The new configuration is applied only at next module reboot. This the current configuration.
AT+CFUN=16	OK	Reboot the module to make effective the changes.
AT+UUSBCONF?	+UUSBCONF: 2, "ECM", , "0x1143" OK	Check that the new configuration has been applied.

# Appendix

## A Glossary

Abbreviation	Definition
3GPP	3rd Generation Partnership Project
ADC	Analog to Digital Converter
APN	Access Point Name
AT	AT Command Interpreter Software Subsystem, or attention
CI	Cell Identity
CTS	Clear To Send
DLC	Data Link Connection
DM	Device Management
DNS	Domain Name System
DTE	Data Terminal Equipment
DUT	Device Under Test
EDGE	Enhanced Data rates for GSM Evolution
EHPLMN	Equivalent Home PLMN
EPLMN	Equivalent PLMN
EPS	Evolved Packet System
FTP	File Transfer Protocol
GNSS	Global Navigation Satellite System
GPIO	General Purpose Input Output
GPRS	General Packet Radio Service
GSM	Global System for Mobile Communication
HPLMN	Home PLMN
HSDPA	High Speed Downlink Packet Access
HTTP	HyperText Transfer Protocol
I <sup>2</sup> C	Inter-Integrated Circuit
IMEI	International Mobile Equipment Identity
IMSI	International Mobile Station Identity
IP	Internet Protocol
LAC	Location Area Code
MCC	Mobile Country Code
MNC	Mobile Network Code
MT	Mobile Terminal
NVM	Non Volatile Memory
ODIS	OMA-DM IMEI Sync
OMA-DM	Open Mobile Alliance Device Management
PDP	Parallel Data Processing
PIN	Personal Identification Number
PLMN	Public Land Mobile Network
RAT	Radio Access Technology
RTS	Request To Send
SAT	SIM Application Toolkit
SIM	Subscriber Identification Module
SV	Satellite in View
SMTP	Simple Mail Transfer Protocol
TA	Timing Advance
TCP	Transmission Control Protocol
TTF	Time To First Fix
UDP	User Datagram Protocol

Abbreviation	Definition
UMTS	Universal Mobile Telecommunications System
URC	Unsolicited Result Code
URL	Uniform Resource Locator
VPLMN	Visited PLMN
WCDMA	Wideband CODE Division Multiple Access

**Table 1: Explanation of the abbreviations and terms used**

## Related documents

- [1] u-blox AT Commands Manual, Doc. No. [UBX-13002752](#)
- [2] 3GPP TS 27.010 - Terminal Equipment to User Equipment (TE-UE) multiplexer protocol (Release 1999)
- [3] LEON-G100/LEON-G200 System Integration Manual, Doc. No. [UBX-13002023](#) (until end 2013, GSM.G1-HW-09002)
- [4] 3GPP TS 51.011 - Specification of the Subscriber Identity Module - Mobile Equipment (SIM-ME) interface
- [5] 3GPP TS 51.014 - Specification of the SIM Application Toolkit for the Subscriber Identity Module - Mobile Equipment (SIM - ME) interface)
- [6] LISA-U1 / LISA-U2 series System Integration Manual, Doc. No. [UBX-13001118](#)
- [7] SARA-G3 / SARA-U2 series System Integration Manual, Doc. No. [UBX-13000995](#)
- [8] 3GPP TS 31.111 - Universal Subscriber Identity Module (USIM) Application Toolkit (USAT) (Release 10)
- [9] ETSI 102.223 - Card Application Toolkit (CAT)
- [10] 3GPP TS 31.102 - Characteristics of the Universal Subscriber Identity Module (USIM) application (Release 7)
- [11] TOBY-L2 / MPC1-L2 series System Integration Manual, Doc. No. [UBX-13004618](#)
- [12] u-blox TOBY-L2 series Networking Modes Application Note, Doc. No. [UBX-14000479](#)
- [13] u-blox Cellular Modules Firmware Update Application Note, Doc. No. [UBX-13001845](#)
- [14] OMA Device Management V1.2.1 (<http://technical.openmobilealliance.org/Technical/technical-information/release-program/current-releases/dm-v1-2-1>)
- [15] AT&T Device Requirements, Doc. No. 13340
- [16] 3GPP TS 31.102 - Characteristics of the Universal Subscriber Identity Module (USIM) application
- [17] SARA-G4 System Integration Manual, Doc. No. [UBX-18046432](#)
- [18] TOBY-R2 series System Integration Manual, Doc. No. [UBX-16010572](#)
- [19] LARA-R2 series System Integration Manual, Doc. No. [UBX-16010573](#)

 For regular updates to u-blox documentation and to receive product change notifications, register on our homepage ([www.u-blox.com](http://www.u-blox.com)).

## Revision history

Revision	Date	Name	Status / Comments
-	28-Jun-2011	lpah	Document replaces GSM.G1-CS-09003-C2 Added LISA-U1 LISA-H1 series; Added examples on SMS and SIM Lock AT commands
1	29-Jul-2011	lpah	Removed LISA-H1 series
2	20-Jan-2012	lpah	Extended to include LISA-U2 series and LISA-U1x0-01S module versions
3	28-Jun-2012	wcos	Added SAP AT commands examples
4	22-Apr-2013	lpah	Extended to include SARA-G350 series (Last revision with docu number WLS-CS-11003)
A	29-Jul-2013	mrod / fgue	Extended to include SARA-G300 / SARA-G310 series
R07	23-Jul-2014	lpah	Extended to include SARA-U2 series Added AT command response parser and Network registration flow-chart sections
R08	06-Mar-2015	mace	Extended to include TOBY-L2 / MPC1-L2 series
R09	17-Jul-2015	mace	Added +UMNOCONF, +UMNOPLMN examples
R10	04-Apr-2016	amat / msin / fdil / lchi	Extended 4G and tri-mode configuration to +UCELLOCK command. Restyle of the bridge configuration. Extended the section about HTTP secure option. Updated the HTTP examples with a new different server httpbin which provides HTTP client testing services.
R11	22-Sep-2016	mtom / mace	Added secondary PDP context definition and ODIS examples
R12	31-Jul-2018	mace	Extended document applicability to TOBY-R2 / LARA-R2 series
R13	27-May-2019	fvid	Extended document applicability to SARA-G4 series



# Contact

For complete contact information, visit us at [www.u-blox.com](http://www.u-blox.com).

## u-blox Offices

### North, Central and South America

#### u-blox America, Inc.

Phone: +1 703 483 3180  
E-mail: [info\\_us@u-blox.com](mailto:info_us@u-blox.com)

#### Regional Office West Coast:

Phone: +1 408 573 3640  
E-mail: [info\\_us@u-blox.com](mailto:info_us@u-blox.com)

#### Technical Support:

Phone: +1 703 483 3185  
E-mail: [support@u-blox.com](mailto:support@u-blox.com)

### Headquarters

#### Europe, Middle East, Africa

#### u-blox AG

Phone: +41 44 722 74 44  
E-mail: [info@u-blox.com](mailto:info@u-blox.com)  
Support: [support@u-blox.com](mailto:support@u-blox.com)

### Asia, Australia, Pacific

#### u-blox Singapore Pte. Ltd.

Phone: +65 6734 3811  
E-mail: [info\\_ap@u-blox.com](mailto:info_ap@u-blox.com)  
Support: [support\\_ap@u-blox.com](mailto:support_ap@u-blox.com)

#### Regional Office Australia:

Phone: +61 2 8448 2016  
E-mail: [info\\_anz@u-blox.com](mailto:info_anz@u-blox.com)  
Support: [support\\_ap@u-blox.com](mailto:support_ap@u-blox.com)

#### Regional Office China (Beijing):

Phone: +86 10 68 133 545  
E-mail: [info\\_cn@u-blox.com](mailto:info_cn@u-blox.com)  
Support: [support\\_cn@u-blox.com](mailto:support_cn@u-blox.com)

#### Regional Office China (Chongqing):

Phone: +86 23 6815 1588  
E-mail: [info\\_cn@u-blox.com](mailto:info_cn@u-blox.com)  
Support: [support\\_cn@u-blox.com](mailto:support_cn@u-blox.com)

#### Regional Office China (Shanghai):

Phone: +86 21 6090 4832  
E-mail: [info\\_cn@u-blox.com](mailto:info_cn@u-blox.com)  
Support: [support\\_cn@u-blox.com](mailto:support_cn@u-blox.com)

#### Regional Office China (Shenzhen):

Phone: +86 755 8627 1083  
E-mail: [info\\_cn@u-blox.com](mailto:info_cn@u-blox.com)  
Support: [support\\_cn@u-blox.com](mailto:support_cn@u-blox.com)

#### Regional Office India:

Phone: +91 80 405 092 00  
E-mail: [info\\_in@u-blox.com](mailto:info_in@u-blox.com)  
Support: [support\\_in@u-blox.com](mailto:support_in@u-blox.com)

#### Regional Office Japan (Osaka):

Phone: +81 6 6941 3660  
E-mail: [info\\_jp@u-blox.com](mailto:info_jp@u-blox.com)  
Support: [support\\_jp@u-blox.com](mailto:support_jp@u-blox.com)

#### Regional Office Japan (Tokyo):

Phone: +81 3 5775 3850  
E-mail: [info\\_jp@u-blox.com](mailto:info_jp@u-blox.com)  
Support: [support\\_jp@u-blox.com](mailto:support_jp@u-blox.com)

#### Regional Office Korea:

Phone: +82 2 542 0861  
E-mail: [info\\_kr@u-blox.com](mailto:info_kr@u-blox.com)  
Support: [support\\_kr@u-blox.com](mailto:support_kr@u-blox.com)

#### Regional Office Taiwan:

Phone: +886 2 2657 1090  
E-mail: [info\\_tw@u-blox.com](mailto:info_tw@u-blox.com)  
Support: [support\\_tw@u-blox.com](mailto:support_tw@u-blox.com)