

Cinterion[®] ELS31-V

AT Command Set

Version: 4.3.2.0-25421
DocId: ELS31-V_ATC_V4.3.2.0-25421

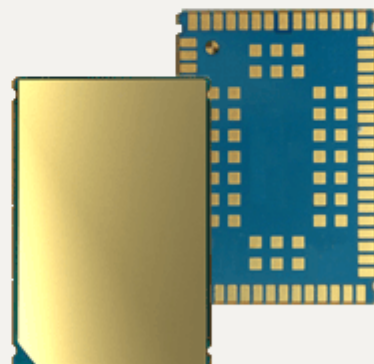

Document Name: **Cinterion® ELS31-V AT Command Set**

Version: **4.3.2.0-25421**

Date: **October 11, 2016**

DocId: **ELS31-V_ATC_V4.3.2.0-25421**

Status **Confidential / Preliminary**

GENERAL NOTE

THE USE OF THE PRODUCT INCLUDING THE SOFTWARE AND DOCUMENTATION (THE "PRODUCT") IS SUBJECT TO THE RELEASE NOTE PROVIDED TOGETHER WITH PRODUCT. IN ANY EVENT THE PROVISIONS OF THE RELEASE NOTE SHALL PREVAIL. THIS DOCUMENT CONTAINS INFORMATION ON GEMALTO M2M PRODUCTS. THE SPECIFICATIONS IN THIS DOCUMENT ARE SUBJECT TO CHANGE AT DISCRETION OF GEMALTO M2M. GEMALTO M2M GMBH GRANTS A NON-EXCLUSIVE RIGHT TO USE THE PRODUCT. THE RECIPIENT SHALL NOT TRANSFER, COPY, MODIFY, TRANSLATE, REVERSE ENGINEER, CREATE DERIVATIVE WORKS; DISASSEMBLE OR DECOMPILE THE PRODUCT OR OTHERWISE USE THE PRODUCT EXCEPT AS SPECIFICALLY AUTHORIZED. THE PRODUCT AND THIS DOCUMENT ARE PROVIDED ON AN "AS IS" BASIS ONLY AND MAY CONTAIN DEFICIENCIES OR INADEQUACIES. TO THE MAXIMUM EXTENT PERMITTED BY APPLICABLE LAW, GEMALTO M2M GMBH DISCLAIMS ALL WARRANTIES AND LIABILITIES. THE RECIPIENT UNDERTAKES FOR AN UNLIMITED PERIOD OF TIME TO OBSERVE SECRECY REGARDING ANY INFORMATION AND DATA PROVIDED TO HIM IN THE CONTEXT OF THE DELIVERY OF THE PRODUCT. THIS GENERAL NOTE SHALL BE GOVERNED AND CONSTRUED ACCORDING TO GERMAN LAW.

Copyright

Transmittal, reproduction, dissemination and/or editing of this document as well as utilization of its contents and communication thereof to others without express authorization are prohibited. Offenders will be held liable for payment of damages. All rights created by patent grant or registration of a utility model or design patent are reserved.

Copyright © 2016, Gemalto M2M GmbH, Gemalto Company

Trademark Notice

Gemalto, the Gemalto logo, are trademarks and service marks of Gemalto and are registered in certain countries.

Microsoft and Windows are either registered trademarks or trademarks of Microsoft Corporation in the United States and/or other countries. All other registered trademarks or trademarks mentioned in this document are property of their respective owners.

Contents

1.	Introduction.....	10
1.1	Scope of the document	10
1.2	Related documents	11
1.3	Document Conventions	13
1.3.1	Quick Reference Table	13
1.3.2	Superscript notation for parameters and values	14
1.4	AT Command Syntax	15
1.4.1	Using Parameters	15
1.4.2	Concatenating AT Commands.....	15
1.5	Communication between Customer Application and ELS31-V	17
1.6	Supported character sets	18
1.6.1	GSM alphabet tables and UCS2 character values	20
1.6.2	UCS2 and GSM character coding and conversion	22
1.6.2.1	Output of SIM data (UE to TE).....	22
1.6.2.2	Input of SIM data (TE to UE)	23
1.7	Unsolicited Result Code Presentation.....	24
1.7.1	Common URCs.....	24
1.8	Errors and Messages	25
2.	Configuration Commands.....	26
2.1	AT&F Reset AT Command Settings to Factory Default Values	26
2.2	AT&V Display current configuration	27
2.2.1	AT&V responses.....	28
2.3	AT&W Store AT Command Settings to User Defined Profile	29
2.4	ATQ Result Code Presentation Mode	30
2.5	ATV Result code format mode	31
2.5.1	Verbose and numeric result codes	31
2.6	ATZ Restore AT Command Settings from User Defined Profile	32
2.7	AT+CFUN Functionality Level.....	33
2.8	AT^SMSO Switch Off ELS31-V.....	35
2.9	AT+CMEE Error Message Format	36
2.9.1	CME/CMS Error Code Overview	37
2.10	AT+CSCS Character Set	41
2.11	AT^SCFG Extended Configuration Settings	42
2.12	AT^SPOW Set UART Mode and SLEEP Mode on UART	60
3.	Status Control Commands	62
3.1	AT+CEER Extended Error Report.....	62
3.1.1	Release Causes for EMM Failures	63
3.1.2	Release Causes for ESM Failures.....	63
3.2	AT^SIND Extended Indicator Control.....	64
3.3	AT+CPAS Activity Status	69
3.4	AT+WS46 Select wireless network	70
4.	Serial Interface Control Commands.....	71
4.1	ATIQ Flow Control.....	71
4.2	AT&C Set Data Carrier Detect (DCD) Line Mode	72

4.3	AT&D Set Data Terminal Ready (DTR) Line Mode	73
4.4	AT&S Set Data Set Ready (DSR) Line Mode	74
4.5	ATE AT Command Echo	75
4.6	AT+ICF Character Framing	76
4.7	AT+IPR Bit Rate	78
5.	Identification Commands.....	80
5.1	ATI Display product identification information	80
5.2	AT+CGMI Request manufacturer identification	82
5.3	AT+CGMM Request model identification	83
5.4	AT+CGMR Request revision identification of software status.....	84
5.5	AT+CGSN Request International Mobile Equipment Identity (IMEI).....	85
5.6	AT+GSN Request International Mobile Equipment Identity (IMEI)	87
5.7	AT+CIMI Request International Mobile Subscriber Identity (IMSI).....	89
6.	Security Commands	90
6.1	AT+CPIN PIN Authentication	90
6.2	AT+CPINR Remaining PIN Entries	92
6.3	AT+CLCK Facility lock	94
6.4	AT+CPWD Change Password	97
7.	Call related Commands.....	99
7.1	ATH Disconnect existing connection.....	99
7.2	ATO Switch from command mode to data mode / PPP online mode.....	100
7.3	+++ Switch from data mode or PPP online mode to command mode	101
8.	Network Service Commands	102
8.1	AT+COPN Read operator names	102
8.2	AT+COPS Operator Selection	103
8.3	AT+CESQ Extended Signal Quality	106
8.4	AT+CPOL Preferred Operator List	108
8.5	AT+CPLS Select Preferred Operator List	110
8.6	AT+CTZR Time Zone Reporting	111
8.7	AT+CTZU Automatic Time Zone Update	113
8.8	AT^SMONI Monitoring Serving Cell	114
8.8.1	AT^SMONI Responses.....	114
8.8.2	Service states	115
8.9	AT^SMONP Monitoring Neighbour Cells	117
8.9.1	AT^SMONP Responses	117
8.9.2	AT^SMONP Enhanced Responses	118
8.10	AT^SNMON Network Monitoring.....	120
9.	Internet Service Commands	122
9.1	AT^SICA Internet Connection Activate or Deactivate	126
9.2	AT^SICS Internet Connection Settings	127
9.3	AT^SIPS Internet Profile Storage	129
9.4	AT^SISS Internet Service Setup Profile	130
9.5	AT^SISI Internet Service Information	138
9.6	AT^SISO Internet Service Open	140
9.7	AT^SISC Internet Service Close	143
9.8	AT^SISR Internet Service Read Data	144

9.8.1	Example: Socket Host Reads Small Amounts of UDP Data Packets (URC Mode).....	146
9.9	AT^SISW Internet Service Write Data.....	147
9.9.1	Usage of parameter <eodFlag>.....	149
9.10	AT^SIST Enter Transparent Mode.....	150
9.11	AT^SISH Disconnect Remote Client.....	152
9.12	AT^SISX Internet Service Execution.....	153
9.13	AT^SISE Internet Service Error Report.....	156
9.14	Internet Service URC "^SIS".....	157
9.14.1	Information Elements Related to the Service Application.....	158
9.14.2	Information Elements Related to FTP Service.....	161
9.14.3	Information Elements Related to HTTP Service.....	161
9.14.4	Information Elements Related to SMTP Service.....	162
9.15	Examples of how to Configure and Use Internet Service Profiles.....	163
9.15.1	Selecting URC Mode or Polling Mode.....	163
9.15.2	Configuring an Internet Connection Profile.....	163
9.15.3	Configuring Non-Transparent Listener.....	163
9.15.4	Configuring TCP Client for Calling a TCP Listener.....	164
9.15.5	Transparent TCP Listener: Accepting / Rejecting Incoming Remote Client.....	164
9.15.6	Transparent TCP Listener: Autoanswering Incoming Remote Client.....	166
9.15.7	Socket Client Sends Data via TCP Connection (Polling Mode).....	167
9.15.8	Socket Client Sends Data via TCP Connection with URCs.....	167
9.15.9	UDP Scenario.....	168
9.15.10	Creating Transparent TCP Socket Client.....	170
9.15.11	Opening and Closing Transparent TCP Service.....	170
9.15.12	Transparent TCP Client Receives Data While in AT Command Mode.....	171
9.15.13	Remote Server Disconnects While Transparent TCP Service is in Transparent Access Mode.....	172
9.15.14	Server Disconnects While Transparent TCP Service is in AT Command Mode and Data is Pending.....	172
9.15.15	FTP Upload Single File (URC Mode).....	174
9.15.16	HTTP Download Using TLS.....	175
9.15.17	HTTP Post.....	175
9.15.18	Ping.....	176
9.15.19	Resolving DNS Host Name to IP Address.....	177
10.	Packet Domain Related Commands.....	178
10.1	AT+CGACT PDP context activate or deactivate.....	178
10.2	AT+CGATT GPRS attach or detach.....	180
10.3	AT+CGDCONT Define PDP Context.....	181
10.3.1	Attaching to LTE Networks.....	183
10.4	AT+CGDSCONT Define Secondary PDP Context.....	184
10.5	AT+CGCMOD PDP Context Modify.....	186
10.6	AT+CEREG EPS Network Registration Status.....	187
10.7	AT+CGEREP Packet Domain Event Reporting.....	189
10.8	AT+CGPADDR Show PDP Address.....	192
10.9	AT+CGPIAF Select Printing IP address format.....	194
10.10	AT+CGEQOS Define EPS Quality of Service.....	196
10.11	AT+CGEQOSRDP EPS Quality of Service Read Dynamic Parameters.....	198
10.12	AT+CGCONTRDP PDP context read dynamic parameters.....	200
10.13	AT+CGSCONTRDP Secondary PDP Context Read Dynamic Parameters.....	202

10.14	AT+CGTFT Traffic Flow Template	203
10.15	AT+CGTFTRDP Traffic Flow Template Read Dynamic Parameters	206
10.16	AT+CGAUTH Define PDP Context Authentication Parameters	209
10.17	AT+CGDATA Enter data state	211
10.17.1	Automatic deactivation of PDP context during dial-up PPP	212
10.18	AT+CGSMS Select Service for MO Short messages	213
10.19	ATD*99# Request Packet Domain Service	214
11.	Short Message Service (SMS) Commands.....	215
11.1	SMS Parameters	215
11.2	AT+CMGC Send SMS Command	219
11.3	AT+CMGD Delete short message	220
11.4	AT+CMGF Select SMS message format	221
11.5	AT+CMGL List SMS messages from preferred store	222
11.6	AT+CMGR Read SMS messages	224
11.7	AT+CMGS Send SMS	226
11.8	AT+CMGW Write Short Messages to Memory	227
11.9	AT+CMMS More Messages to Send	229
11.10	AT+CMSS Send short messages from storage	230
11.11	AT+CNMA New Message Acknowledgement to UE/TE	231
11.12	AT+CNMI SMS Event Reporting Configuration	232
11.13	AT+CPMS Preferred SMS message storage	235
11.14	AT+CSCA SMS Service Center Address	237
11.15	AT+CSDH Show SMS text mode parameters	238
11.16	AT+CSMP Set SMS Text Mode Parameters	239
11.17	AT+CSMS Select Message Service	241
11.18	AT^SMGL List Short Messages from preferred store without setting status to REC READ	243
11.19	AT^SMGR Read short message without setting status to REC READ	244
11.20	AT^SMGSIMS Send 3GPP2 SMS over IMS	245
11.21	AT^SMGRIMS Read 3GPP2 SMS over IMS	247
11.22	AT^SMGLIMS List 3GPP2 SMS over IMS	248
11.23	AT^SMGDIMS Delete 3GPP2 SMS over IMS	249
11.24	AT^SIMSCFGSMS Configure 3GPP2 SMS over IMS	250
12.	(U)SIM related Commands	252
12.1	AT+CCID (U)SIM Card Identification Number	252
12.2	AT+CRSM Restricted SIM Access	254
12.3	AT+CSIM Generic (U)SIM Access	256
13.	(U)SIM Application Toolkit (SAT) Commands.....	257
13.1	AT^SSTA Remote-SAT Interface Activation	259
13.2	AT+STKPRO SAT Proactive Command URCs	261
13.3	AT+STKTR SAT Terminal Response Commands	267
13.4	AT+STKENV SAT Envelope Command	272
13.5	AT+STKCC SAT Call Control Notification	274
13.6	AT+STKCNF SAT Proactive Session Status	275
13.7	Examples of how to Configure and Use the SAT	276
14.	Phonebook Commands.....	278
14.1	AT+CNUM Read own numbers	278

15. Miscellaneous Commands.....	279
15.1 A/ Repeat Previous Command Line.....	279
15.2 ATS3 Command Line Termination.....	280
15.3 ATS4 Response Formatting.....	281
15.4 ATS5 Command Line Editing.....	282
15.5 AT^SBNR Binary Read.....	283
15.6 AT^SBNW Binary Write.....	285
15.7 AT^SFDL Firmware Download.....	287
16. Hardware related Commands.....	288
16.1 AT+CCLK Real Time Clock.....	288
16.2 AT^SBV Battery/Supply Voltage.....	290
16.3 AT^SCTM Critical Operating Temperature Monitoring.....	291
16.4 AT^SLED LED Feature.....	293
16.5 AT^SRADC Configure and Read ADC Measurement.....	295
16.6 AT^SSPI Serial Protocol Interface.....	298
16.6.1 Selecting SPI Mode.....	300
16.6.2 Transmitting Data over AT Interface.....	301
16.6.2.1 Structure of Messages on the I ² C Bus.....	302
16.6.2.2 Structure of Messages on the SPI.....	303
16.6.3 Error Handling on the I ² C Bus.....	303
16.6.4 Example: Using I ² C Bus.....	305
16.6.5 Example: Transfer and Response Messages on SPI.....	306
17. General Purpose I/O (GPIO) Pin related Commands.....	307
17.1 AT^SCPIN Pin Configuration.....	307
17.1.1 GPIO Configuration Table.....	308
17.2 AT^SGIO Get IO State of a Specified Pin.....	310
17.3 AT^SSIO Set IO State of a Specified Pin.....	311
17.4 AT^SSCNT Start and Stop Pulse Counter.....	312
17.4.1 Using the Pulse Counter in Start-Stop Counter Mode.....	313
17.5 AT^SCCNT Configure Pulse Counter.....	314
17.5.1 Using the Pulse Counter in Limit Counter Mode.....	315
17.6 AT^SPIO GPIO Driver Open/Close.....	316
18. Appendix.....	317
18.1 Available AT Commands and Dependency on SIM PIN.....	317
18.2 Availability of AT Commands Depending on Operating Mode of ME.....	322
18.3 AT Command Settings storable with AT&W.....	326
18.4 Factory Default Settings Restorable with AT&F.....	327
18.5 Summary of Unsolicited Result Codes (URC).....	328
18.6 Alphabetical List of AT Commands.....	331

List of Tables

Table 1.1:	Symbols used to mark the type of parameters	14
Table 1.2:	Symbols used to indicate storage options or correlations with other commands	14
Table 1.3:	Symbols used to mark different types of default values of parameters	14
Table 1.4:	Types of AT commands and responses	15
Table 1.5:	Exemplary escape sequences generated by ELS31-V for its non-UCS2 output	19
Table 2.1:	General "CME ERROR" Codes (3GPP TS 27.007)	37
Table 2.2:	EPS related "CME ERROR" Codes (3GPP TS 27.007)	38
Table 2.3:	SMS related "CMS ERROR" Codes (3GPP TS 27.005)	38
Table 9.1:	Applicability of <code>AT^SICS <conParmTag></code> values	127
Table 9.2:	Applicability of <code>AT^SISS <srvParmTag></code> values	130
Table 16.1:	ELS31-V Status and Mode Indication via LED	293
Table 16.2:	Special characters for ASCII coding	301
Table 16.3:	Structure of Transfer and Response Messages on the I ² C bus	302
Table 16.4:	Structure of Transfer and Response Messages for SPI	303
Table 18.1:	Available AT Commands and Dependency on SIM PIN	317
Table 18.2:	Availability of AT Commands Depending on Operating Mode of ME	322
Table 18.3:	Settings Stored to User Profile on ASC0	326
Table 18.4:	Factory Default Settings Restorable with AT&F	327
Table 18.5:	Summary of Unsolicited Result Codes (URC)	328
Table 18.6:	Alphabetical List of AT Commands	331

List of Figures

Figure 1.1:	Main character table of GSM 7 bit default alphabet.....	20
Figure 1.2:	Extension character table of GSM 7 bit default alphabet.....	21
Figure 13.1:	Remote-SAT Context Diagram	258
Figure 16.1:	SPI modes selectable on SPI	300

1. Introduction

1.1 Scope of the document

This document presents the AT Command Set for
ELS31-V LTE Engine, Release 4.3.2.0-25421.

Before using the ELS31-V or upgrading to a new firmware version please read the latest product information provided in "[ELS31-V Release Notes, Version 4.3.2.0-25421](#)".

More information is available at <http://m2m.gemalto.com/>.

DISCLAIMER:

AT commands or parameters not documented in this document are subject to change and reserved for future use. Gemalto M2M GmbH reserves the right to modify or even eliminate these options in later releases.

ELS31-V features packet switched (PS) data capability, but does not support circuit switched (CS) data transmission. However, for reasons of compatibility with other products, and for compliance with 3GPP TS specifications, some AT commands imply parameters or values related to CS data capability.

1.2 Related documents

1.2 Related documents

- [1] ELS31-V Release Notes, Version 4.3.2.0-25421
- [2] ELS31-V Hardware Interface Description, Version 4.3.2.0-25421
- [3] Application Note 16: Updating ELS31-V Firmware
- [4] Application Note 62: Transport Layer Security for Client TCP/IP Services
- [5] [3GPP TR 21.905](#) (descendant of 3GPP TR 01.04): Vocabulary for 3GPP Specifications
- [6] International Organization for Standardization (ISO): [ISO/IEC10646](#): Universal Multiple-Octet Coded Character Set (UCS) - Part 1: Architecture and Basic Multilingual Plane.
This international standard is [closely related](#) to the [Unicode Standard](#) published by the [Unicode Consortium](#)
- [7] The [Unicode Consortium](#): [Mapping of ETSI GSM 03.38 7-bit default alphabet characters into Unicode \[TXT\]](#)
- [8] [ITU-T V.24](#) List of definitions for interchange circuits between data terminal equipment (DTE) and data circuit-terminating equipment (DCE)
- [9] [ITU-T V.250](#) Serial asynchronous automatic dialling and control
- [10] [3GPP TS 11.11](#): Specification of the Subscriber Identity Module - Mobile Equipment (SIM - ME) interface
- [11] [3GPP TS 31.101](#): UICC-terminal interface; Physical and logical characteristics
- [12] [3GPP TS 31.102](#): Characteristics of the Universal Subscriber Identity Module (USIM) application
- [13] [ETSI TS 102 221](#): Smart Cards; UICC-Terminal interface; Physical and logical characteristics
- [14] [3GPP TS 11.14](#): Specification of the SIM Application Toolkit for the Subscriber Identity Module - Mobile Equipment (SIM - ME) interface
- [15] [3GPP TS 31.111](#): Universal Subscriber Identity Module (USIM) Application Toolkit (USAT)
- [16] [ETSI TS 102 223](#): Smart Cards; Card Application Toolkit (CAT)
- [17] [3GPP TS 22.002](#) (descendant of 3GPP TS 22.02): Circuit Bearer Services (BS) supported by a Public Land Mobile Network (PLMN)
- [18] [3GPP TS 22.004](#) (descendant of 3GPP TS 02.04): General on supplementary services
- [19] [3GPP TS 22.030](#) (descendant of 3GPP TS 02.30): Man-Machine Interface (MMI) of the Mobile Station (MS)
- [20] [3GPP TS 22.060](#) (descendant of 3GPP TS 02.60): General Packet Radio Service (GPRS); Service description; Stage 1
- [21] [3GPP TS 23.060](#) (descendant of 3GPP TS 03.60): General Packet Radio Service (GPRS); Service description; Stage 2
- [22] [3GPP TS 22.081](#) (descendant of 3GPP TS 02.81): Line Identification Supplementary Services; Stage 1
- [23] [3GPP TS 22.082](#) (descendant of 3GPP TS 02.82): Call Forwarding (CF) Supplementary Services; Stage 1
- [24] [3GPP TS 22.083](#) (descendant of 3GPP TS 02.83): Call Waiting (CW) and Call Holding (HOLD); Supplementary Services; Stage 1
- [25] [3GPP TS 22.085](#) (descendant of 3GPP TS 02.85): Closed User Group (CUG) supplementary services; Stage 1
- [26] [3GPP TS 22.088](#) (descendant of 3GPP TS 02.88): Call Barring (CB) supplementary services; Stage 1
- [27] [3GPP TS 22.090](#) (descendant of 3GPP TS 02.90): Unstructured Supplementary Service Data (USSD); Stage 1
- [28] [3GPP TS 23.038](#) (descendant of 3GPP TS 03.38): Alphabets and language specific information
- [29] [3GPP TS 23.040](#) (descendant of 3GPP TS 03.40): Technical realization of the Short Message Service (SMS)
- [30] [3GPP TS 23.041](#) (descendant of 3GPP TS 03.41): Technical realization of Cell Broadcast Service (CBS)
- [31] [3GPP TS 23.107](#): Quality of Service (QoS) concept and architecture
- [32] [3GPP TS 24.011](#) (descendant of 3GPP TS 04.11): Point-to-Point (PP) Short Message Service (SMS) support on mobile radio interface
- [33] [3GPP TS 24.008](#) (descendant of 3GPP TS 04.08): Mobile radio interface Layer 3 specification; Core network protocols; Stage 3

1.2 Related documents

- [34] [3GPP TS 24.080](#) (descendant of 3GPP TS 04.80): Mobile radio interface layer 3 supplementary services specification; Formats and coding
- [35] [3GPP TS 24.301](#) Non-Access-Stratum (NAS) protocol for Evolved Packet System (EPS)
- [36] [3GPP TS 25.331](#) Radio Resource Control (RRC)
- [37] [3GPP TS 25.133](#) Requirements for support of radio resource management
- [38] [3GPP TS 27.005](#) (descendant of 3GPP TS 07.05): Use of Data Terminal Equipment - Data Circuit terminating Equipment (DTE - DCE) interface for Short Message Service (SMS) and Cell Broadcast Service (CBS)
- [39] [3GPP TS 27.007](#) (descendant of 3GPP TS 07.07): AT command set for User Equipment (UE)
- [40] [3GPP TS 27.060](#) (descendant of 3GPP TS 07.60): Mobile Station (MS) supporting Packet Switched Services
- [41] [3GPP TS 36.133](#) Evolved Universal Terrestrial Radio Access (E-UTRA); Requirements for support of radio resource management
- [42] [3GPP TS 45.008](#) (descendant of GSM 05.08): Radio subsystem link control
- [43] [Documents posted on website of USB Implementers Forum](#)
- [44] [USB Language Identifiers \(LANGIDs\) \[.PDF!\]](#)

1.3 Document Conventions

Throughout this document ELS31-V is also referred to as LTE Engine or short UE, MS (Mobile Station) or Mobile Terminal (MT). In related documents the equivalent term DCE (Data Communication Equipment) may be found. AT commands are used to control the ELS31-V. The controlling device is referred to as Customer Application or short TE. Related documents may use the equivalent term DTE (Data Terminal Equipment). All abbreviations and acronyms used throughout this document are based on 3GPP specifications. For definitions please refer to 3GPP TR 21.905 [5].

1.3.1 Quick Reference Table

Each AT command description includes a table similar to the example shown below. The table is intended as a quick reference to indicate the following functions:

- PIN: Is the AT command PIN protected?
+ Yes
- No
± Usage is dependent on conditions specified for the command, or not all command types are PIN protected (for example write command PIN protected, read command not).
Note: The table provided in Section 18.1, [Available AT Commands and Dependency on SIM PIN](#) uses the same symbols.
- Is the AT command supported in AIRPLANE mode?
+ Yes
- No
± In AIRPLANE mode, not all described functions are available. For example, the test or read command is usable, the write or execute command is not. Furthermore, only some of the listed parameters can be changed in AIRPLANE mode. A typical example is `AT^SCFG` that controls different features.
- Last: If commands are concatenated, this AT command must be the last one.
+ Yes
- No
Note: See also Section 1.4, [AT Command Syntax](#) for details on concatenated AT commands.

Example:

PIN	→	Last
-	-	-

1.3.2 Superscript notation for parameters and values

Table 1.1: Symbols used to mark the type of parameters

Parameter type	Meaning
<param> ^(num)	Parameter value must be numeric type.
<param> ^(str)	Parameter value must be string type.
<param> ^(text)	Parameter value is a string according to selected character set. Not enclosed in double quotes
<param> ^(u)	Unspecified, i.e. parameter value may be numeric or string type.

Table 1.2: Symbols used to indicate storage options or correlations with other commands

Parameter option	Meaning
<param> ^(+CSCS)	Parameter value has to be (is) coded according to current setting of <chset> (see AT+CSCS for details)
<param> ^(&W)	Parameter value is stored to user profile in non-volatile memory after executing AT&W
<param> ^(&V)	Parameter value is displayed by AT&V
<param> ^(NV)	Parameter is stored in non-volatile memory.

Table 1.3: Symbols used to mark different types of default values of parameters

Value option	Meaning
[x]	Default value set if parameter is omitted.
x ^(&F)	Factory value restored by AT&F
x ^(P)	Powerup value of a parameter not stored in non-volatile memory.
x ^(D)	Delivery value of a parameter which may be overridden from non-volatile setting (refer to symbol ^(NV) and symbol ^(&W) above).

1.4 AT Command Syntax

The "AT" or "at" prefix must be set at the beginning of each command line. To terminate a command line enter <CR>. Commands are usually followed by a response that includes "<CR><LF><response><CR><LF>". Throughout this document, only the responses are presented, <CR><LF> are omitted intentionally.

Table 1.4: Types of AT commands and responses

AT command type	Syntax	Function
Test command	AT+CXXX=?	The mobile equipment returns the list of parameters and value ranges set with the corresponding Write command or by internal processes.
Read command	AT+CXXX?	This command returns the currently set value of the parameter or parameters.
Write command	AT+CXXX=<...>	This command sets user-definable parameter values.
Exec(ution) command	AT+CXXX	The execution command reads non-variable parameters determined by internal processes in the UE.

1.4.1 Using Parameters

- Multiple parameters are separated by commas. This applies to write commands, command responses, URCs and result codes. Please note that throughout this document spaces behind commas may be added for better readability.
- Optional parameters are enclosed in square brackets. If optional parameters are omitted, the current settings are used until you change them.
- Optional parameters or subparameters can be omitted unless they are followed by other parameters. If you want to omit a parameter in the middle of a string it must be replaced by a comma.
- A parameter value enclosed in square brackets represents the value that will be used if an optional parameter is omitted. See also example 2.
- When the parameter is a character string the string must be enclosed in quotation marks. Symbols in quotation marks will be recognized as strings.
- All spaces will be ignored when using strings without quotation marks.
- It is possible to omit the leading zeros of strings which represent numbers.
- If an optional parameter of a ITU-T V.250 command is omitted, its value is assumed to be 0.

1.4.2 Concatenating AT Commands

Concatenating AT commands on the same line is possible, though not recommended because of restrictions listed below (for more details see ITU-T V.250 [9]).

When concatenating AT commands you need to enter the "AT" or "at" prefix only once at the beginning of a command line. Basic commands (i.e., ITU-T V.250 commands) are concatenated without delimiter. Extended commands (i.e., commands starting with AT+ or AT^) use a semicolon as delimiter.

Disadvantages and restrictions:

- There is no way to control the minimum time to wait between finishing an AT command and sending the next one. Please refer to Section 1.5, [Communication between Customer Application and ELS31-V](#) for details about timing.
- The sequence of processing the AT commands may be different from the sequential order of command input.
- Many AT commands cannot be concatenated (see list below). Concatenating these commands might end up with an error result code, or leads to an unexpected order of responses.

AT command type	Comment
3GPP TS 27.007 commands	Cannot be concatenated with extended commands (prefix AT^S)
3GPP TS 27.005 commands (SMS)	To be used standalone
Commands starting with AT&	To be used standalone
AT+IPR	To be used standalone

1.5 Communication between Customer Application and ELS31-V

After power-up or restart ensure that the UE is in ready state before trying to send any AT command or data. For detailed information on timing conditions, signal states and particularly the startup behavior of the ELS31-V's signal lines refer to the Hardware Interface Description [2].

Leaving hardware flow control unconsidered the Customer Application (TE) is coupled with the ELS31-V (UE) via a receive and a transmit line.

Since both lines are driven by independent devices collisions may (and will) happen. For example, if the TE issues an AT command and the ELS31-V starts sending a URC. This will probably cause the TE to misinterpret the URC being part of the AT command's response. To avoid this conflict the following measures must be taken:

- If an AT command is finished (with "OK" or "ERROR") the TE shall always wait at least 100 ms before sending the next one. This applies to bit rates of 9600 bps or higher (see [AT+IPR](#)). At bit rates below 9600 bps the delay must be longer: 300 ms at 1200 bps, and 500 ms at 300 bps.
The pause between two AT commands gives the ELS31-V the opportunity to the transmission of pending URCs and get necessary service.
- The TE shall communicate with the ELS31-V using activated echo ([ATE1](#)), i.e. the ELS31-V echoes characters received from the TE.
Hence, when the TE receives the echo of the first character "A" of the AT command just sent by itself it has control both over the receive and the transmit paths.

Using Backspace at command line:

- As the standard GSM alphabet does not provide a backspace functionality the ELS31-V is designed to use the character "08" (hex 0x08) as backspace for command line input. This allows the user to easily erase the last character when writing an AT command. On the other hand, this solution requires entering the escape sequence \08 for writing the "ò" character in GSM character string parameters.
- If command echo is enabled ([ATE1](#)) Backspace may cause 08 - 32 - 08 (decimal) character sequence or no echo, depending on serial interface and speed of character input.

1.6 Supported character sets

1.6 Supported character sets

ELS31-V supports two character sets: *GSM 7 bit*, also referred to as GSM alphabet or SMS alphabet (3GPP TS 23.038 [28]) and *UCS2 16 bit* (ISO-10646 [6]). See [AT+CSCS](#) for information about selecting the character set. Character tables can be found below.

Explanation of terms

• Escape Character

There are two types of escape sequences which lead to an alternative interpretation on subsequent characters by the UE:

- AT command interface

Escape sequences starting with character value 0x5C are used for the UE's non-UCS2 input and output.

- GSM 7 bit default alphabet

The escape sequence used within a text coded in the GSM 7 bit default alphabet is starting with character value 0x1B and needs to be correctly interpreted by the TE, both for character input and output. To the ELS31-V, an escape sequence appears like any other byte received or sent.

For SMS user data input after the prompt '>' in text mode ([AT+CMGF](#))=1 and [AT+CSCS](#)="GSM" the character 0x1A is interpreted as 'CTRL-Z'. The character 0x1B (interpreted as 'ESC') as well as the escape character 0x5C (is interpreted as 'Ö'), therefore both escape mechanisms are not supported in this case.

• TE Character Set

The character set currently used by the Customer Application is selected with [AT+CSCS](#). It is recommended to select UCS2 setting.

• Data Coding Scheme (DCS)

DCS is part of a short message and is saved on the SIM. When writing a short message to the SIM in text mode, the DCS stored with [AT+CSMP](#) is used and determines the coded character set.

• International Reference Alphabet (IRA)

The International Reference Alphabet is equivalent to ASCII (American Standard Code for Information Interchange) and ISO 646, i.e. it defines a 7-bit coded character set. The mapping can be obtained from the character set tables below (UCS2 values 0x0000 to 0x007F).

When you enter characters that are not valid characters of the supported alphabets the behavior is undefined. If GSM alphabet is selected, all characters sent over the serial line (between TE and UE) must be in the range from 0 to 127 (7 bit range).

Note: If the UE is configured for GSM alphabet, but the Customer Application (TE) uses ASCII, bear in mind that some characters have different code values, such as the following:

- "@" character with GSM alphabet value 0 is not displayable by an ASCII terminal program, e.g. Microsoft® Hyperterminal®.
- "@" character with GSM alphabet value 0 will terminate any C string! This is because value 0 is defined as C string end tag. Therefore, the GSM Null character will cause problems on application level when using 'C'-functions, e.g. "strlen()". Using an escape sequence as shown in the table below solves the problem. By the way, this may be the reason why even network providers sometimes replace '@' with "@=" in their SIM application.
- Some other characters of the GSM alphabet may be misinterpreted by an ASCII terminal program. For example, GSM "ö" (as in "Börse") is assumed to be "l" in ASCII, thus resulting in "B|rse". This is because in both alphabets there are different characters assigned to value 7C (hexadecimal).

If the TE sends characters differently coded or undefined in ASCII or GSM (e.g. Ä, Ö, Ü) it is possible to use escape sequences. The UE's input parser translates the escape sequence to the corresponding GSM character value.

Note:

The UE also uses escape sequences for its non-UCS2 output: Quotation mark (") and the escape character itself (\, respectively Ö in GSM alphabet) are converted, as well as all characters with a value below 32 (hexadecimal 0x20).

Hence, the input parser of the Customer Application needs to be able to translate escape sequences back to the corresponding character of the currently used alphabet.

Unsupported characters are shown as a space (hexadecimal 0x20).

1.6 Supported character sets

Table 1.5: Exemplary escape sequences generated by ELS31-V for its non-UCS2 output

Character Value	ASCII Character	GSM Character	UCS2 Character	Escape Sequence	Numeric Escape Sequence
0x5C	\	Ö	00D6	\5C	0x5C 0x35 0x43
0x22	"	"	0022	\22	0x5C 0x32 0x32
0x00	NULL	@	n/a	\00	0x5C 0x30 0x30

Usually terminal programs are not able to recognize escape sequences, and thus, handle them as normal characters.

To prevent misinterpretation of control characters or special characters it is recommended to always use UCS2 alphabet and PDU mode.

1.6 Supported character sets

1.6.1 GSM alphabet tables and UCS2 character values

This section provides tables for the GSM default alphabet (3GPP TS 23.038 [28]) supported by the ELS31-V. Below any GSM character find the corresponding two byte character value of the UCS2 alphabet. For details refer to "ETSI GSM 03.38 mapping into Unicode" [7].

Main character table of GSM 7 bit default alphabet				b7	0	0	0	0	1	1	1	1
				b6	0	0	1	1	0	0	1	1
				b5	0	1	0	1	0	1	0	1
b4	b3	b2	b1		0	1	2	3	4	5	6	7
0	0	0	0	0	@ 0040	Δ 0394	SP 0020	0 0030	i 00A1	P 0050	¿ 00BF	p 0070
0	0	0	1	1	£ 00A3	_ 005F	! 0021	1 0031	A 0041	Q 0051	a 0061	q 0071
0	0	1	0	2	\$ 0024	Φ 03A6	" 0022	2 0032	B 0042	R 0052	b 0062	r 0072
0	0	1	1		3	¥ 00A5	Γ 0393	# 0023	3 0033	C 0043	S 0053	c 0063
0	1	0	0	4	è 00E8	Λ 039B	* 00A4	4 0034	D 0044	T 0054	d 0064	t 0074
0	1	0	1		5	é 00E9	Ω 03A9	% 0025	5 0035	E 0045	U 0055	e 0065
0	1	1	0	6	ù 00F9	Π 03A0	& 0026	6 0036	F 0046	V 0056	f 0066	v 0076
0	1	1	1		7	ì 00EC	Ψ 03A8	' 0027	7 0037	G 0047	W 0057	g 0067
1	0	0	0	8	ò 00F2 ³⁾	Σ 03A3	(0028	8 0038	H 0048	X 0058	h 0068	x 0078
1	0	0	1	9	ç 00E7	Θ 0398) 0029	9 0039	I 0049	Y 0059	i 0069	y 0079
1	0	1	0	10/A	LF [LF] ²⁾	Ξ 039E	* 002A	: 003A	J 004A	Z 005A	j 006A	z 007A
1	0	1	1	11/B	∅ 00D8	¹⁾	+ 002B	; 003B	K 004B	Ä 00C4	k 006B	ä 00E4
1	1	0	0	12/C	ø 00F8	Æ 00C6	, 002C	< 003C	L 004C	Ö 00D6	l 006C	ö 00F6
1	1	0	1	13/D	CR [CR] ²⁾	æ 00E6	- 002D	= 003D	M 004D	Ñ 00D1	m 006D	ñ 00F1
1	1	1	0	14/E	Ä 00C5	ß 00DF	. 002E	> 003E	N 004E	Ü 00DC	n 006E	ü 00FC
1	1	1	1	15/F	ä 00E5	É 00C9	/ 002F	? 003F	O 004F	Ş 00A7	o 006F	à 00E0

Figure 1.1: Main character table of GSM 7 bit default alphabet

- 1) This code is an escape to the following extension of the 7 bit default alphabet table.
- 2) This code is not a printable character and therefore not defined for the UCS2 alphabet. It shall be treated as the accompanying control character.
- 3) See Section 1.5 for further details on using backspace and "ò" character.

Extension character table of GSM 7 bit default alphabet				b7	0	0	0	0	1	1	1	1
				b6	0	0	1	1	0	0	1	1
				b5	0	1	0	1	0	1	0	1
b4	b3	b2	b1		0	1	2	3	4	5	6	7
0	0	0	0	0								
									007C			
0	0	0	1	1								
0	0	1	0	2								
0	0	1	1	3								
0	1	0	0	4		^						
						005E						
0	1	0	1	5						€ ²⁾		
										20AC		
0	1	1	0	6								
0	1	1	1	7								
1	0	0	0	8			{					
							007B					
1	0	0	1	9			}					
							007D					
1	0	1	0	10 /A	³⁾	[LF]						
1	0	1	1	11 /B								
1	1	0	0	12 /C				[
								005B				
1	1	0	1	13 /D				~				
								007E				
1	1	1	0	14 /E]				
								005D				
1	1	1	1	15 /F			\					
							005C					

Figure 1.2: Extension character table of GSM 7 bit default alphabet

- 1) This code value is reserved for the extension to another extension table. On receipt of this code, a receiving entity shall display a space until another extension table is defined.
- 2) This code represents the EURO currency symbol. The code value is the one used for the character 'e'. Therefore a receiving entity which is incapable of displaying the EURO currency symbol will display the character 'e' instead.
- 3) This code is defined as a Page Break character and may be used for example in compressed CBS messages. Any mobile which does not understand the 7 bit default alphabet table extension mechanism will treat this character as Line Feed.

1.6 Supported character sets

If the Customer Application receives a code where a symbol is not represented in Figure 1.2, [Extension character table of GSM 7 bit default alphabet](#) it shall display the character shown in the main GSM 7 bit default alphabet table (see Figure 1.1, [Main character table of GSM 7 bit default alphabet](#)).

1.6.2 UCS2 and GSM character coding and conversion

This section provides basic information on how to handle input and output character conversion, e.g. for SMS text mode, if the character representation of UE and Customer Application differ, i.e. if the Data Coding Scheme and the TE character set use different mappings.

1.6.2.1 Output of SIM data (UE to TE)

Used character set	DCS = 7 bit GSM	DCS = 8 bit Data	DCS = 16 bit UCS2
GSM	Case 1 GSM (1:1)	Case 2 8 bit to IRA (1:2)	Case 3 UCS2 to IRA (2:4)
UCS2	Case 4 GSM to IRA (1:4)	Case 5 8 bit to IRA (1:4)	Case 6 UCS2 to IRA (2:4)

Note: The ratio of SIM bytes to output bytes is given in parentheses.

Case 1

Every GSM character is sent to the TE as it is (8-bit value with highest bit set to zero).

Example: 47'H, 53'H, 4D'H → 47'H, 53'H, 4D'H, displayed as "GSM"

Case 2

Every data byte is sent to the TE as 2 IRA characters each representing a halfbyte.

Example: B8'H (184 decimal) → 42'H, 38'H, displayed as "B8"

Case 3

Every 16-bit UCS2 value is sent to the TE as 4 IRA characters.

Example: C4xA7'H (50343 decimal) → 43'H, 34'H, 41'H, 37'H, displayed as "C4A7"

Problem: An odd number of bytes leads to an error because there are always two bytes needed for each UCS2 character

Case 4

Every GSM character is sent to the TE as 4 IRA characters to show UCS2 in text mode.

Example: 41'H ("A") → 30'H, 30'H, 34'H, 31'H, displayed as "0041"

Case 5

Every data byte is sent to the TE as IRA representation of UCS2 (similar to case 4).

Example: B2'H → 30'H, 30'H, 42'H, 32'H, displayed as "00B2"

Case 6

Every 16-bit value is sent to the TE as IRA representation of it. It is assumed that number of bytes is even.

Example: C3x46'H → 43'H, 33'H, 34'H, 36'H, displayed as "C346"

1.6 Supported character sets

1.6.2.2 Input of SIM data (TE to UE)

Used character set	DCS = 7 bit GSM	DCS = 8 bit Data	DCS = 16 bit UCS2
GSM	Case 1 GSM (1:1)	Case 2 IRA to 8 bit (2:1)	Case 3 IRA to 16 bit (4:2)
UCS2	Case 4 UCS2 to GSM (4:1)	Case 5 UCS2 to 8 bit (4:1)	Case 6 UCS2 to 16 bit (4:2)

Note: The ratio between the number of input characters and bytes stored on the SIM is given in parentheses.

Case 1

Every character is sent from TE to UE as GSM character (or ASCII with standard terminal emulation, e.g. Hyperterminal®).

Character value must be in range from 0 to 127 because of 7-bit GSM alphabet.

To reach maximum SMS text length of 160 characters in 140 bytes space characters will be compressed on SIM. This must be set using the parameter `<dcsc>` of `AT+CSMP` (add 64).

Example: "ABCDEFGH" typed is sent and stored uncompressed as → 4142434445464748'H (stored compressed as 41E19058341E91'H)

Case 2

Every data byte is sent as 2 IRA characters.

Maximum text length is 280 IRA characters which will be converted into 140 bytes SMS binary user data

Example: "C8" typed is sent as 43'H, 38'H → stored as C8'H

Case 3

Every 16-bit value is sent as 4 IRA characters.

Maximum text length is 280 IRA characters which will be converted into 70 UCS2 characters (16-bit each)

Number of IRA characters must be a multiple of four because always 4 half bytes are needed for a 16-bit value

Example: "D2C8" typed is sent as 44'H, 32'H, 43'H, 38'H → stored as D2C8'H

Case 4

Every GSM character is sent as 4 IRA characters representing one UCS2 character.

Example: To store text "ABC" using UCS2 character set you have to type "004100420043".

This is sent as 30'H,30'H,34'H,31'H, 30'H,30'H,34'H,32'H, 30'H,30'H,34'H,33'H → detected as IRA representation of 3 UCS2 characters, converted to GSM character set and stored as 41'H, 42'H, 43'H.

Maximum input is 640 IRA characters representing 160 UCS2 characters when compression is active. These are converted to 160 GSM 7-bit characters.

Without compression only 140 GSM characters can be stored which are put in as 560 IRA characters.

Values of UCS2 characters must be smaller than 80'H (128 decimal) to be valid GSM characters.

Number of IRA characters must be a multiple of four. Problems:

- "41" → Error, there are four IRA characters (two bytes) needed
- "0000" → Error, not an UCS2 character
- "4142" → Error, value of UCS2 character > 7F'H
- "008B" → Error, value of UCS2 character > 7F'H

This affects the maximum input length of a string)

Case 5

Every UCS2 character is sent as 4 IRA characters and is converted into two 8-bit values. This means that the first two characters have to be '00'.

Example: UCS2 character 009F'H typed as "009F" is sent as 30'H,30'H,39'H,46'H → converted into 8-bit value 9F'H.

Maximum number of UCS2 characters is 140 which are represented by 560 IRA characters. Number of IRA characters must be a multiple of four.

Case 6

Every UCS2 character is sent as 4 IRA characters each and is converted into a 16-bit value again.

Example: UCS2 character 9F3A'H typed as "9F3A" is sent as 39'H,46'H,33'H,41'H → converted into 9F3A'H.

Maximum number of UCS2 characters is 70 which are represented by 280 IRA characters. Number of IRA characters must be a multiple of four.

Invalid UCS2 values must be prevented.

1.7 Unsolicited Result Code Presentation

URC stands for Unsolicited Result Code and is a report message issued by the UE without being requested by the TE, i.e. an URC is issued automatically when a certain event occurs. Hence, a URC is not issued as part of the response related to an executed AT command.

Typical events leading to URCs are received short messages, changes in temperature, network registration etc. For most of these messages, the UE needs to be configured whether or not to send a URC. Descriptions of these URCs are provided with the associated AT command. A summary of all URCs can be found in Section 18.5, [Summary of Unsolicited Result Codes \(URC\)](#).

Important: If the interface used for URC output is reserved by an active data connection or a long running AT command, URCs are buffered internally and will be issued after the interface becomes idle again. A pending URC will be signaled on the URC output interface via RING line. This allows to systematically suspend any longer data connection (refer [+++](#) and [ATO](#)) to check for pending URCs after being signaled!

For detailed information regarding configuration of URC signaling refer to [AT^SCFG](#), "URC/Ringline", [<urcRinglineCfg>](#).

1.7.1 Common URCs

This section contains all URCs not associated to a certain AT command. They cannot be defined by the user and appear automatically when the voltage conditions described below occur.

Notes for "^SBC" URCs reporting undervoltage/overvoltage conditions:

Please refer to [\[2\]](#) for specifications regarding the minimum and maximum operating voltage limits. If the supply voltage exceeds the defined thresholds the UE switches off automatically. The automatic shutdown procedure is equivalent to the power-down initiated with the [AT^SMSO](#) command.

URC 1

`^SYSSTART`

Indicates that the UE has been restarted to Normal mode or Airplane mode and is ready to operate. For Normal and Airplane mode see [AT+CFUN](#).

URC 2

`^SBC: Undervoltage Warning`

Supply voltage is close to the defined undervoltage threshold.

URC 3

`^SBC: Undervoltage Shutdown`

Undervoltage threshold exceeded. UE automatically switches off.

URC 4

`^SBC: Overvoltage Warning`

Supply voltage is close to defined overvoltage threshold.

URC 5

`^SBC: Overvoltage Shutdown`

Overvoltage threshold exceeded. UE automatically switches off.

1.8 Errors and Messages

The command result codes "+CME ERROR: <err>" and "+CMS ERROR: <err>" indicate errors related to mobile equipment or network functionality.

The format of <err> can be either numeric or verbose and is selectable via [AT+CMEE](#).

A result error code terminates the execution of the command and prevents the execution of all remaining commands that may follow on the same command line. If so, neither "ERROR" nor "OK" result codes are returned for these commands. A 30 seconds timeout will deliver "ERROR" when the input of a command is not complete.

Using the wrong command syntax may result in errors: For example, using the execute command syntax although the command has no execute format, causes "ERROR" to be returned. Likewise, using the write command syntax although the command has no write format causes "+CME ERROR: <err>" to be returned.

See also:

- Section [2.9.1](#), [CME/CMS Error Code Overview](#)
- Section [2.5.1](#), [Verbose and numeric result codes](#)
- Section [3.1](#), [AT+CEER](#)

2. Configuration Commands

The AT Commands described in this chapter allow the external application to determine the ELS31-V's behaviour under various conditions.

2.1 AT&F Reset AT Command Settings to Factory Default Values

[AT&F](#) resets AT command settings to their factory default values.

For a list of affected parameters refer to Section [18.4, Factory Default Settings Restorable with AT&F](#).

Syntax

Exec Command	
AT&F[<value>]	
Response(s)	
OK	
PIN → Last	Reference(s)
- + -	V.250

Parameter Description

<value> ^(num)	
[0]	Reset parameters in Section 18.4, Factory Default Settings Restorable with AT&F to their factory default values.

2.2 AT&V Display current configuration

[AT&V](#) returns the current parameter setting. The configuration varies depending on whether or not PIN authentication has been done.

Syntax

Exec Command	
AT&V[<value>]	
Response(s)	
ACTIVE PROFILE: ... (see Section 2.2.1, AT&V responses) OK	
PIN → Last	Reference(s)
- + -	V.250

Parameter Description

<value> ^(num)	
[0]	Profile number

Note

- The parameter of [AT+CSDH](#) will only be displayed in SMS Text mode, see [AT+CMGF](#).

2.2.1 AT&V responses

The following table shows different kinds of responses depending on whether or not the PIN is entered.

PIN authentication done	No PIN authentication
ACTIVE PROFILE: E1 Q0 V1 &C1 &D2 &S0 \Q3 S0:000 S3:013 S4:010 S5:008 S6:000 S7:060 S8:000 S10:002 +CMGF: 1 +CSDH: 0 +CNMI: 0,0,0,0,1 +ICF: 3 +IPR: 115200 +CMEE: 2 +CSMS: 0,1,1,1 +CEREG: 0,1 +COPS: 0,0,"operator" +CGSMS: 0 OK	ACTIVE PROFILE: E1 Q0 V1 &C1 &D2 &S0 \Q3 S0:000 S3:013 S4:010 S5:008 S6:000 S7:060 S8:000 S10:002 +ICF: 3 +IPR: 115200 OK

2.3 AT&W Store AT Command Settings to User Defined Profile

[AT&W](#) stores the current AT command settings to a user defined profile in non-volatile memory of ELS31-V. The AT command settings will automatically be restored from the user defined profile during power-up or if [ATZ](#) is used. [AT&F](#) restores AT command factory default settings. Hence, until first use of [AT&W](#), [ATZ](#) works as [AT&F](#). A list of parameters stored to the user profile can be found at Section [18.3, AT Command Settings storable with AT&W](#).

Syntax

Exec Command	
AT&W[<value>]	
Response(s)	
OK	
ERROR	
+CME ERROR: <err>	
PIN → Last	Reference(s)
- + -	V.250

Parameter Description

<value> ^(num)	
[0]	User Profile Number

2.4 ATQ Result Code Presentation Mode

ATQ controls if the ELS31-V transmits any result code to the TE. Other information text transmitted as response is not affected.

Syntax

Exec Command	
ATQ[<n>]	
Response(s)	
If <n>=0: OK	
If <n>=1: (none)	
PIN → Last	Reference(s)
- + -	V.250

Parameter Description

<n> ^{(num)(&V)(&W)}	
Result Code Presentation Mode. It is not recommended to change this value.	
[0] ^{(&F)(D)}	UE transmits result code.
1	Result codes are suppressed and not transmitted.

2.5 ATV Result code format mode

This command determines the contents of header and trailer transmitted with AT command result codes and information responses. Possible responses are described in Section 2.5.1, [Verbose and numeric result codes](#).

Syntax

Exec Command	
ATV[<value>]	
Response(s)	
OK ERROR	
PIN → Last	Reference(s)
- + -	ITU-T V.250 [9]

Parameter Description

<value> ^{(num)(&V)(&W)}	
[0]	Information response: <text><CR><LF> Short result code format: <numeric code><CR>
1 ^{(&F)(D)}	Information response: <CR><LF><text><CR><LF> Long result code format: <CR><LF><verbose code><CR><LF>

2.5.1 Verbose and numeric result codes

Verbose format	Numeric format	Meaning
OK	0	command executed, no errors
CONNECT	1	link established
RING	2	ring detected
NO CARRIER	3	link not established or disconnected
ERROR	4	invalid command or command line too long

2.6 ATZ Restore AT Command Settings from User Defined Profile

First [ATZ](#) resets the AT command settings to their factory default values, similar to [AT&F](#). Afterwards the AT command settings are restored from a user defined profile in non-volatile memory of ELS31-V, if one was stored with [AT&W](#) before. Any additional AT command on the same command line may be ignored. A delay of 300 ms is required before next AT command is sent.

Syntax

Exec Command	
ATZ[<value>]	
Response(s)	
OK	
PIN → Last	Reference(s)
- + -	V.250

Parameter Description

<value> ^(num)	
[0]	User Profile Number

2.7 AT+CFUN Functionality Level

AT+CFUN controls ELS31-V's functionality levels. It can also be used to reset the UE.

Syntax

<p>Test Command</p> <p>AT+CFUN=?</p> <p>Response(s)</p> <p>+CFUN: (list of supported <fun>s), (list of supported <rst>s)</p> <p>OK</p> <p>ERROR</p> <p>+CME ERROR: <err></p>	
<p>Read Command</p> <p>AT+CFUN?</p> <p>Response(s)</p> <p>+CFUN: <fun></p> <p>OK</p> <p>ERROR</p> <p>+CME ERROR: <err></p>	
<p>Write Command</p> <p>AT+CFUN=<fun>[, <rst>]</p> <p>Response(s)</p> <p>OK</p> <p>ERROR</p> <p>+CME ERROR: <err></p> <p>If <fun>= 0:</p> <p>OK</p> <p>If <rst>= 1:</p> <p>OK</p> <p>^SHUTDOWN</p> <p>^SYSSTART</p>	
<p>PIN → Last</p> <p>- + -</p>	<p>Reference(s)</p> <p>3GPP TS 27.007 [39]</p>

Parameter Description

<fun> ^(num)	Description
0	<p>Minimum functionality.</p> <p>Shuts down TX and RX RF-circuits whereby ELS31-V logs off from the network. Access to the (U)SIM is also disabled. All AT commands whose execution requires a radio connection or (U)SIM access will return an error result code.</p> <p>To return to normal mode the command AT+CFUN=1 can be used. After this, SIM PIN authentication is necessary for registering to a network.</p>
1 ^(D)	<p>Full functionality level.</p>
4	<p>Airplane mode.</p> <p>Shuts down TX and RX RF-circuits whereby ELS31-V logs off from the network and switches to AT+COPS=2. AT commands whose execution requires a radio connection will return an error response (such as "NO CARRIER" or "+CME ERROR: NO NETWORK SERVICE". A list of AT commands supported during</p>

Airplane mode can be found in Section [18.2, Availability of AT Commands Depending on Operating Mode of ME](#).

The benefit of Airplane mode is that, at locations where no RF emission is allowed (typically airplanes, hospitals etc.), the subscriber can continue using network-independent features rather than powering off the entire device (e.g. a PDA or smartphone).

`<rst>`^(num)

Parameter `<rst>` applies only to `<fun>` 1 and 4.

- | | |
|-----|--|
| [0] | UE switches to <code><fun></code> level without reset. |
| 1 | UE resets and restarts to full functionality level or Airplane mode, depending on given <code><fun></code> value. " <code>^SHUTDOWN</code> " URC indicates that the UE has completed the reset procedure and will restart. " <code>^SYSSTART</code> " URC indicates that the UE has restarted and is ready to operate. |

2.8 AT^SMSO Switch Off ELS31-V

AT^SMSO initiates ELS31-V's power-off procedure. Do not send any other AT command after this.

Low level of the ME's V180 signal and the URC "[^SHUTDOWN](#)" notify that the procedure has completed and the ME has entered the POWER DOWN mode. Therefore, be sure not to disconnect the operating voltage until the V180 signal has gone low and until the URC "[^SHUTDOWN](#)" is displayed. Otherwise, you run the risk of losing data. For further details on how to turn off the ME refer to [\[2\]](#). If a fast switch off (see parameter [<fso>](#) in [AT^SCFG](#)) is enabled, there is no reply like OK, ERROR or any "[^SHUTDOWN](#)" URC.

Syntax

```
Test Command
AT^SMSO=?
Response(s)
OK

Exec Command
AT^SMSO
Response(s)
^SMSO: MS OFF
OK
ERROR

PIN → Last
- + +
```

Unsolicited Result Code

[^SHUTDOWN](#)

Indicates that the power-off procedure is finished and the module will be switched off in less than 1 second. If [<fso>](#) is used to enable a fast UE switch off, there will be no "[^SHUTDOWN](#)" URC.

Note

- If [<fso>](#) is used to enable a fast UE switch off, flash access cycles (writing/deleting) will be finalized, but there will no longer be any network deregistration, the current settings will not be saved and there will be no further output on the interfaces. All other jobs will be deleted and logical data consistence cannot be guaranteed.

2.9 AT+CMEE Error Message Format

AT+CMEE controls the format of error result codes that indicates errors related to ELS31-V functionality. Format can be selected between plain "ERROR" output, error numbers or verbose "+CME ERROR: <err>" and "+CMS ERROR: <err>" messages.

Possible error result codes are listed in Table 2.1, General "CME ERROR" Codes (3GPP TS 27.007), Table 2.2, EPS related "CME ERROR" Codes (3GPP TS 27.007) and Table 2.3, SMS related "CMS ERROR" Codes (3GPP TS 27.005).

Syntax

<p>Test Command</p> <p>AT+CMEE=?</p> <p>Response(s)</p> <p>+CMEE: (list of supported<errMode>s)</p> <p>OK</p>	
<p>Read Command</p> <p>AT+CMEE?</p> <p>Response(s)</p> <p>+CMEE: <errMode></p> <p>OK</p>	
<p>Write Command</p> <p>AT+CMEE=<errMode></p> <p>Response(s)</p> <p>OK</p> <p>ERROR</p> <p>+CME ERROR: <err></p>	
<p>PIN → Last</p> <p>- + -</p>	<p>Reference(s)</p> <p>3GPP TS 27.007 [39], 3GPP TS 27.005 [38]</p>

Parameter Description

<errMode> ^{(num)(&V)(&W)}	
0(&F)(D)	Disable result code, i.e. only "ERROR" will be displayed.
1	Enable error result code with numeric values.
2	Enable error result code with verbose (string) values.

Example

To obtain enhanced error messages it is recommended to choose <errMode>=2.

```
AT+CMEE=2
OK
```

2.9.1 CME/CMS Error Code Overview

Table 2.1: General "CME ERROR" Codes (3GPP TS 27.007)

<err> Code	Text (if AT+CMEE=2)
0	phone failure
1	no connection to phone
2	phone adapter link reserved
3	operation not allowed
4	operation not supported
5	PH-SIM PIN required
6	PH-FSIM PIN required
7	PH-FSIM PUK required
10	SIM not inserted
11	SIM PIN required
12	SIM PUK required
13	SIM failure
14	SIM busy
15	SIM wrong
16	incorrect password
17	SIM PIN2 required
18	SIM PUK2 required
20	memory full
21	invalid index
22	not found
23	memory failure
24	text string too long
25	invalid characters in text string
26	dial string too long
27	invalid characters in dial string
30	no network service
31	network timeout
32	network not allowed - emergency calls only
40	network personalization PIN required
41	network personalization PUK required
42	network subset personalization PIN required
43	network subset personalization PUK required
44	service provider personalization PIN required
45	service provider personalization PUK required
46	corporate personalization PIN required
47	corporate personalization PUK required
50	Incorrect parameters
48	PH-SIM PUK (master phone code) required
100	unknown

<err> Code	Text (if AT+CMEE=2)
256	operation temporary not allowed
257	call barred
258	phone busy
259	user abort
260	invalid dial string
261	SS not executed
262	SIM blocked
263	invalid block

Table 2.2: EPS related "CME ERROR" Codes (3GPP TS 27.007)

<err> Code	Text (if AT+CMEE=2)
103	illegal MS (#3)
106	illegal ME (#6)
107	EPS services not allowed (#)
111	PLMN not allowed (11)
113	roaming not allowed in this tracking area (#13)
132	service option not supported (#32)
133	requested service option not subscribed (#33)
134	service option temporary out of order (34)
151	invalid mobile class (#51)

Table 2.3: SMS related "CMS ERROR" Codes (3GPP TS 27.005)

<err> Code	Text (if AT+CMEE=2)
1	unassigned (unallocated) number
8	operator determined barring
10	call barred
21	short message transfer rejected
27	destination out of service
28	unidentified subscriber
29	facility rejected
30	unknown subscriber
38	network out of order
41	temporary failure
42	congestion
47	resources unavailable, unspecified
50	requested facility not subscribed
69	requested facility not implemented
81	invalid short message transfer reference value
95	invalid message, unspecified
96	invalid mandatory information
97	message type non-existent or not implemented
98	message not compatible with short message protocol state

<err> Code	Text (if AT+CMEE=2)
99	information element non-existent or not implemented
111	protocol error, unspecified
127	interworking, unspecified
128	telematic interworking not supported
129	short message type 0 not supported
130	cannot replace short message
143	unspecified TP-PID error
144	data coding scheme (alphabet) not supported
145	message class not supported
159	unspecified TP-DCS error
160	command cannot be actioned
161	command unsupported
175	unspecified TP-command error
176	TPDU not supported
192	SC busy
193	no SC subscription
194	SC system failure
195	invalid SME address
196	destination SME barred
197	SM rejected-duplicate SM
198	TP-VPF not supported
199	TP-VP not supported
208	do SIM SMS storage full
209	no SMS storage capability in SIM
210	error in MS
211	memory capacity exceeded
212	SIM application toolkit busy
213	SIM data download error
255	unspecified error cause
300	ME failure
301	SMS service of ME reserved
302	operation not allowed
303	operation not supported
304	invalid PDU mode parameter
305	invalid text mode parameter
310	SIM not inserted
311	SIM PIN required
312	PH-SIM PIN required
313	SIM failure
314	SIM busy
315	SIM wrong
316	SIM PUK required

<err> Code	Text (if AT+CMEE=2)
317	SIM PIN2 required
318	SIM PUK2 required
320	memory failure
321	invalid memory index
322	memory full
330	SMSC address unknown
331	no network service
332	network timeout
340	no +CNMA acknowledgement expected
500	unknown error
512	user abort
513	unable to store
514	invalid status
515	invalid character in address string
516	invalid length
517	invalid character in PDU
518	invalid parameter
519	invalid length or character
520	invalid character in text
521	timer expired
522	operation temporary not allowed

2.10 AT+CSCS Character Set

AT+CSCS write command informs the ELS31-V which character set is used by the TE. This enables the UE to convert character strings correctly between TE and UE character sets. Please also refer to Section 1.6, [Supported character sets](#).

Note: If UE-TE interface is set to 8-bit operation ([AT+ICF](#)) and selected character set is `<chset>="GSM"` (7-bit), the highest bit will be set to zero.

Syntax

<p>Test Command</p> <p>AT+CSCS=?</p> <p>Response(s)</p> <p>+CSCS: (list of supported<chset>s)</p> <p>OK</p>	
<p>Read Command</p> <p>AT+CSCS?</p> <p>Response(s)</p> <p>+CSCS: <chset></p> <p>OK</p>	
<p>Write Command</p> <p>AT+CSCS=<chset></p> <p>Response(s)</p> <p>OK</p> <p>ERROR</p> <p>+CME ERROR: <err></p>	
<p>PIN → Last</p> <p>- + -</p>	<p>Reference(s)</p> <p>3GPP TS 27.007 [39]</p>

Parameter Description

<code><chset></code> ^(str)	
"GSM" ^{(&F)(P)}	GSM 7 bit default alphabet (3GPP TS 23.038 [28], Subclause 6.2.1).
"UCS2"	16-bit universal multiple-octet coded character set (ISO-10646 [6]). UCS2 character strings are converted to hexadecimal numbers in the range 0000 to FFFF; e.g. "004100620063" equates to three 16-bit characters with decimal values 65, 98 and 99.

2.11 AT^SCFG Extended Configuration Settings

AT^SCFG can be used to query and configure various settings of the ELS31-V.

AT^SCFG read command returns a list of all supported parameters and their current values.

AT^SCFG write command queries a configuration parameter (if no value is entered) or sets its value(s).

Input of parameter names is always coded in GSM character set, parameter values are expected to be given as specified via AT+CSCS.

Syntax

Test Command

AT^SCFG=?

Response(s)

```

^SCFG: "GPIO/mode/ASC1", (list of supported <g_mode>s)
^SCFG: "GPIO/mode/DCD0", (list of supported <g_mode>s)
^SCFG: "GPIO/mode/DSR0", (list of supported <g_mode>s)
^SCFG: "GPIO/mode/DTR0", (list of supported <g_mode>s)
^SCFG: "GPIO/mode/FSR", (list of supported <g_mode>s)
^SCFG: "GPIO/mode/PULSE", (list of supported <g_mode>s)
^SCFG: "GPIO/mode/RING0", (list of supported <g_mode>s)
^SCFG: "GPIO/mode/SPI", (list of supported <g_mode>s)
^SCFG: "GPIO/mode/SYNC", (list of supported <g_mode>s)
^SCFG: "MEopMode/CFUN", (list of supported <cfun>s), (list of supported <cfun_save>s)
^SCFG: "MEopMode/PingRsp", (list of supported <pingv>s)
^SCFG: "Ident/Manufacturer", (max. string length of <manufacturer>)
^SCFG: "Ident/Product", (max. string length of <product>)
^SCFG: "MEShutdown/Fso", (list of supported <fso>s)
^SCFG: "MEShutdown/sVsup/threshold", (list of supported <vthresh>s), (list of supported
<PowerSupplyDomain>s)
^SCFG: "Radio/Band", (list of supported <rba>s), (list of supported <rbe>s)
^SCFG: "Radio/Mtpl", (list of supported <PL_mode>s), (list of supported <PL_profile>s), (list of supported
<rba>s), (list of supported <PL_limit>s)
^SCFG: "Serial/Interface/Allocation", (list of supported <curSerialIfcAlloc>s), (list of supported
<reqSerialIfcAlloc>s)
^SCFG: "Serial/USB/DDD", (list of supported <deviceDescr>s), (list of supported <descrIndex>s),
(max. string length of <langId>), (max. string length of <vendorId>), (max. string length of
<productId>), (max. string length of <manufacturer>), (max. string length of <product>), (max. string
length of <serialNo>)
^SCFG: "Sim/CCIN", (list of supported <SimPollingMode>s)
^SCFG: "Sim/CCIN/Poll", (list of supported <SimPollingTimer>s)
^SCFG: "Sim/CS", (list of supported <CS>s)
^SCFG: "Tcp/IPv6Priv", (list of supported <v6privacyv>s)
^SCFG: "Tcp/Loop", (list of supported <loopback>s)
^SCFG: "Tcp/MR", (list of supported <tcpMr>)
^SCFG: "Tcp/OT", (list of supported <tcpOt>)
^SCFG: "Tcp/WithURCs", (list of supported <tcpWithUrc>)
^SCFG: "Tcp/TLS/Version", (list of supported <TLS_min_version>s), (list of supported
<TLS_max_version>s)
^SCFG: "Tcp/UnreachRsp", (list of supported <unreachv>s)
^SCFG: "URC/Ringline", (list of supported <urcRinglineCfg>s)
^SCFG: "URC/Ringline/ActiveTime", (list of supported <urcRinglineDuration>s)
OK

```

Read Command

AT^SCFG?

Response(s)

```
^SCFG: "GPIO/mode/ASC1", <g_mode>
^SCFG: "GPIO/mode/DCD0", <g_mode>
^SCFG: "GPIO/mode/DSR0", <g_mode>
^SCFG: "GPIO/mode/DTR0", <g_mode>
^SCFG: "GPIO/mode/FSR", <g_mode>
^SCFG: "GPIO/mode/PULSE", <g_mode>
^SCFG: "GPIO/mode/RING0", <g_mode>
^SCFG: "GPIO/mode/SPI", <g_mode>
^SCFG: "GPIO/mode/SYNC", <g_mode>
^SCFG: "MEopMode/CFUN", <cfun>, <cfun_save>
^SCFG: "MEopMode/PingRsp", <pingv>
^SCFG: "Ident/Manufacturer", <manufacturer>
^SCFG: "Ident/Product", <product>
^SCFG: "MEShutdown/Fso", <fso>
^SCFG: "MEShutdown/sVsup/threshold", <vthresh_BB_curr>, <vthresh_BB_request>
^SCFG: "Radio/Band", <rba>
^SCFG: "Radio/Mtpl", <PL_mode>[, <PL_profile>]
^SCFG: "Serial/Interface/Allocation", <curSerialIfcAlloc>, <reqSerialIfcAlloc>
^SCFG: "Serial/USB/DDD", <deviceDescr>, <descrIndex>, <langId>, <vendorId>, <productId>,
<manufacturer>, <product>, <serialNo>
^SCFG: "Sim/CCIN", <SimPollingMode>
^SCFG: "Sim/CCIN/Poll", <SimPollingTimer>
^SCFG: "Sim/CS", <CS>
^SCFG: "Tcp/IPv6Priv", <v6privacyv>
^SCFG: "Tcp/Loop", <loopback>
^SCFG: "Tcp/MR", <tcpMr>
^SCFG: "Tcp/OT", <tcpOt>
^SCFG: "Tcp/UnreachRsp", <unreachv>
^SCFG: "Tcp/TLS/Version", <TLS_min_version>, <TLS_max_version>
^SCFG: "Tcp/WithURCs", <tcpWithUrc>
^SCFG: "URC/Ringline", <urcRinglineCfg>
^SCFG: "URC/Ringline/ActiveTime", <urcRinglineDuration>
OK
```

Write Command

Configure ASC1 interface lines RXD1, TXD1, RTS1, CTS1 shared with GPIO16 - GPIO19 lines

AT^SCFG="GPIO/mode/ASC1"[, <g_mode>]

Response(s)

```
^SCFG: "GPIO/mode/ASC1", <g_mode>
OK
ERROR
+CME ERROR: <err>
```

Write Command

Configure DCD0 line of ASC0 interface shared with GPIO2

AT^SCFG="GPIO/mode/DCD0"[, <g_mode>]

Response(s)

```
^SCFG: "GPIO/mode/DCD0", <g_mode>
OK
ERROR
+CME ERROR: <err>
```

Write Command

Configure DSR0 line of ASC0 interface shared with GPIO3 line

```
AT^SCFG="GPIO/mode/DSR0"[, <g_mode>]
```

Response(s)

```
^SCFG: "GPIO/mode/DSR0", <g_mode>  
OK  
ERROR  
+CME ERROR: <err>
```

Write Command

Configure DTR0 line of ASC0 interface shared with GPIO1 line

```
AT^SCFG="GPIO/mode/DTR0"[, <g_mode>]
```

Response(s)

```
^SCFG: "GPIO/mode/DTR0", <g_mode>  
OK  
ERROR  
+CME ERROR: <err>
```

Write Command

Configure Fast Shutdown line FST_SHDN shared with GPIO4 line

```
AT^SCFG="GPIO/mode/FSR"[, <g_mode>]
```

Response(s)

```
^SCFG: "GPIO/mode/FSR", <g_mode>  
OK  
ERROR  
+CME ERROR: <err>
```

Write Command

Configure Impulse Counter line (COUNTER) shared with GPIO8 line

```
AT^SCFG="GPIO/mode/PULSE"[, <g_mode>]
```

Response(s)

```
^SCFG: "GPIO/mode/PULSE", <g_mode>  
OK  
ERROR  
+CME ERROR: <err>
```

Write Command

Configure RING0 line of ASC0 interface shared with GPIO24 line

```
AT^SCFG="GPIO/mode/RING0"[, <g_mode>]
```

Response(s)

```
^SCFG: "GPIO/mode/RING0", <g_mode>  
OK  
ERROR  
+CME ERROR: <err>
```

Write Command

Configure SPI lines SPI_CS1 and SPI_CS2 shared with GPIO26 and GPIO27 lines

```
AT^SCFG="GPIO/mode/SPI"[, <g_mode>]
```

Response(s)

```
^SCFG: "GPIO/mode/SPI", <g_mode>  
OK  
ERROR  
+CME ERROR: <err>
```

Write Command

Configure Status LED line shared with GPO5 line

```
AT^SCFG="GPIO/mode/SYNC"[, <g_mode>]
```

Response(s)

```
^SCFG: "GPIO/mode/SYNC", <g_mode>
```

OK

ERROR

+CME ERROR: <err>

Write Command

Enable/disable non volatile storage of AT+CFUN.

```
AT^SCFG="MEopMode/CFUN"[, <cfun>]
```

Response(s)

```
^SCFG: "MEopMode/CFUN", <cfun>, <cfun_save>
```

OK

ERROR

+CME ERROR: <err>

Write Command

Allow/block response on PING

```
AT^SCFG="MEopMode/PingRsp"[, <pingv>]
```

Response(s)

```
^SCFG: "MEopMode/PingResp", <pingv>
```

OK

ERROR

+CME ERROR: <err>

Write Command

Configure manufacturer name.

```
AT^SCFG="Ident/Manufacturer"[, <manufacturer>]
```

Response(s)

```
^SCFG: "Ident/Manufacturer", <manufacturer>
```

OK

ERROR

+CME ERROR: <err>

Write Command

Configure product name.

```
AT^SCFG="Ident/Product"[, <product>]
```

Response(s)

```
^SCFG: "Ident/Product", <product>
```

OK

ERROR

+CME ERROR: <err>

Write Command

Enable/disable fast switch off.

```
AT^SCFG="MEShutdown/Fso"[, <fso>]
```

Response(s)

```
^SCFG: "MEShutdown/Fso", <fso>
```

OK

ERROR

+CME ERROR: <err>

Write Command

Query / configure undervoltage threshold

```
AT^SCFG="MESHUTDOWN/sVsup/threshold"[, <vthresh>][, <PowerSupplyDomain>]
```

Response(s)

```
^SCFG: "MESHUTDOWN/sVsup/threshold", <vthresh_BB_curr>, <vthresh_BB_request>  
OK  
ERROR  
+CME ERROR: <err>
```

Write Command

Enable/disable radio bands.

```
AT^SCFG="Radio/Band"[, <rba>][, <rbe>]
```

Response(s)

```
^SCFG: "Radio/Band", <rba>  
OK  
ERROR  
+CME ERROR: <err>
```

Write Command

Instant Power Limitation for SAR Reduction and Thermal Mitigation

```
AT^SCFG="Radio/Mtpl"[, <PL_mode>][, <PL_profile>, <rba>, <PL_limit>]
```

Response(s)

```
^SCFG: "Radio/Mtpl", <PL_mode>[, <PL_profile>, <rba>, <PL_limit>]
```

In case of: <PL_mode>=0

```
^SCFG: "Radio/Mtpl", <PL_mode>
```

In case of: <PL_mode>=1 and <PL_profile>

```
^SCFG: "Radio/Mtpl", <PL_mode>, <PL_profile>
```

In case of: <PL_mode>=2 and <PL_profile> one profile configuration is printed out

```
^SCFG: "Radio/Mtpl", <PL_mode>, <PL_profile>, <rba>, <PL_limit>
```

```
^SCFG: ["Radio/Mtpl", <PL_mode>, <PL_profile>, <rba>, <PL_limit>]
```

```
^SCFG: ["Radio/Mtpl",...]
```

In case of: <PL_mode>=2 full profile configuration (1-8) is printed out

```
^SCFG: "Radio/Mtpl", <PL_mode>, <PL_profile>, <rba>, <PL_limit>
```

```
^SCFG: ["Radio/Mtpl", <PL_mode>, <PL_profile>, <rba>, <PL_limit>]
```

```
^SCFG: ["Radio/Mtpl", <PL_mode>, <PL_profile>, <rba>, <PL_limit>]
```

```
^SCFG: ["Radio/Mtpl",...]
```

In case of: <PL_mode>=3 and all parameters set only the enabled profile is printed out

```
^SCFG: "Radio/Mtpl", <PL_mode>[, <PL_profile>]
```

OK

ERROR

```
+CME ERROR: <err>
```

Write Command

Configure allocation of serial interfaces:

```
AT^SCFG="Serial/Interface/Allocation"[, <reqSerialIfcAlloc>]
```

Response(s)

```
^SCFG: "Serial/Interface/Allocation", <curSerialIfcAlloc>, <reqSerialIfcAlloc>
```

OK

ERROR

```
+CME ERROR: <err>
```

Write Command

USB Device Descriptor:

```
AT^SCFG="Serial/USB/DDD" [, <deviceDescr>, [<descrIndex>], [<langId>], <vendorId>,  
<productId>, [<manufacturer>], [<product>], [<serialNo>]]
```

Response(s)

```
^SCFG: "Serial/USB/DDD", <deviceDescr>, <descrIndex>, <langId>, <vendorId>, <productId>,  
<manufacturer>, <product>, <serialNo>
```

OK

ERROR

+CME ERROR: <err>

Write Command

Select (U)SIM poll mode.

```
AT^SCFG="Sim/CCIN"[, <SimPollingMode>]
```

Response(s)

```
^SCFG: "Sim/CCIN", <SimPollingMode>
```

OK

ERROR

+CME ERROR: <err>

Write Command

Configure (U)SIM poll mode timer.

```
AT^SCFG="Sim/CCIN/Poll"[, <SimPollingTimer>]
```

Response(s)

```
^SCFG: "Sim/CCIN", <SimPollingTimer>
```

OK

ERROR

+CME ERROR: <err>

Write Command

Configure external or Component (U)SIM usage.

```
AT^SCFG="Sim/CS"[, <CS>]
```

Response(s)

```
^SCFG: "Sim/CS", <CS>
```

OK

ERROR

+CME ERROR: <err>

Write Command

Enable/disable IPv6 privacy extensions for the IP stack

```
AT^SCFG="Tcp/IPv6Priv"[, <v6privacyv>]
```

Response(s)

```
^SCFG: "Tcp/IPv6Priv", <v6privacyv>
```

OK

ERROR

+CME ERROR: <err>

Write Command

Enables/disables loopback device for the IOverAT services.

```
AT^SCFG="Tcp/Loop", <loopback>
```

Response(s)

```
^SCFG: "Tcp/Loop", <loopback>
```

OK

Write Command (Continued)

Enables/disables loopback device for the IOverAT services.

AT^SCFG="Tcp/Loop", <loopback>

Response(s)

ERROR

+CME ERROR: <err>

Write Command

Configuration of TCP parameter 'MaxRetransmissions':

AT^SCFG="Tcp/MR"[, <tcpMr>]

Response(s)

^SCFG: "Tcp/MR", <tcpMr>

OK

ERROR

+CME ERROR: <err>

Write Command

Configuration of TCP parameter 'OverallTimeout':

AT^SCFG="Tcp/OT"[, <tcpOt>]

Response(s)

^SCFG: "Tcp/OT", <tcpOt>

OK

ERROR

+CME ERROR: <err>

Write Command

Set a range of accepted TLS versions for the IOverAT services.

AT^SCFG="Tcp/TLS/Version", <TLS_min_version>, <TLS_max_version>

Response(s)

^SCFG: "Tcp/TLS/Version", <TLS_min_version>, <TLS_max_version>

OK

ERROR

+CME ERROR: <err>

Write Command

Enable/disable "destination unreachable response" for connect requests on non-opened TCP sockets (sockets with no listener running)

AT^SCFG="Tcp/UnreachRsp"[, <unreachv>]

Response(s)

^SCFG: "Tcp/UnreachRsp", <unreachv>

OK

ERROR

+CME ERROR: <err>

Write Command

Configuration of Internet Service URCs:

AT^SCFG="Tcp/WithURCs"[, <tcpWithUrc>]

Response(s)

^SCFG: "Tcp/WithURCs", <tcpWithUrc>

OK

ERROR

+CME ERROR: <err>

Write Command

Subcommand controls the behaviour of the RING line if it is selected for URC signalization.

AT^SCFG="URC/Ringline"[, <urcRinglineCfg>]

Response(s)

^SCFG: "URC/Ringline", <urcRinglineCfg>

OK

ERROR

+CME ERROR: <err>

Write Command

Subcommand controls duration of active RING line if it is selected for URC signalization.

AT^SCFG="URC/Ringline/ActiveTime"[, <urcRinglineDuration>]

Response(s)

^SCFG: "URC/Ringline/ActiveTime", <urcRinglineDuration>

OK

ERROR

+CME ERROR: <err>

PIN → Last

- ± -

Parameter Description

<g_mode>^{(str)(+CSCS)(NV)}

Mode of operation for signal lines

This parameter can be used to configure shared signal lines of the ELS31-V module. Depending on the connected devices the setting determines the specific function assigned to the related signal line(s). Keep in mind that the functions assigned to shared lines are mutually exclusive.

For example, to enable the SPI interface select `AT^SCFG="GPIO/mode/SPI", "std"`.

To enable, for example, the second serial interface ASC1 select `AT^SCFG="GPIO/mode/ASC1", "std"`.

The changes will take effect after restart of the UE and are non-volatile.

"std"	Signal lines are assigned to this interface.
"gpio"	Signal lines are used as GPIO.
"rsv"	Reserved value. Not supported by ELS31-V.

<cfun>^{(str)(NV)}

CFUN Mode

Parameter determines whether the `AT+CFUN` parameter <fun> values for Normal mode and Airplane mode are stored persistently.

"0" ^(D)	Setting of <code>AT+CFUN</code> parameter <fun> is stored persistently.
"1"	Setting of <code>AT+CFUN</code> parameter <fun> is volatile, i.e. changes are not reestablished after restart.

<cfun_save>^{(str)(NV)}

Saved CFUN Mode

Indicates `AT+CFUN` parameter <fun> which will be used for next UE restart.

<pingv>^{(str)(+CSCS)(NV)}

Enable ping response

Enable or disable response on PING. If module is connected to Internet and has valid IP address it will or will not respond to ICMP PING depending on this setting.

“0” Disable response on PING
“1“(D) Enable

<manufacturer>^{(str)(NV)}

Manufacturer name

Setting can be used to configure the name of the manufacturer which is displayed with the commands [ATI](#) and [AT+CGMI](#). Maximal length of the Manufacturer name is 25 characters (or less if you use multibyte characters).

“Cinterion“(D)

<product>^{(str)(NV)}

Product name

Setting can be used to configure the name of the product which is displayed with the commands [ATI](#) and [AT+CGMM](#). Maximal length of the product name is 25 characters (or less if you use multibyte characters).

“ELS31-V“(D)

<fso>^{(str)(+CSCS)(NV)}

Enable/disable fast switch off

This parameter configures a fast UE switch off, i.e., a shutdown without network deregistration. If enabled, the UE can be shut down without network deregistration by using either the AT command [AT^SMSO](#) or the hardware line [FAST_SHTDWN](#). For further details please refer to [\[2\]](#).

Please take great care before changing the fast switch off mode. Factory setting is `<fso>="0"`.

“0“(D) Fast UE switch off is disabled. [AT^SMSO](#) performs an orderly UE shutdown and issues the "[^SHUTDOWN](#)" URC. Triggering the [FAST_SHTDWN](#) line has no effect.

“1“ Fast UE switch off enabled. [AT^SMSO](#) performs the fast switch off and does not issue any reply, e.g., OK, ERROR or any "[^SHUTDOWN](#)" URC. Triggering the [FAST_SHTDWN](#) line will start the fast shutdown procedure.

<vthresh>^{(str)(NV)}

Undervoltage threshold value

The undervoltage thresholds defined for the BB (base band) domain are calculated for max. 400 mV voltage drops. Power supply sources for ELS31-V applications shall be designed to tolerate 400 mV voltage drops without crossing the lower limits of 3.3 V (BB). For ELS31-V applications operating at the limit of the allowed tolerance the default undervoltage threshold may be adapted by selecting a `<vthresh>` value.

New settings take effect after restart.

“-4“(D) 3.10 V
“-3“ 3.15 V
“-2“ 3.20 V
“-1“ 3.25 V
“0“ 3.30 V
“1“ 3.35 V
“2“ 3.40 V
“3“ 3.45 V
“4“ 3.50 V

<PowerSupplyDomain>^(str)

Power Supply Domain

"0" <vthresh> value applies to BB domain (BATT+_{BB} line).

<vthresh_BB_curr>^(str)

Current BB undervoltage threshold

"-4" ^(D)	3.10 V
"-3"	3.15 V
"-2"	3.20 V
"-1"	3.25 V
"0"	3.30 V
"1"	3.35 V
"2"	3.40 V
"3"	3.45 V
"4"	3.50 V

<vthresh_BB_request>^(str)

BB undervoltage threshold after next restart

For values see <vthresh_BB_curr>.

<rba>^{(str)(NV)}

Usage of <rba> depends on the AT^SCFG subcommand:

Using <rba> for AT^SCFG "Radio/Mtpl":

Parameter is mandatory within the profile specifying the module's output power limit. It shall be given as a single band within each profile (multiple band values as in the case of AT^SCFG "Radio/Band" are not accepted). For details see <PL_mode> and related parameters.

Using <rba> for AT^SCFG "Radio/Band":

Parameter determines the frequency band(s) the UE is allowed to use.

Please note that the band selection implementation of ELS31-V is based on a single band group that includes all frequency bands it is capable to use. This enables the UE to easily find a suitable network in any country around the world, no matter which frequency bands or band combinations and access technologies are present in a particular area.

Factory default of <rba> is the combination of all available bands meaning that all supported bands are allowed.

If AT+COPS equals "0" (automatic mode) this solution allows the subscriber to take advantage of a full-featured automatic network selection when trying to register.

Therefore, changes to the band configuration are recommended only if the subscriber wishes to restrict the allowed bands to a specific band or band combination, in particular to speed up the network search, and thus, to reduce the power consumption. In such case, <rba> may be one of the supported single values listed below or the sum of the values of all desired bands. For example, for LTE Band 4 ("65536") and LTE Band 13 ("33554432") please enter the value "33619968".

When changing the <rba> value you can use the additional <rbe> parameter to make the changes take effect immediately without reboot being required (<rbe>="1") or after reboot only (<rbe>="0").

"65536"	LTE 1700 (B4)
"33554432"	LTE 700 (B13)

<rbe>^(str)

Radio/Band: Set frequency band(s) immediately effective

The additional <rbe> parameter determines when a changed <rba> value becomes effective.

- “0“ <rba> takes effect after next restart.
- “1“ <rba> takes effect immediately and will also be effective after next restart. Setting a new <rba> value and <rbe>= 1 causes the UE to restart a network search and to deregister and re-register. If old and new <rba> are the same the command will be accepted without triggering a network search and without effect on the registration. <rbe>= 1 is not usable while the UE is set to AT+CFUN=0 or 4 (TX and RX RF switched off). In this case, the AT^SCFG write command returns an ERROR message.

<PL_mode>^(str)

Power Limitation Mode

The AT^SCFG subcommand "Radio/Mtpl" can be used to instantly adapt the module's Specific Absorption Rate (SAR) by reducing its output power for specific or all bands in any operating mode.

8 profiles for instant RF output power limitation can be defined and stored to the NV memory. A profile contains all supported bands (<rba>) and, for each single band, a parameter limiting the maximum RF output power (<PL_limit>). Changing limit values of a profile with <PL_mode> 3 takes effect after UE restart only. Activating and deactivating power limitation with <PL_mode> 1 or 0, takes effect instantly. The <PL_mode> is volatile, therefore output power limitation is deactivated after UE restart.

For an example on how to configure and trigger instant power limitation see below *Example* section.

- “0“(P) Power limitation deactivated (no further parameters are possible).
- “1“ Power limitation activated. <PL_profile> parameter is mandatory for activation.
- “2“ Query profile settings. The response shows the currently used limit values if instant power limitation is active, i.e. if <PL_mode>= 1. Therefore, bear in mind that modified profile values will be visible only if you restart the UE and run a query before activating instant power limitation. You can read either all profiles, or a specific profile by adding a <PL_profile> number.
- “3“ Change profile. All parameters are mandatory. Remember to restart the UE after changing the output power limits of a profile.

<PL_profile>^(str)

Power Limitation Profile

This parameter identifies the profile.

- 1...8 Number of profile.

<PL_limit>^{(str)(NV)}

Power Limitation

This parameter is used to set the power limit.

Setting takes effect after next restart.

- 18...23 Power limit value in dBm for LTE bands.

`<v6privacyv>`^{(str)(NV)}

Enable IPv6 privacy

Enable or disable IPv6 privacy extensions (RFC 4941) for the IP stack

"0"	Disable IPv6 privacy extensions
"1" ^(D)	Enable

`<loopback>`^(str)

IPOverAT loopback device

This parameter controls whether loopback device is enabled/disabled for IPOverAT services.

"disabled" ^(P)	Loopback device is disabled
"enabled"	Loopback device is enabled

`<tcpMr>`^{(str)(+CSCS)(NV)}

Maximum Number of Retransmissions (MR)

1...10 ^(D) ...30	This parameter determines the maximum number of times to retransmit TCP packets. The value set with <code><tcpMr></code> will be assumed as default for the <code><srvParm-Tag></code> "tcpMR" when a new service profile is created with <code>AT^SISS</code> . In each service profile, you can set another "tcpMR" value which has precedence over the global value set with <code>AT^SCFG</code> . Existing service profiles are not affected when you change the global value via <code>AT^SCFG</code> .
-----------------------------	--

`<tcpOt>`^{(str)(+CSCS)}

Overall TCP Timer for outstanding connections (tcpOT)

1...6000 ^(D)	This parameter specifies the number of seconds to wait before closing a connection if TCP/IP packets are not acknowledged. Setting the maximum value is practically equivalent to deactivating the tcpOT mechanism because the maximum time would never be reached by the TCP/IP stack. The value set with <code><tcpOt></code> will be assumed as default for the <code><srvParm-Tag></code> "tcpOT" when a new service profile is created with <code>AT^SISS</code> . However, in each service profile, you can set another "tcpOT" value which has precedence over the global value set with <code>AT^SCFG</code> . Existing service profiles are not affected when you change the global value via <code>AT^SCFG</code> . Parameter is non-volatile. Use of default value is recommended.
-------------------------	--

`<unreachv>`^{(str)(NV)}

Enable unreach response

Enable or disable response for open (SYN) requests on non-opened TCP sockets (no service is running on this socket). Normally, a SYN request on such a port is answered with a TCP packet, having set the RST bit in its header. Depending on this setting, the responding TCP packet is sent or not.

"0"	Disable response on non-opened sockets
"1" ^(D)	Enable

`<TLS_min_version>`^{(str)(NV)}

Minimum TLS Version allowed

This parameter sets the accepted minimum TLS version for IPOverAT services.

"MIN" ^(D)	Automatic minimum
"0.9"	TLSv0.9 (SSLv3)

"1.0"	TLSv1
"1.1"	TLSv1.1
"1.2"	TLSv1.2
"MAX"	Automatic maximum

`<TLS_max_version>`^{(str)(NV)}

Maximum TLS version allowed

This parameter sets the accepted maximum TLS version for IOverAT services. Must be equal or greater than `<TLS_min_version>`.

"1.0"	TLSv1
"1.1"	TLSv1.1
"1.2"	TLSv1.2
"MAX" ^(D)	Automatic maximum

`<tcpWithUrc>`^{(str)(+CSCS)(NV)}

URC mode or polling mode for Internet service commands

This parameter enables or disables the presentation of the following URCs related to Internet service commands: "`^SISR`" URC, "`^SISW`" URC and "`^SIS`" URC for parameter `<urcCause>`=0 (Internet service events). "`^SIS`" URCs with `<urcCause>`=1 or 2 used to indicate incoming Socket connections are always enabled.

"on" ^(D)	Enable URCs related to Internet service commands. Throughout the Chapter "Internet Service AT Commands" the mode is also referred to as URC mode.
"off"	Disable URCs related to Internet service commands. This requires the TE to employ polling techniques when using the Internet service AT commands: The TE is responsible to retrieve all status information needed to control an Internet session. The method is referred to as polling mode.

`<curSerialIfcAlloc>`^{(str)(+CSCS)(NV)}

Current Serial Interface Allocation

Parameter shows the current allocation of the serial interfaces. Configuration may be overwritten by the GPIO configuration done by the `AT^SCFG` parameters "GPIO/mode/...".

"0" ^(D)	AT commands are usable on ASC0 and USB. ASC1 is reserved for tracing by Gemalto M2M GmbH.
"1"	AT commands are usable on ASC0, ASC1 and USB.
"2"	AT commands are usable on ASC1 and USB. ASC0 is reserved for tracing by Gemalto M2M GmbH.

`<reqSerialIfcAlloc>`^{(str)(+CSCS)}

Requested Serial Interface Allocation

Parameter allows to configure the allocation of the serial interfaces. On powerup the requested configuration is the same as the current configuration. If the requested configuration becomes different to the current configuration, then it becomes active after restart.

"0" ^(D)	AT commands are usable on ASC0 and USB. ASC1 is reserved for tracing by Gemalto M2M GmbH.
"1"	AT commands are usable on ASC0, ASC1 and USB.
"2"	AT commands are usable on ASC1 and USB. ASC0 is reserved for tracing by Gemalto M2M GmbH.

`<deviceDescr>`^{(str)(+CSCS)(NV)}

Device Descriptor

This parameter determines whether to use the UE's standard USB Device Descriptor configuration (default) or a Device Descriptor configuration customized by the Customer Application manufacturer.

Setting will be active after ELS31-V restart.

- | | |
|--------------------|--|
| "0" ^(D) | Standard USB Device Descriptor of the UE.
If <code><deviceDescr>=0</code> is set all other parameters related to "Serial/USB/DDD" cannot be changed. For use in a Windows environment, the "usbmodem.inf" file delivered with ELS31-V shall be present.
Note that whenever the ELS31-V firmware is updated over the USB interface the UE's standard configuration must be present. Therefore, before starting a ELS31-V firmware download be sure that <code><deviceDescr>=0</code> is activated and, under Windows, the UE's "usbmodem.inf" file can be found. Remember to restart the UE after reverting to <code><deviceDescr>=0</code> and before starting the firmware download. |
| "1" | Customer specific USB Device Descriptor.
If <code><deviceDescr>=1</code> is set all other parameters related to "Serial/USB/DDD" can be changed.
Customizing the USB Device Descriptor configuration requires a unique Vendor ID obtained from the USB Implementers Forum. For information please refer to http://www.usb.org .
For use under Windows a customized INF file for the USB modem must be present. An easy way to create this file is copying the UE's "usbmodem.inf" file and overwriting the equivalent values changed with <code>AT^SCFG</code> , usually at least the Vendor ID, Product ID and, optionally, the manufacturer string. This is because the strings given for the customized "Serial/USB/DDD" parameters must be identical with those contained in the INF file. |

`<descrIndex>`^{(str)(+CSCS)(NV)}

Descriptor Index

As the ELS31-V shall be capable of holding 0 - 3 customized Device Descriptor configurations, the `<descrIndex>` allows to create and select different parameter sets consisting of the parameters listed below.

Please note that ELS31-V Release 4.3.2.0-25421 supports only one parameter set associated to value 0.

Setting will be active after ELS31-V restart.

Please note that this parameter is effective only if the customized Device Descriptor `<deviceDescr>=1` is enabled.

- | | |
|--------------------|--|
| "0" ^(D) | Index for the first descriptor definition. |
| "1" | Future use. |
| "2" | Future use. |
| "3" | Future use. |

`<langId>`^{(str)(+CSCS)(NV)}

Language ID

Please refer to [USB.ORG \[44\]](http://USB.ORG) to find the language IDs currently defined for USB devices. If parameter `<langId>` is not specified, the default value of the UE's standard USB Device Descriptor configuration applies (US English).

Setting will be active after ELS31-V restart.

Parameter length: maximum 4 characters.

Please note that this parameter is effective only if the customized Device Descriptor `<deviceDescr>=1` is enabled.

`<vendorId>(str)(+CSCS)(NV)`

Vendor ID

This parameter represents the Vendor ID obtained from the USB Implementers Forum. The Vendor ID will, together with the Product ID, be transmitted to the host during initialization. The given Vendor ID must be included in the INF file needed for Windows.

Setting will be active after ELS31-V restart.

Parameter length: maximum 4 characters.

Please note that this parameter is effective only if the customized Device Descriptor `<deviceDescr>=1` is enabled.

`<productId>(str)(+CSCS)(NV)`

Product ID

Product ID (PID) defined by the Customer Application manufacturer to identify the USB device.

The Product ID will, together with the Vendor ID, be transmitted to the host during initialization. The given Product ID must be included in the INF file needed for Windows.

Setting will be active after ELS31-V restart.

Parameter length: maximum 4 characters.

Please note that this parameter is effective only if the customized Device Descriptor `<deviceDescr>=1` is enabled.

`<manufacturer>(str)(+CSCS)(NV)`

Manufacturer name

Optional manufacturer string defined by the Customer Application manufacturer. If specified with `<manufacturer>` the same string shall be included in the INF file needed for Windows.

Setting will be active after ELS31-V restart.

Parameter length: maximum 63 characters.

Please note that this parameter is effective only if the customized Device Descriptor `<deviceDescr>=1` is enabled.

`<product>(str)(+CSCS)(NV)`

Product string

Optional product name defined by the Customer Application manufacturer. If specified with `<product>` it is recommended to include the same string into the INF file.

Setting will be active after ELS31-V restart.

Parameter length: maximum 63 characters.

Please note that this parameter is effective only if the customized Device Descriptor `<deviceDescr>=1` is enabled.

`<serialNo>(str)(+CSCS)(NV)`

Device's serial number

Optional serial number. Empty string if not used, like in the case of the UE'S standard USB Device Descriptor configuration.

A serial number has several advantages. For example, it enables the host to assign the same virtual COM port to same USB device even though the device is connected to another USB port. This eliminates the need for the host to load the driver again.

Setting will be active after ELS31-V restart. If parameter `<serialNo>` is not specified, the default value of UE's standard USB Device Descriptor applies.

Parameter length: maximum 63 characters.

Please note that this parameter is effective only if the customized Device Descriptor `<deviceDescr>=1` is enabled.

<SimPollingMode>^{(str)(+CSCS)(NV)}

(U)SIM polling mode

- “0”^(D) (U)SIM polling timer disabled, therefore CCIN must be connected to the card holder, and the (U)SIM can be removed during operation. See [2] for detailed guidelines.
- “1” (U)SIM polling timer enabled. The UE will poll for the presence of the (U)SIM. (U)SIM cannot be removed independently of the CCIN connection.

<SimPollingTimer>^{(str)(+CSCS)(NV)}

(U)SIM polling timer period

- 100...1000^(D)...65556 Specifies the (U)SIM polling timer period in milliseconds when <SimPollingMode> is 1.

<CS>^{(str)(NV)}

Card slot / (U)SIM

The AT^SCFG subcommand "SIM/CS" specifies the (U)SIM interface currently used. Usage of this command depends on whether the host application is designed to include an additional second (U)SIM interface. Only one of the supported (U)SIM interfaces can be used at a time. For details on how to connect the first and the second (U)SIM interface please refer to [2].

- “SIM1”^(D) First (U)SIM slot is enabled regardless of whether a (U)SIM card is inserted. Access to another (U)SIM inserted in slot 2 is deactivated.
- “SIM2” Second (U)SIM slot is enabled regardless of whether a (U)SIM card is inserted. Access to another (U)SIM inserted in slot 1 is deactivated.

<urcRinglineCfg>^{(str)(+CSCS)(NV)}

Parameter specifies the ring line to be used for signaling URCs both for idle interface and while interface is reserved, i.e. while busy on AT command execution or data transmission.

For details about URC presentation refer to Section 1.7, [Unsolicited Result Code Presentation](#).

For details on using the RING0 line to wake up the TE refer to [2].

Setting is global for all interfaces.

- “off” URCs are not indicated by a ring line.
- “local”^(D) URCs are indicated by an activated ring line on the same interface where the URC appears.
- “asc0” URCs are indicated by activated RING0 line of the ASC0 interface (low active).

<urcRinglineDuration>^{(str)(+CSCS)(NV)}

This parameter determines how long the ring line is activated in order to indicate a URC. For details about URC presentation refer to Section 1.7, [Unsolicited Result Code Presentation](#). For more information on the RING0 line and its timing for different types of URCs please refer to [2]. <urcRinglineDuration> is applicable to all types of URCs except the RING URC. The timing of the RING URC (incoming calls) is not configurable by AT command.

The type of ring line used for URC indication depends on parameter <urcRinglineCfg>.

Setting is global for all interfaces.

- “0” RING line will be activated for about 5 s
- “1” RING line will be activated for about 100 ms.
- “2”^(D) RING line will be activated for about 1 s.

Examples

EXAMPLE 1

Usage of "URC/Ringline":

AT+CSCS="GSM"	Switch to GSM character set.
OK	
AT^SCFG?	Query all parameters.
...	
^SCFG:"URC/Ringline","local"	URCs on this interface will be indicated by Ring line associated to the interface (e.g. RING0 for ASC0).
...	
OK	
AT^SCFG="URC/Ringline","asc0"	
^SCFG:"URC/Ringline","asc0"	URCs on <i>this</i> interface will be indicated by an activated RING0 no matter whether or not the UE-TE link is reserved.
OK	
AT^SCFG="URC/Ringline","off"	Disable any Ring line indication for URCs on this interface.
^SCFG:"URC/Ringline","off"	
OK	

EXAMPLE 2

The example shows how to read, configure, activate and deactivate output power limitation using the [AT^SCFG "Radio/Mtpl"](#) subcommand. See parameters [<PL_mode>](#), [<PL_profile>](#), [<PL_limit>](#) and [<rba>](#).

^SYSSTART	
AT^SCFG="Radio/Mtpl"	Read "Radio/Mtpl" mode.
^SCFG: "Radio/Mtpl","0"	Instant power limitation is still disabled.
OK	
AT^SCFG="Radio/Mtpl",2,1	Read profile 1 settings. Delivery default settings are shown:
^SCFG: "Radio/Mtpl","2","1","65536","23"	
^SCFG: "Radio/Mtpl","2","1","33554432","23"	
OK	
AT^SCFG="Radio/Mtpl",3,1,65536,21	Profile 1: Change max. RF output power limit of LTE 1700 (B4) band to 21dBm.
^SCFG: "Radio/Mtpl","0"	Instant power limitation is still disabled.
OK	
AT^SCFG="Radio/Mtpl",3,1,33554432,21	Profile 1: Change max. RF output power limit of LTE 700 (B13) band to 21dBm.
^SCFG: "Radio/Mtpl","0"	Instant power limitation is still disabled.
OK	
AT^SCFG="Radio/Mtpl",2,1	Read profile 1 settings.
.....	The response returns the old values as above (therefore omitted in this example).
AT+CFUN=1,1	Restart UE to enable the profile 1 settings configured above.
OK	
^SYSSTART	
AT^SCFG="Radio/Mtpl"	Read "Radio/Mtpl" mode.
^SCFG: "Radio/Mtpl","0"	Instant power limitation is still disabled.
OK	
AT^SCFG="Radio/Mtpl",2,1	Read profile 1 settings. Changed values are shown now.
^SCFG: "Radio/Mtpl","2","1","65536","21"	
^SCFG: "Radio/Mtpl","2","1","33554432","21"	
OK	

```
AT^SCFG="Radio/Mtpl",1,1  
^SCFG: "Radio/Mtpl","1","1"
```

Activate Profile 1.
Instant power limitation is now enabled with profile 1 and new limits as changed above.

```
OK  
AT^SCFG="Radio/Mtpl",1,2  
^SCFG: "Radio/Mtpl","1","2"
```

Switch profiles, and activate profile 2.
Instant power limitation is now enabled with profile 2, still using delivery default values.

```
OK  
AT^SCFG="Radio/Mtpl",0  
^SCFG: "Radio/Mtpl","0"  
OK
```

Deactivate instant power limitation.
Instant power limitation is now disabled.

2.12 AT^SPOW Set UART Mode and SLEEP Mode on UART

[AT^SPOW](#) enables or disables the UE's UART interfaces ASC0 and ASC1 and controls SLEEP mode on both interfaces. Parameter settings are non-volatile and common for all interfaces, but are not effective for USB.

If SLEEP mode is enabled ([<mode>](#)=2), RTS0 and RTS1 are used by the TE to signal the UE to wake up. SLEEP mode requires that CTS/RTS flow control be configured both on UE side (see [AT\Q](#)) and TE side.

If SLEEP mode is enabled on ASC0 and ASC1, keep in mind that the module's current consumption decreases only if USB is either disconnected at all, or in Suspend state with VUSB_IN line enabled. Please refer to "[ELS31-V Hardware Interface Description, Version 4.3.2.0-25421](#)" for more information on power saving.

Syntax

Test Command

```
AT^SPOW=?
```

Response(s)

```
^SPOW: (list of supported <mode>s), (time range of <timeout>)
```

```
OK
```

```
ERROR
```

```
+CME ERROR: <err>
```

Read Command

```
AT^SPOW?
```

Response(s)

```
^SPOW: <mode>, <timeout>
```

```
OK
```

```
ERROR
```

```
+CME ERROR: <err>
```

Write Command

```
AT^SPOW=<mode>, <timeout>
```

Response(s)

```
OK
```

```
ERROR
```

```
+CME ERROR: <err>
```

PIN → Last

- + -

Parameter Description

[<mode>](#)^{(num)(NV)}

0	UART interfaces ASC0 and ASC1 are deactivated to reduce power consumption. They can be activated again by changing <mode> from the USB interface.
1	UART interfaces ASC0 and ASC1 are activated.
2 ^(D)	UART interfaces ASC0 and ASC1 are in a power saving mode, i.e., in SLEEP mode.

<timeout>^{(num)(NV)}

0	Value 0 applies only to <mode>=0 or 1.
100...5000 ^(D) ...10000	In SLEEP mode (<mode>=2), time in milliseconds the UE remains awake after the last sent character. Minimum value: 100 ms, recommended 5000 ms. <timeout> values below 100 are denied with ERROR.

Note

- The change of <mode> takes effect after restart of the UE, e.g. with AT+CFUN=1,1.

3. Status Control Commands

The AT Commands described in this chapter allow the external application to obtain various status information from the ELS31-V.

3.1 AT+CEER Extended Error Report

AT+CEER returns an extended error report regarding the reason of the last

- EMM failure
- ESM failure

Example:

```
+CEER: lastEmmCause: PLMN_NOT_ALLOWED, lastEsmCause: UNKNOWN_PDN_TYPE
```

Syntax

<p>Test Command</p> <pre>AT+CEER=?</pre> <p>Response(s)</p> <pre>OK ERROR +CME ERROR: <err></pre>	
<p>Exec Command</p> <pre>AT+CEER</pre> <p>Response(s)</p> <pre>+CEER: <lastEmmCause>, <lastEsmCause> OK ERROR +CME ERROR: <err></pre>	
<p>Write Command</p> <pre>AT+CEER=<reset></pre> <p>Response(s)</p> <pre>OK ERROR +CME ERROR</pre>	
<p>PIN → Last</p> <pre>- + -</pre>	<p>Reference(s)</p> <p>3GPP TS 27.007 [39]</p>

Parameter Description

<lastEmmCause>^(num)

Verbose string containing the textual representation of the last EMM failure cause.

<lastEsmCause>^(num)

Verbose string containing the textual representation of the last ESM failure cause.

3.1 AT+CEER

`<reset>^(num)`

0 Reset the extended error report to initial value.

3.1.1 Release Causes for EMM Failures

<code><lastEmmCause></code> ID	Description
103	Illegal UE
106	Illegal ME
107	EPS service not allowed

3.1.2 Release Causes for ESM Failures

<code><lastEsmCause></code> ID	Description
8	OPERATOR_DETERMINED_BARRING
26	INSUFFICIENT_RESOURCES
27	UNKNOWN_OR_MISSING_APN
28	UNKNOWN_PDN_TYPE
29	USER_AUTHENTICATION_FAILED
30	ACTIVATION_REJECTED_BY_GW
31	ACTIVATION_REJECTED_UNSPECIFIED
32	SERVICE_OPTION_NOT_SUPPORTED
33	REQUESTED_SERVICE_OPTION_NOT_SUBSCRIBED

3.2 AT^SIND Extended Indicator Control

AT^SIND controls the presentation of indicator event URCs. You can enable or disable URCs to be issued by the ELS31-V each time the value of the related indicator changes, you can request the current status of all indicators, and you can also query the status of a single indicator.

Syntax

Test Command

AT^SIND=?

Response(s)

```
^SIND: (<indDescr>, list of supported <indValue>s)[, (<indDescr>, list of supported <indValue>s)[,
...]], (list of supported <mode>s)
OK
```

Read Command

AT^SIND?

Response(s)

```
^SIND: <indDescr>, <mode>[, <indValue>]
[^SIND: <indDescr>, <mode>[, <indValue>]]
...

If <indDescr>="nitz":
^SIND: nitz, <mode>, <nitzUT>, <nitzTZ>, <nitzDST>

If <indDescr>="is_cert":
^SIND: is_cert, <mode>[, <srvProfileId>, <issuer>, <serialNumber>, <subject>,
<signatureAlgorithm>, <thumbprintAlgorithm>, <thumbprint>]
...
OK
ERROR
+CME ERROR: <err>
```

Write Command

AT^SIND=<indDescr>, <mode>

Response(s)

```
^SIND: <indDescr>, <mode>[, <indValue>]

If <indDescr>="nitz" and <mode>=2
^SIND: <indDescr>, <mode>, <nitzUT>, <nitzTZ>, <nitzDST>

If <indDescr>="is_cert" and <mode>=1 or 2:
^SIND: is_cert, <mode>[, <srvProfileId>, <issuer>, <serialNumber>, <subject>,
<signatureAlgorithm>, <thumbprintAlgorithm>, <thumbprint>]
...
OK
ERROR
+CME ERROR: <err>
```

PIN → Last

- + -

Unsolicited Result Codes

URC 1

Format of the standard indicator:

+CIEV: `<indDescr>`, `<indValue>`

Value of an indicator has changed.

URC 2

Format of the "simdata" indicator:

+CIEV: `<indDescr>`

This URC is issued indicating that the content of one or more (U)SIM Elementary Files has been changed.

URC 3

Format of the "nitz" indicator:

+CIEV: `<indDescr>`, `<nitzUT>`, `<nitzTZ>`, `<nitzDST>`

URC 4

Format of the "is_cert" indicator:

+CIEV: `<indDescr>`, `<srvProfileId>`, `<issuer>`, `<serialNumber>`, `<subject>`,
`<signatureAlgorithm>`, `<thumbprintAlgorithm>`, `<thumbprint>`

The URC is issued after opening a secure Internet connection with `AT^SISO`.

Parameter Description

`<indDescr>`^(str)

This section describes `<indDescr>` values and their associated `<indValue>` ranges.

For command input on the `AT^SIND` write command line `<indDescr>` values are handled as string type. In responses and URCs `<indDescr>` values are output without quotation marks.

"service"	Service availability: 0 Not registered to any network. 1 Registered to home network or, if "roam"=1 then registered to another network.
"message"	Unread short message at memory location <code><mem1></code> . Refer to <code>AT+CPMS</code> . 0 No unread message(s) available. 1 Unread message(s) available.
"roam"	Roaming indicator: 0 Registered to home network or not registered. 1 Registered to other network.
"smsfull"	Capacity of storage for received short messages: 0 The short message memory location <code><mem3></code> is still free or has just become free again. Refer to <code>AT+CPMS</code> . 1 All memory locations of <code><mem3></code> are used up.
"rsi"	Received signal (field) strength: 0 Signal strength \leq -112 dBm 1 - 4 Signal strength in 15 dB steps 5 Signal strength \geq -51 dBm 99 Signal strength not known or not detectable
"simdata"	(U)SIM notifies of changed Elementary File data: All data provided by the (U)SIM is stored in one of many of its so-called Elementary Files. Be aware that this Elementary File data can be changed at any time by the net-

3.2 AT^SIND

work provider or an application running on the (U)SIM. Therefore, a "+CIEV: "simdata"" URC is issued if (U)SIM sent a SAT REFRESH command indicating that the content of one or more Elementary Files has been changed.

"nitz"

Network Identity and Time Zone indication:

This indicator shows the time relevant information elements of an MM Information (MMI) or GMM Information (GMMI) message received from the network (see 3GPP TS 24.008 [33], ch. 9.2.15a and 9.4.19). The network usually sends a NITZ indicator when the mobile attaches to the network, when it enters a location area with different time zone or when a daylight change occurs.

A NITZ indicator may consist of the following parameters: Universal Time (UT), local Time Zone (TZ), Daylight Saving Time (DST). All information elements of MMI/GMMI are optional and therefore, the presentation of the parameters <nitzUT>, <nitzTZ>, <nitzDST> varies with the network. For example, the network may send all three parameters UT, TZ, DST, or only UT and TZ or only TZ.

UT is indicated in usual date/time format and represents the current world time (GMT) at the moment when sent.

TZ is given as a positive (east) or negative (west) offset from UT in units of 15 minutes.

DST shows the number of hours added to the local TZ because of daylight saving time (summertime) adjustment. Usually DST is 1 hour but it can be also 2 hours in certain locations.

Example for time and time zone with DST:

+CIEV: nitz,"04/07/23,13:39:20",-28,1

In this example TZ is -28, showing a time offset of -7 hours (west) to Universal Time/GMT (which never changes for DST). DST is 1 which indicates that one hour was added to TZ because of Daylight Saving Time. If a network does not send the DST parameter the TZ value would be -32 (8 hours west) as would be done in winter:

+CIEV: nitz,"04/11/23,13:39:20",-32

Please be aware that although the last NITZ value can be looked up again via "AT^SIND=nitz,2" the returned values may be out of date. Especially the UT value is obsolete because there is no internal NITZ clock and therefore no continuation of UT.

NITZ values are lost when the UE detaches from network. Also when a manual network selection fails and the UE automatically falls back to the previous network the NITZ values cannot be recalled. Nevertheless an indicated time zone is valid until a new MMI/GMMI will trigger another NITZ indication.

"psinfo"

Packet Switched Status Indication

"psinfo" indicates the status of the UE related to packet switched data calls.

0	PDN not (yet) found
16	Camped on EUTRAN capable cell
17	Attached in EUTRAN capable cell

"simtray"

Indication of (U)SIM tray status as indicated by CCIN line. Result does not depend on whether the tray holds a (U)SIM or not.

Generating a URC on status change is not supported.

0	(U)SIM tray empty.
1	(U)SIM tray plugged in.

"euiccid"

(U)SIM embedded identification number:

"euiccid" delivers the (U)SIM embedded identification number retrieved from the (U)SIM Elementary File EF_{EUICCID}.

“is_cert“ Report details of the server certificate used for a secure Internet connection opened with AT^SISO.
The following certificate details are listed: <srvProfileId>, <issuer>, <serialNumber>, <subject>, <signatureAlgorithm>, <signatureAlgorithm>, <thumbprintAlgorithm>, <thumbprint>
Detailed guidelines for managing the required certificates can be found in [4].
See also AT commands AT^SISS, AT^SBNR and AT^SBNW.

<indValue>^(num)

Integer type value in the range stated above for the corresponding <indDescr>.

<mode>^(num)

Set or query URC presentation mode of a specific indicator <indDescr>.

- 0^(P) Disables the presentation of a specific URC.
- 1 Enables the presentation of a specific URC. The URC will be buffered in the UE when the UE-TE link is reserved (e.g. in online data mode), and flushed to the TE when the UE-TE link is free again. Otherwise, the URC will be forwarded directly to the TE.
- 2 Requests the presentation mode of the URC status and the current value of a single indicator type.

<nitzUT>^{(str)(+CSCS)}

Universal Time delivered as part of the "nitz" Indicator. Refer to <indDescr>.

<nitzTZ>^(num)

Time Zone delivered as part of the "nitz" Indicator. Refer to <indDescr>.

<nitzDST>^(num)

Adjustment for Daylight Saving Time as part of the "nitz" Indicator. Refer to <indDescr>.

<srvProfileId>^(num)

Internet service profile identifier. Refer to AT^SISS, <srvProfileId>.

<issuer>^(str)

Certificate's issuer. Refer to <indDescr>.

<serialNumber>^(str)

Certificate's serial number. Refer to <indDescr>.

<subject>^(str)

Certificate's subject. Refer to <indDescr>.

<signatureAlgorithm>^(str)

Certificate's signature algorithm. Refer to <indDescr>.

<thumbprintAlgorithm>^(str)

Certificate's thumbprint algorithm. Refer to <indDescr>.

`<thumbprint>(str)`

Certificate's thumbprint. Refer to [<indDescr>](#).

3.3 AT+CPAS Activity Status

AT+CPAS execute command queries ELS31-V's activity status.

Syntax

Test Command	
AT+CPAS=?	
Response(s)	
+CPAS: (list of supported <pas>s)	
OK	
Exec Command	
AT+CPAS	
Response(s)	
+CPAS: <pas>	
OK	
PIN → Last	Reference(s)
- + -	3GPP TS 27.007 [39]

Parameter Description

<pas> ^(num)	
0	Ready
4	RRC connected state
5	Asleep

3.4 AT+WS46 Select wireless network

Syntax

Test Command

AT+WS46=?

Response(s)

(list of supported<n>s)

OK

Read Command

AT+WS46?

Response(s)

<n>

OK

Write Command

AT+WS46=<n>

Response(s)

OK

ERROR

+CME ERROR: <err>

PIN → Last

- + -

Reference(s)

3GPP TS 27.007 [39]

Parameter Description

<n>^(num)

28

E-UTRAN only

4. Serial Interface Control Commands

The AT Commands described in this chapter allow the external application to determine various settings related to the ELS31-V's serial interface.

4.1 AT\Q Flow Control

[AT\Q](#) allows to configure flow control on the ELS31-V's asynchronous serial interface ASC0 and ASC1. [AT\Q](#) setting is always common for all interfaces and can be changed, for compatibility reasons, on each interface, but is only applicable to ASC0 and ASC1.

[AT\Q](#) settings have no effect on the USB ports because the USB protocol integrates a flow control mechanism of its own.

Syntax

```
Exec Command
AT\Q[<n>]
Response(s)
OK

PIN → Last
- + -
```

Parameter Description

<code><n></code> ^{(num)(&V)(&W)}	Description
0 - 2	These values are accepted, but don't have any effect. AT\Q setting is always reported as <code><n>3</code> in the active profile (see AT&V).
<code>[3]</code> ^{(&F)(D)}	RTS/CTS hardware flow control

4.2 AT&C Set Data Carrier Detect (DCD) Line Mode

The [AT&C](#) command controls the behavior of the UE's DCD line.

[AT&C](#) offers full functionality only if the DCD0 line is enabled with [AT^SCFG](#)="GPIO/mode/DCD0","std". Otherwise [AT&C](#) will respond "+CME ERROR: operation not allowed".

Syntax

Exec Command		
AT&C[<value>]		
Response(s)		
OK		
PIN	→ Last	Reference(s)
-	+	-
		V.250

Parameter Description

<value> ^{(num)(&V)(&W)}	
[0]	DCD line shall always be on.
1(&F)	DCD line shall be on only when data carrier signal is present.
2	DCD line shall be on when one or more Internet services defined on the related serial channel are in state "Connecting" or "Up" as described below. For details on the various service states refer to AT^SISI , parameter <srvState> or AT^SISO , parameter <srvState>. <ul style="list-style-type: none"> • Transparent TCP or Transparent UDP client, SOCKET, HTTP, SMTP: DCD shall be on when <srvState>="Connecting" or "Up" • Transparent TCP Listener: DCD shall be on when <srvState>="Connected" • FTP: DCD shall be on when data channel is connected, i.e. <srvState>="Up"

4.3 AT&D Set Data Terminal Ready (DTR) Line Mode

AT&D determines how the UE responds if the DTR line is changed from ON to OFF state during data connection (PPP or active Internet Services transparent access mode; refer to [AT^SIST](#)).

AT&D offers full functionality only if the DTR0 line is enabled with **AT^SCFG="GPIO/mode/DTR0", "std"**. Otherwise **AT&D** will respond "+CME ERROR: operation not allowed".

Syntax

Exec Command		
AT&D[<value>]		
Response(s)		
OK		
PIN → Last		Reference(s)
- + -		V.250

Parameter Description

<value> ^{(num)(&V)(&W)}	Description
[0]	UE ignores status of the DTR line.
1	ON->OFF on DTR: Change to command mode while retaining the data connection.
2 ^(&F)	ON->OFF on DTR: Disconnect the data connection (only for PPP) and change to command mode. For Internet service the behaviour is like AT&D1 .

4.4 AT&S Set Data Set Ready (DSR) Line Mode

AT&S determines how the UE sets the DSR line depending on its communication state.

AT&S offers full functionality only if the DSR0 line is enabled with `AT^SCFG="GPIO/mode/DSR0","std"`. Otherwise **AT&S** will respond "+CME ERROR: operation not allowed".

Syntax

Exec Command	
AT&S[<value>]	
Response(s)	
OK	
PIN → Last	Reference(s)
- + -	ITU-T V.250 [9]

Parameter Description

<value> ^{(num)(&V)(&W)}	
[0] ^(&F)	DSR line is always ON
1	UE in command mode: DSR is OFF. UE in data mode: DSR is ON.

4.5 ATE AT Command Echo

ATE controls if the ELS31-V echoes characters received from TE during AT command state.

Syntax

Exec Command	
ATE[<value>]	
Response(s)	
OK	
PIN → Last	Reference(s)
- + -	V.250

Parameter Description

<value> ^{(num)(&V)(&W)}	
[0]	Echo mode off
1 ^(&F)	Echo mode on

4.6 AT+ICF Character Framing

AT+ICF controls character framing and parity format used for receiving and transmitting data via ELS31-V's asynchronous serial interfaces (UART).

Following settings are supported:

- 7 bits, even parity, 1 stop bit (**AT+ICF=5,1**)
- 7 bits, odd parity, 1 stop bit (**AT+ICF=5,0**)
- 8 bits, even parity, 1 stop bit (**AT+ICF=2,1**)
- 8 bits, no parity, 1 stop bit (**AT+ICF=3**)
- 8 bits, odd parity, 1 stop bit (**AT+ICF=2,0**)
- 8 bits, no parity, 2 stop bits (**AT+ICF=1**)

Changed **AT+ICF** settings take effect after restart. This requires storing any changes with **AT&W**.

If the current **<format>** setting uses no parity (e.g. **<format>=3**) and **AT+ICF** is used to switch to a format with parity (e.g. **<format>=2**), it is necessary to explicitly set parameter **<parity>**, e.g. **AT+ICF=2,1**. If not done correctly ELS31-V will respond with "+CME ERROR: invalid index". This is because for **<format>=3**, the parameter **<parity>** is set to the internal value 'no parity' which is not supported by **<format>=2**. Please remember that if an optional parameter is omitted for which no default is stated in this document, the value of the parameter remains unchanged.

Syntax

<p>Test Command</p> <p>AT+ICF=?</p> <p>Response(s)</p> <p>+ICF: (list of supported <format>s), (list of supported <parity>s)</p> <p>OK</p>	
<p>Read Command</p> <p>AT+ICF?</p> <p>Response(s)</p> <p>+ICF: <format>[, <parity>]</p> <p>OK</p>	
<p>Write Command</p> <p>AT+ICF=[<format>[, <parity>]]</p> <p>Response(s)</p> <p>OK</p> <p>ERROR</p> <p>+CME ERROR: <err></p>	
<p>PIN → Last</p> <p>- + +</p>	<p>Reference(s)</p> <p>V.250</p>

Parameter Description

<format> ^{(num)(&V)(&W)}	
1	8 data 0 parity 2 stop
2	8 data 1 parity 1 stop

3(&F)(D)	8 data 0 parity 1 stop
5	7 data 1 parity 1 stop

`<parity>^(num)(&V)(&W)`

Specifies the method of calculating the parity bit, if a parity bit is supported by `<format>`.
If `<format>` does not support parity, this parameter has to be omitted.

0	odd
1	even

Note

- Generally, `AT+ICF` should be used as a standalone command as specified in Section 1.4.2, [Concatenating AT Commands](#).
If nevertheless combinations with other commands on the same command line cannot be avoided, there are several constraints to be considered:
 - Avoid combinations with the AT commands listed in Section 1.4.2, [Concatenating AT Commands](#).
 - Keep in mind that there shall be a minimum pause between two AT commands as specified in Section 1.5, [Communication between Customer Application and ELS31-V](#).
 - If switching to the new character framing takes effect while a response is being transmitted, the last bytes may be sent with the new character framing and thus, not properly transmitted. The following commands will be correctly sent at the new character framing.
Please consider this effect especially when local echo is active (`ATE1`).

4.7 AT+IPR Bit Rate

AT+IPR allows to query and set the bit rate of the ELS31-V's asynchronous serial interface (UART).
The test command returns the values of supported fixed bit rates.
The read command returns the current bit rate of the interface.
The write command determines the bit rate to be used for the interface.

It is not recommended to set bit rates lower than 9600 bps in order to avoid timing problems (see Section 1.5, [Communication between Customer Application and ELS31-V](#) for details about timing).
It is highly recommended to use **AT+IPR** as a standalone AT command, i.e. better do not combine with other commands on the same AT command line.
The current setting of **AT+IPR** will be preserved after firmware download (i.e. a firmware update does not restore the factory setting), or in the event of power failure.

Syntax

<p>Test Command</p> <p>AT+IPR=?</p> <p>Response(s)</p> <p>+IPR: () , (list of supported selectable <rate>s)</p> <p>OK</p>	
<p>Read Command</p> <p>AT+IPR?</p> <p>Response(s)</p> <p>+IPR: <rate></p> <p>OK</p>	
<p>Write Command</p> <p>AT+IPR=<rate></p> <p>Response(s)</p> <p>OK</p> <p>ERROR</p> <p>+CME ERROR: <err></p>	
<p>PIN → Last</p> <p>- + -</p>	<p>Reference(s)</p> <p>V.250</p>

Parameter Description

<p><rate>^{(num)&(V)(NV)}</p> <p>Bit rate per second (bps)</p> <p>4800</p> <p>9600</p> <p>19200</p> <p>115200^(D)</p> <p>230400</p> <p>460800</p> <p>921600</p>	
---	--

Note

- Generally, [AT+IPR](#) should be used as a standalone command as specified in Section [1.4.2, Concatenating AT Commands](#).
If nevertheless combinations with other commands on the same command line cannot be avoided, there are several constraints to be considered:
 - Avoid combinations with the AT commands listed in Section [1.4.2, Concatenating AT Commands](#).
 - Keep in mind that there shall be a minimum pause between two AT commands as specified in Section [1.5, Communication between Customer Application and ELS31-V](#).
 - If switching to the new bit rate takes effect while a response is being transmitted, the last bytes may be sent with the new bit rate and thus, not properly transmitted. The following commands will be correctly sent at the new bit rate.
Please consider this effect especially when local echo is active ([ATE1](#)).

5. Identification Commands

The AT Commands described in this chapter allow the external application to obtain various identification information related to the ELS31-V and linked entities.

5.1 ATI Display product identification information

The [ATI](#) execute command delivers a product information text.

Syntax

Exec Command	ATI	Response(s)	Cinterion ELS31-V REVISION <revUE> OK
Exec Command	ATI1	Response(s)	Cinterion ELS31-V REVISION <revUE> A-REVISION <revApp> L-REVISION <revLinux> OK
Exec Command	ATI176	Response(s)	<imeisv_number> OK
PIN → Last	- + -	Reference(s)	ITU-T V.250 [9]

Parameter Description

<revUE>^(num)

Revision of UE in the format X.Y.Z.T, where X.Y.Z.T are numbers.

<revApp>^(num)

Revision of Application software in the format X.Y.Z.T-V, where X, Y, Z, T and V are numbers.

<revLinux>^(num)

Revision of embedded Linux kernel in the format X.Y.Z, where X, Y, Z are numbers.

`<imeisv_number>(num)`

IMEISV (International Mobile station Equipment Identity and Software Version number) conforming to the format: <IMEI>.<SVN>. For information on IMEISV refer to 3GPP TS 23.003 and 3GPP TS 27.007 [\[39\]](#).

5.2 AT+CGMI Request manufacturer identification

[AT+CGMI](#) returns a manufacturer identification text.

Syntax

Test Command	
AT+CGMI=?	
Response(s)	
OK	
Exec Command	
AT+CGMI	
Response(s)	
Cinterion	
OK	
PIN → Last	Reference(s)
- + -	3GPP TS 27.007 [39]

5.3 AT+CGMM Request model identification

[AT+CGMM](#) returns a product model identification text.

Syntax

Test Command	
AT+CGMM=?	
Response(s)	
OK	
Exec Command	
AT+CGMM	
Response(s)	
ELS31-V	
OK	
PIN → Last	Reference(s)
- + -	3GPP TS 27.007 [39]

5.4 AT+CGMR Request revision identification of software status

[AT+CGMR](#) delivers a product firmware version identification.

Syntax

Test Command	
AT+CGMR=?	
Response(s)	
OK	
Exec Command	
AT+CGMR	
Response(s)	
REVISION <revUE>	
OK	
PIN → Last	Reference(s)
- + -	3GPP TS 27.007 [39]

Parameter Description

<revUE> ^(str)
Revision of UE in the format X.Y.Z.T, where X.Y.Z.T are numbers.

5.5 AT+CGSN Request International Mobile Equipment Identity (IMEI)

AT+CGSN delivers the International Mobile Equipment Identity (IMEI). Command is identical with: [AT+GSN](#).

Syntax

Test Command

```
AT+CGSN=?
```

Response(s)

```
OK
```

Exec Command

```
AT+CGSN
```

Response(s)

```
<sn>
```

```
OK
```

Write Command

```
AT+CGSN=<snt>
```

Response(s)

```
If <snt>=0
```

```
<sn>
```

```
OK
```

```
ERROR
```

```
+CME ERROR: <err>
```

Write Command

```
AT+CGSN=<snt>
```

Response(s)

```
If <snt>=1
```

```
+CGSN: <sn>
```

```
If <snt>=2
```

```
+CGSN: <imeisv_number>
```

```
If <snt>=3
```

```
+CGSN: <SVN>
```

```
OK
```

```
ERROR
```

```
+CME ERROR: <err>
```

PIN → Last

```
- + -
```

Reference(s)

3GPP TS 27.007 [39]

Parameter Description

<sn>^(str)

International Mobile Equipment Identity (IMEI) identifying a mobile equipment used in the mobile network. IMEI is composed of Type Allocation Code (TAC) (8 digits), Serial Number (SNR) (6 digits) and the Check Digit (CD) (1 digit). For information on IMEI refer to 3GPP TS 23.003, subclause 6.2.1 and 3GPP TS 27.007 [39].

<snt>^(num)

Integer type indicating the serial number type that has been requested.

<imeisv_number>^(num)

IMEISV (International Mobile station Equipment Identity and Software Version number).

The 16 digits of IMEISV are composed of Type Allocation Code (TAC) (8 digits), Serial Number (SNR) (6 digits) and the software version (SVN) (2 digits). For information on IMEISV refer to 3GPP TS 23.003, subclause 6.2.2 and 3GPP TS 27.007 [39].

<SVN>^(num)

Current SVN which is a part of IMEISV; refer 3GPP TS 23.003, subclause 6.2.2 and 3GPP TS 27.007 [39]. This allows identifying different software versions of a given mobile.

5.6 AT+GSN Request International Mobile Equipment Identity (IMEI)

AT+GSN delivers the International Mobile Equipment Identity (IMEI). Command is identical with **AT+CGSN**

Syntax

Test Command

AT+GSN=?

Response(s)

OK

Exec Command

AT+GSN

Response(s)

<sn>

OK

Write Command

AT+GSN=<snt>

Response(s)

If <snt>=0

<sn>

OK

ERROR

+CME ERROR: <err>

Write Command

AT+GSN=<snt>

Response(s)

If <snt>=1

+CGSN: <sn>

If <snt>=2

+CGSN: <imeisv_number>

If <snt>=3

+CGSN: <SVN>

OK

ERROR

+CME ERROR: <err>

PIN → Last

- + -

Reference(s)

ITU-T V.250 [9]

Parameter Description

<sn>^(str)

International Mobile Equipment Identity (IMEI) identifying a mobile equipment used in the mobile network. IMEI is composed of Type Allocation Code (TAC) (8 digits), Serial Number (SNR) (6 digits) and the Check Digit (CD) (1 digit). For information on IMEI refer to 3GPP TS 23.003, subclause 6.2.1 and 3GPP TS 27.007 [39].

<snt>^(num)

Integer type indicating the serial number type that has been requested.

<imeisv_number>^(num)

IMEISV (International Mobile station Equipment Identity and Software Version number).

The 16 digits of IMEISV are composed of Type Allocation Code (TAC) (8 digits), Serial Number (SNR) (6 digits) and the software version (SVN) (2 digits). For information on IMEISV refer to 3GPP TS 23.003, subclause 6.2.2 and 3GPP TS 27.007 [39].

<SVN>^(num)

Current SVN which is a part of IMEISV; refer 3GPP TS 23.003, subclause 6.2.2 and 3GPP TS 27.007 [39]. This allows identifying different software versions of a given mobile.

5.7 AT+CIMI Request International Mobile Subscriber Identity (IMSI)

AT+CIMI delivers the International Mobile Subscriber Identity (IMSI). The IMSI permits the TE to identify the individual SIM attached to the UE.

Syntax

Test Command	
AT+CIMI=?	
Response(s)	
OK	
Exec Command	
AT+CIMI	
Response(s)	
<imsi>	
OK	
ERROR	
+CME ERROR: <err>	
PIN → Last	Reference(s)
+ + -	3GPP TS 27.007 [39]

Parameter Description

<imsi> ^(str)
International Mobile Subscriber Identity (string without quotes).

6. Security Commands

The AT Commands described in this chapter allow the external application to determine various security related settings.

6.1 AT+CPIN PIN Authentication

The [AT+CPIN](#) write command can be used to enter one of the passwords listed below. The read command checks whether or not the UE is waiting for a password, or which type of password is required.

Syntax

Test Command AT+CPIN=? Response(s) OK	
Read Command AT+CPIN? Response(s) +CPIN: <code> OK ERROR +CME ERROR: <err>	
Write Command AT+CPIN=<pin>[, <new pin>] Response(s) OK ERROR +CME ERROR: <err>	
PIN → Last - + -	Reference(s) 3GPP TS 27.007 [39]

Parameter Description

<pin> ^(str)	Password (string type), e.g. SIM PIN1. If the requested password was a PUK then <pin> must be followed by <new pin>.
<new pin> ^(str)	If the requested code was a PUK: specify a new password or restore the former disabled password.
<code> ^(text)	SIM PIN authentication READY PIN has already been entered. No further entry needed. SIM PIN ME is waiting for SIM PIN1.

6.1 AT+CPIN

SIM PUK	ME is waiting for SIM PUK1 if PIN1 was disabled after three failed attempts to enter PIN1.
SIM PIN2	ME is waiting for PIN2. This is only applicable when an attempt to access a PIN2 related feature was acknowledged with +CME ERROR: 17 ("SIM PIN2 required") In this case the read command AT+CPIN? also prompts for SIM PIN2.
SIM PUK2	ME is waiting for PUK2 to unblock a disabled PIN2. As above, this is only necessary when the preceding command was acknowledged with +CME ERROR: 18 ("SIM PUK2 required") and only if the read command AT+CPIN? also prompts for SIM PUK2.
PH-SIM PIN	ME is waiting for phone-to-SIM card password if "PS" lock is active and the client inserts other SIM card than the one used for the lock. ("PS" lock is also referred to as phone or antitheft lock).
PH-NET PIN	ME is waiting for network personalisation password
PH-NET PUK	ME is waiting for network personalisation unblocking password

Notes

- Successful PIN authentication only confirms that the entered PIN was recognized and correct. The output of the result code OK does not necessarily imply that the mobile is registered to the desired network. Typical example: PIN was entered and accepted with OK, but the ME fails to register to the network. This may be due to missing network coverage, denied network access with currently used SIM card, no valid roaming agreement between home network and currently available operators etc. ELS31-V offers various options to verify the present status of network registration: For example, the [AT+COPS](#) command indicates the currently used network. With [AT+CEREG](#) you can also check the current status and activate an unsolicited result code which appears whenever the status of the network registration changes (e.g. when the ME is powered up, or when the network cell changes).
- See [AT+CPWD](#) for information on passwords.
- See [AT+CLCK](#) for information on lock types.

6.2 AT+CPINR Remaining PIN Entries

The [AT+CPINR](#) execution command causes the UE to return the number of remaining PIN retries for the UE passwords with intermediate result codes "+CPINR" for standard PINs and "+CPINRE" for manufacturer set PINs.

Syntax

Test Command

```
AT+CPINR=?
```

Response(s)

```
OK
```

Exec Command

```
AT+CPINR
```

Response(s)

```
+CPINR: SIM PIN , <retries>, <default_retries>  
+CPINR: SIM PUK , <retries>, <default_retries>  
+CPINR: SIM PIN2 , <retries>, <default_retries>  
+CPINR: SIM PUK2 , <retries>, <default_retries>  
OK  
ERROR  
+CME ERROR: <err>
```

Write Command

For standard PINs:

```
AT+CPINR=<sel_code>
```

Response(s)

```
If <sel_code>= "SIM PIN":  
+CPINR: SIM PIN , <retries>, <default_retries>  
  
If <sel_code>= "SIM PUK":  
+CPINR: SIM PUK , <retries>, <default_retries>  
  
If <sel_code>= "SIM PUK2":  
+CPINR: SIM PUK2 , <retries>, <default_retries>  
  
If <sel_code>= "SIM PIN2":  
+CPINR: SIM PIN2 , <retries>, <default_retries>  
  
If <sel_code>= "SIM PUK2":  
+CPINR: SIM PUK2 , <retries>, <default_retries>  
OK  
ERROR  
+CME ERROR: <err>
```

Write Command

For passwords set by manufacturer:

```
AT+CPINR=<sel_code>
```

Response(s)

```
If <sel_code> related to manufacturer lock:  
+CPINRE: <ext_code>, <retries>, <default_retries>  
OK  
ERROR  
+CME ERROR: <err>
```

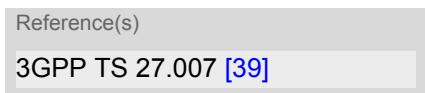
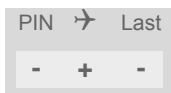

Parameter Description

`<code>`^(text)

Type of PIN. All values listed under the description of the [AT+CPIN](#) command, `<code>` parameter, except "READY".

`<retries>`^(num)

Number of remaining retries per PIN.

`<default_retries>`^(num)

Number of default/initial retries per PIN.

`<ext_code>`^(text)

Extended, manufacturer specific codes. If manufacturer lock(s) are set, remaining entries are indicated with intermediate result code "+CPINRE".

`<sel_code>`^(str)

Same values as for the `<code>` and `<ext_code>` parameters. These values are strings and indicated within double quotes.

Only "SIM PIN" and "SIM PUK" codes are supported. Wildcard matching by "*" is not supported.

6.3 AT+CLCK Facility lock

AT+CLCK can be used to lock, unlock or interrogate a network or UE *<facility>*. The command can be aborted when network facilities are being set or interrogated.

Syntax

<p>Test Command</p> <p>AT+CLCK=?</p> <p>Response(s)</p> <p>+CLCK: list of supported <i><facility></i>s</p> <p>OK</p>	
<p>Write Command</p> <p>AT+CLCK=<i><facility></i>, <i><mode></i>[, <i><password></i>]</p> <p>Response(s)</p> <p>if <i><mode></i> is not equal 2 and command successful:</p> <p>OK</p> <p>if <i><mode></i>= 2 and command successful:</p> <p>+CLCK: <i><status></i></p> <p>OK</p> <p>ERROR</p> <p>+CME ERROR: <i><err></i></p>	
<p>PIN → Last</p> <p>+ ± -</p>	<p>Reference(s)</p> <p>3GPP TS 27.007 [39], 3GPP TS 22.004 [18], 3GPP TS 22.088 [26], 3GPP TS 23.088, 3GPP TS 24.088</p>

Parameter Description

<i><facility></i> ^(str)	
"SC"	SIM (lock (U)SIM cards) (U)SIM requests password upon UE power-up and when this lock command is issued. <i><password></i> : SIM PIN1.
"PS"	PH SIM (lock PPhone to (U)SIM card). UE requests password when other than current (U)SIM card is inserted. <i><password></i> : PH-SIM PIN.
"FD"	SIM Fixed Dialing lock <i><password></i> : SIM PIN2. Note: In case of "FD, only <i><mode></i> 2 (Query status) is supported, <i><mode></i> 0 and 1 return "+CME ERROR".

Factory defined (U)SIM locks:

Typical examples of factory set (U)SIM locks are prepaid phones or network locks, used to restrict the operation of a mobile to a specific provider or operator. The client should be aware that each of these lock types can only be unlocked if the associated password is available. For example, a mobile can be locked to accept only (U)SIM cards from the respective provider, or even one single (U)SIM card. Once a different (U)SIM card is inserted the UE will prompt the client to enter a specific code. This is not the PUK of the (U)SIM card, but usually an 8-digit code which needs to be requested from the provider.

The locks can only be set by the manufacturer and need to be agreed upon between the parties concerned, e.g. provider, operator, distributor etc. on the one side and the manufacturer on the other side. For details contact your local dealer or Gemalto M2M GmbH.

<password> and instructions for unlocking must be obtained from the network provider.

“PN“ Network Personalisation

<mode>^(num)

0	Unlock
1	Lock
2	Query status

<status>^(num)

0	Lock is inactive
1	Lock is active

<password>^(str)

Password string used to lock and to unlock a <facility>. Length and authority for passwords depend on the <facility> in question and are therefore listed in the section on parameter <facility>. Passwords can be modified with AT+CPWD.

Examples

EXAMPLE 1

Lock (U)SIM card (<facility>= "SC")

AT+CLCK="SC",1,"9999"	The "SC" parameter enables or disables the SIM PIN authentication (PIN 1) when you power up the UE.
OK	(U)SIM card locked. As a result, SIM PIN 1 must be entered to enable UE to register to the network.

AT+CLCK="SC",0,"9999"	Unlocks SIM card.
OK	When powered up, UE registers to the network without requesting SIM PIN1. Note: Depending on the services offered by the provider, this feature is not supported by all SIM card types. If so, the command returns ERROR when you attempt to unlock the card.

To query the status of the SIM card lock:

AT+CLCK="SC",2	Query the status of SIM card lock.
+CLCK: 1	(U)SIM card is locked. SIM PIN1 must be entered to enable UE to register to the network.
OK	

EXAMPLE 2

Phone lock (<facility>="PS")

AT+CPIN?	Make sure that PIN1 authentication is valid.
OK	

To lock the UE to the currently inserted (U)SIM card, first specify a password for <facility> "PS":

AT+CPWD="PS",,"1234"	If "PS" lock has not been set before: enter new password.
OK	

Optionally, if "PS" password was defined before, change existing password:

AT+CPWD="PS","1234","3333"	To replace existing "PS" password: Enter old and new password.
OK	

Then, activate the Phone Lock:

```
AT+CLCK="PS",1,"3333"      Locks the mobile to the current SIM card.  
OK
```

To operate the mobile with the (U)SIM card for which "PS" lock was activated:

```
AT+CPIN?  
+CPIN: SIM PIN  
OK  
AT+CPIN="9999"  
OK                          No additional password is required for operation ((U)SIM recognized by  
                             mobile).
```

To operate the mobile with other (U)SIM card than the one used for the "PS" lock:
Enter SIM PIN of present card, followed by "PS" lock password.

```
AT+CPIN?  
+CPIN: SIM PIN  
OK  
AT+CPIN="1111"  
OK                          PIN authentication accepted.  
AT+CPIN?  
+CPIN: PH-SIM PIN          "PS" lock password is required.  
OK  
AT+CPIN="3333"  
OK                          "PS" Lock password has been accepted. UE is fully operational now.
```

To deactivate the Phone Lock:

```
AT+CLCK="PS",0,"3333"      Phone Lock password has to be provided again.  
OK                          Now the mobile can be used with any (U)SIM card, without the need of  
                             the phone lock password.
```

6.4 AT+CPWD Change Password

AT+CPWD allows to define a new password for a password protected `<facility>` lock function. Each password is a string of digits, the length of which varies with the associated `<facility>`. The test command returns a list of pairs which represent the available facilities and the maximum length of the associated password. See **AT+CLCK** for more information on the various lock features.

To delete a password use the following syntax: **AT+CPWD=<facility>,<old password>**.

Syntax

<p>Test Command</p> <p>AT+CPWD=?</p> <p>Response(s)</p> <p>+CPWD: list of supported (<code><facility></code>, <code><password length></code>)</p> <p>OK</p>	
<p>Write Command</p> <p>AT+CPWD=<code><facility></code>,<code><old password></code>[,<code><new password></code>]</p> <p>Response(s)</p> <p>New password has been registered for the facility lock function.</p> <p>OK</p> <p>If parameter <code><old password></code> was not correct:</p> <p>+CME ERROR: 16 (+CME ERROR: incorrect password)</p> <p>If the password for the selected <code><facility></code> has been invalidated due to too many failed attempts:</p> <p>+CME ERROR: ...</p> <p>If error is related to ME functionality:</p> <p>+CME ERROR: <code><err></code></p>	
<p>PIN → Last</p> <p>+ ± -</p>	<p>Reference(s)</p> <p>3GPP TS 27.007 [39]</p>

Parameter Description

<code><facility></code> ^(str)	
"SC"	SIM PIN. (U)SIM requests password upon ME power-up and when this lock command is issued. If incorrectly entered three times, the SIM PUK is required to perform authentication. Input of the SIM PUK password is possible only with AT command AT+CPIN . <code><password length></code> : 4 to 8 digits.
"PS"	Phone locked to (U)SIM card. ME requests password when other than current (U)SIM card is inserted. "PS" lock is frequently referred to as "phone lock", or "device lock".
"P2"	SIM PIN 2, e.g. required for authentication with facility lock "FD" (cf. AT+CLCK). If incorrectly entered three times, the SIM PUK 2 is required to perform authentication. Input of the SIM PUK 2 password is possible only with AT command AT+CPIN . <code><password length></code> : 4 to 8 digits.

Factory defined (U)SIM locks:

Typical examples of factory set (U)SIM locks are prepaid phones or network locks, used to restrict the operation of a mobile to a specific provider or operator. The client should be aware that each of these lock types can only be unlocked if the associated password is available. For example, a mobile can be locked to accept only (U)SIM cards from the respective provider, or even one single (U)SIM card. Once a different SIM card is inserted the ME will prompt the client to enter a specific code. This is not the PUK of the (U)SIM card, but usually an 8-digit

7. Call related Commands

The AT Commands described in this chapter are related to data connections.

7.1 ATH Disconnect existing connection

[ATH](#) disconnects any active PPP connection.

Syntax

Exec Command

ATH[<n>]

Response(s)

OK

PIN → Last

- - -

Reference(s)

ITU-T V.250 [9]

Parameter Description

<n>^(num)

[0]

Disconnect from command line and terminate connection.

7.2 ATO Switch from command mode to data mode / PPP online mode

[ATO](#) is the corresponding command to the `+++` escape sequence: If the UE is in command mode during a data connection [ATO](#) causes the UE to return to data mode.

Syntax

Exec Command	
ATO[<n>]	
Response(s)	
If connection is not successfully resumed: NO CARRIER or TA returns to data mode from command mode CONNECT	
PIN → Last	Reference(s)
- - -	ITU-T V.250 [9]

Parameter Description

<n> ^(num)	
[0]	Switch from command mode to data mode

7.3 +++ Switch from data mode or PPP online mode to command mode

The +++ escape sequence is only available during a packet switched connection. The +++ character sequence causes the ELS31-V to pause data mode and return to AT command mode. This allows to enter AT commands while maintaining the data connection to the remote device. The same task can be performed by toggling the DTR line if [AT&D](#) is set to 1. [ATO](#) is used to resume data or PPP online mode.

To prevent the +++ character sequence from being misinterpreted as data, it must be preceded and followed by a pause of at least 1000 ms. The +++ characters must be entered in quick succession, all within 1000 ms.

Syntax

Exec Command	
+++	
Response(s)	
OK	
PIN → Last	Reference(s)
- + -	ITU-T V.250 [9]

8. Network Service Commands

The AT Commands described in this chapter are related to various network services.

8.1 AT+COPN Read operator names

The [AT+COPN](#) command returns the list of operator names from the UE. Each operator code `<numericn>` that has an alphanumeric equivalent `<alphan>` in the UE memory is returned.

Syntax

Test Command	
AT+COPN=?	
Response(s)	
OK	
ERROR	
+CME ERROR: <code><err></code>	
Exec Command	
AT+COPN	
Response(s)	
+COPN: <code><numericn></code> , <code><alphan></code>	
[+COPN: ...]	
OK	
ERROR	
+CME ERROR: <code><err></code>	
PIN → Last	Reference(s)
- + -	3GPP TS 27.007 [39]

Parameter Description

<code><numericn></code> ^(str)
Operator in numeric format
<code><alphan></code> ^(str)
Operator in long alphanumeric format

8.2 AT+COPS Operator Selection

AT+COPS queries the present status of the ELS31-V's network registration and allows to determine whether automatic or manual network selection shall be used.

Three operator selection modes are available with **AT+COPS**:

- Automatic
ELS31-V searches for the home operator automatically. If successful the ELS31-V registers to the home network. If the home network is not found, ELS31-V goes on searching. If a permitted operator is found, ELS31-V registers to this operator.
If no operator is found the ELS31-V remains unregistered.
- Manual
Desired operator can be determined using the **AT+COPS** write command. If the operator is found, ELS31-V registers to it immediately. If the selected operator is forbidden, the ELS31-V remains unregistered.
- Manual/automatic
The UE first tries to find the operator determined via **AT+COPS** write command. If the UE fails to register to this operator, then it starts to select another (permitted) operator automatically.

The **AT+COPS** test command lists sets of five parameters, each representing an operator present in the network. A set consists of

- an integer indicating the availability of the operator,
- long alphanumeric format of the operator's name,
- short alphanumeric format of the operator's name,
- numeric format representation of the operator and
- an integer indicating the access technology of the operator.

Any of the parameters may be unavailable and will then be an empty field (,). The list of operators comes in the following order: Home network, networks referenced in SIM and other networks.

The operator list is followed by a list of the supported **<mode>**s and **<format>**s. These lists are delimited from the operator list by two commas.

The response to the **AT+COPS** test command is independent on the settings made with **<mode>** and **<rat>**. The **AT+COPS** test command will return a list of operators with the supported **<rat>**s.

The response to the **AT+COPS** read command depends on the registration status. If the UE is not registered, the read command returns only the current **<mode>**. If the UE is registered the response returns the currently selected operator, the currently set format and the currently used **<rat>**.

The **AT+COPS** write command forces an attempt to select and register to a network operator. If the selected operator is not available, no other operator will be selected (except **<mode>**=4). The selected operator name **<format>** will apply to further read commands, too.

Syntax

Test Command

```
AT+COPS=?
```

Response(s)

```
+COPS: [list of supported (<opStatus>, long alphanumeric <opName>, short alphanumeric <opName>, numeric <opName>, <rat>)s ], , (list of supported <mode>s), (list of supported <format>s)  
OK  
ERROR  
+CME ERROR:<err>
```

Read Command

```
AT+COPS?
```

Response(s)

```
+COPS: <mode>[, <format>, <opName>[, <rat>]]  
OK
```

Read Command	(Continued)
AT+COPS?	
Response(s)	
ERROR +CME ERROR: <err>	
Write Command	
AT+COPS=<mode>[, <format>[, <opName>][, <rat>]]	
Response(s)	
OK ERROR +CME ERROR: <err>	
PIN → Last	Reference(s)
± - -	3GPP TS 27.007 [39]

Parameter Description

<opStatus>^(num)

Operator Status

0	Unknown
1	Operator available
2	Current operator
3	Operator forbidden

<opName>^{(str)&(V)}

Operator Name

If test command: Operator name in long alphanumeric format, short alphanumeric format and numeric format.
If read command: Operator name as per <format>.
If write command: Operator name in numeric format.

<mode>^{(num)&(V)(NV)}

Only Parameter values 0 and 1 are stored in the non-volatile memory of the ELS31-V.

0 ^(D)	Automatic mode; <opName> field is ignored.
1	Manual operator selection The AT+COPS write command requires <opName> in numeric format, i.e. <format> shall be 2. When using this mode keep in mind that only the <mode> parameter is non-volatile, but not the selected <opName>. After restarting the UE the network will be selected according to the priority order specified in 3GPP TS 23.122: "Last Registered PLMN", "Home PLMN", "Preferred PLMN" (related (U)SIM elementary files are EF_LOCI, EF_IMSI, EF_PLMNwAct). The same priority order applies when swapping the (U)SIM during operation.
2	Manually deregister from network and remain unregistered until <mode>=0 or 1 or 4 is selected.
3	Set only <format> (for AT+COPS read command).
4	Manual / automatic selection; if manual selection fails, automatic mode (<mode>=0) is entered (<opName> field will be present).

`<rat>`^{(num)(&V)(NV)}

Radio Access Technology (RAT)

7 E-UTRAN

`<format>`^{(num)(&V)(&W)}

0^{(&F)(D)}

Long alphanumeric format of `<opName>`.

1

Short alphanumeric format of `<opName>`.

2

Numeric format of `<opName>`. This is the Location Area Identification (LAI) number, which consists of the 3-digit Mobile Country Code (MCC) plus the 2- or 3-digit Mobile Network Code (MNC).

Note

- `AT+COPS=?` shows PLMNs as available (`<opStatus>=1`) as long as a location update was not rejected and the PLMNs are not written to the forbidden PLMN list (SIM EF-FPLMN).

8.3 AT+CESQ Extended Signal Quality

The `AT+CESQ` command returns received signal quality parameters. If the current serving cell is not a GERAN cell, `<rxlev>` and `<ber>` are set to value 99. If the current serving cell is not a UTRA FDD or UTRA TDD cell, `<rscp>` is set to 255. If the current serving cell is not a UTRA FDD cell, `<ecno>` is set to 255. If the current serving cell is not an E-UTRA cell, `<rsrq>` and `<rsrp>` are set to 255.

Syntax

<p>Test Command</p> <p>AT+CESQ=?</p> <p>Response(s)</p> <p>+CESQ: (list of supported <code><rxlev></code>s), (list of supported <code><ber></code>s), (list of supported <code><rscp></code>s), (list of supported <code><ecno></code>s), (list of supported <code><rsrq></code>s), (list of supported <code><rsrp></code>s)</p> <p>OK</p>	
<p>Exec Command</p> <p>AT+CESQ</p> <p>Response(s)</p> <p>+CESQ: <code><rxlev></code>, <code><ber></code>, <code><rscp></code>, <code><ecno></code>, <code><rsrq></code>, <code><rsrp></code></p> <p>OK</p> <p>ERROR</p>	
<p>PIN → Last</p> <p>+ - -</p>	<p>Reference(s)</p> <p>3GPP TS 27.007 [39]</p>

Parameter Description

<code><rxlev></code> ^(num)	Received signal strength level (see 3GPP TS 45.008 [42] subclause 8.1.4). For 2G networks only
99	not known or not detectable
<code><ber></code> ^(num)	Channel bit error rate (in percent). For 2G networks only
99	not known or not detectable
<code><rscp></code> ^(num)	Received signal code power (see 3GPP TS 25.133 [37] subclauses 9.1.1.3 and 9.1.1.1.3) For 3G networks only
255	not known or not detectable
<code><ecno></code> ^(num)	Ratio of the received energy per PN chip to the total received power spectral density (see 3GPP TS 25.133 [37] subclause 9.1.2.3) For 3G networks only
255	not known or not detectable
<code><rsrq></code> ^(num)	Reference signal received quality (see 3GPP TS 36.133 [41] subclause 9.1.7). For 4G networks only
0	rsrq < -19.5 dB
1	-19.5 dB ≤ rsrq < -19 dB
2	-19 dB ≤ rsrq < -18.5 dB

...	
94	$-4 \text{ dB} \leq \text{rsrq} < -3.5 \text{ dB}$
95	$-3.5 \text{ dB} \leq \text{rsrq} < -3 \text{ dB}$
96	$-3 \text{ dB} \leq \text{rsrq}$
255	not known or not detectable

`<rsrp>(num)`

Reference signal received power (see 3GPP TS 36.133 [41] subclause 9.1.4). For 4G networks only

0	$\text{rsrp} < -140 \text{ dBm}$
1	$-140 \text{ dBm} \leq \text{rsrp} < -139 \text{ dBm}$
2	$-139 \text{ dBm} \leq \text{rsrp} < -138 \text{ dBm}$
...	
95	$-46 \text{ dBm} \leq \text{rsrp} < -45 \text{ dBm}$
96	$-45 \text{ dBm} \leq \text{rsrp} < -44 \text{ dBm}$
97	$-44 \text{ dBm} \leq \text{rsrp}$
255	not known or not detectable

8.4 AT+CPOL Preferred Operator List

AT+CPOL read command queries the list of the preferred operators.
AT+CPOL write command allows to edit the list of the preferred operators.
The response of AT+CPOL read command also depends on the setting of AT+CPLS.
If <index> is given but <operator> is left out, the entry is deleted.

Syntax

<p>Test Command</p> <p>AT+CPOL=?</p> <p>Response(s)</p> <p>+CPOL: (list of supported <index>s), (list of supported <format>s)</p> <p>OK</p> <p>ERROR</p> <p>+CME ERROR: <err></p>	
<p>Read Command</p> <p>AT+CPOL?</p> <p>Response(s)</p> <p>+CPOL: <index>, <format>, <operator>[, <gsm>, <gsm_compact>, <utran>, <e-utran>]</p> <p>+CPOL: ...</p> <p>OK</p> <p>ERROR</p> <p>+CME ERROR: <err></p>	
<p>Write Command</p> <p>AT+CPOL=[<index>][, <format>[[, <operator>][, <gsm>, <gsm_compact>, <utran>, <e-utran>]]]</p> <p>Response(s)</p> <p>OK</p> <p>ERROR</p> <p>+CME ERROR: <err></p>	
<p>PIN → Last</p> <p>+ + -</p>	<p>Reference(s)</p> <p>3GPP TS 27.007 [39]</p>

Parameter Description

<index>^(num)	
The order number of the operator in the SIM preferred operator list.	
<format>^(num)	
0	Long alphanumeric format <operator>
1	Short alphanumeric format <operator>
2	Numeric format <operator>
<operator>^(str)	
The operator in the format specified in <format>.	

<gsm>^(num)

0	AcT GSM disabled
1	AcT GSM enabled

<gsm_compact>^(num)

0	AcT GSM Compact disabled
---	--------------------------

<utran>^(num)

0	AcT UTRAN disabled
1	AcT UTRAN enabled

<e-utran>^(num)

0	AcT E-UTRAN disabled
1	AcT E-UTRAN enabled

Note

- The Access Technology selection parameters <gsm>, <gsm_compact>, <utran>, <e-utran> are required for SIM cards or UICCs containing PLMN selector with Access Technology.

8.5 AT+CPLS Select Preferred Operator List

AT+CPLS is used to select a preferred PLMN list defined in Elementary Files of the SIM card or active application of the (U)SIM. The setting takes effect for the **AT+CPOL** command.

Syntax

<p>Test Command</p> <pre>AT+CPLS=?</pre> <p>Response(s)</p> <pre>+CPLS: (list of (U)SIM supported <plmn-selector>s) OK</pre>	
<p>Read Command</p> <pre>AT+CPLS?</pre> <p>Response(s)</p> <pre>+CPLS: <plmn-selector> OK ERROR +CME ERROR: <err></pre>	
<p>Write Command</p> <pre>AT+CPLS=<plmn-selector></pre> <p>Response(s)</p> <pre>OK ERROR +CME ERROR: <err></pre>	
<p>PIN → Last</p> <pre>+ - -</pre>	<p>Reference(s)</p> <p>3GPP TS 27.007 [39]</p>

Parameter Description

<plmn-selector> ^(num)	Description
0 ^(P)	User controlled PLMN with EF _{PLMNwAcT} /EF _{PLMNsel} If <plmn-selector> is omitted from the write command, the default value 0 is used instead.
1	Operator controlled PLMN selector with EF _{OPLMNwAcT}
2	HPLMN selector with EF _{HPLMNwAcT}

8.6 AT+CTZR Time Zone Reporting

The [AT+CTZR](#) command enables and disables event reporting for changes of time zone and daylight saving time. If reporting is enabled the ELS31-V returns unsolicited result codes whenever the time zone changes.

Syntax

<p>Test Command</p> <pre>AT+CTZR=?</pre> <p>Response(s)</p> <pre>+CTZR: (list of supported <mode>s) OK</pre>	
<p>Read Command</p> <pre>AT+CTZR?</pre> <p>Response(s)</p> <pre>+CTZR: <mode> OK ERROR +CME ERROR: <err></pre>	
<p>Write Command</p> <pre>AT+CTZR=<mode></pre> <p>Response(s)</p> <pre>OK ERROR +CME ERROR: <err></pre>	
<p>PIN → Last</p> <p>- + -</p>	<p>Reference(s)</p> <p>3GPP TS 27.007 [39]</p>

Unsolicited Result Codes

URC 1

```
+CTZV: <timezone>
```

The URC indicates that the time zone has changed.

URC 2

```
+CTZE: <timezone>, <dst>[, <time>]
```

The URC provides information on daylight saving time.

Parameter Description

<mode>^(num)	
0 ^(P)	Disable event reporting by URCs
1	Enable time event reporting by "+CTZV"
2	Enable time event reporting by "+CTZE"
<timezone>^(num)	
Integer value indicating the time zone	

<time>^(str)

Time in format "yy/MM/dd,hh:mms", wherein characters indicates year, month, day, hour, minutes, seconds.

<dst>^(num)

Parameter indicates daylight saving time as follows:

0	No adjustment for daylight daving time
1	+1 hour adjustment for daylight saving time
2	+2 hour adjustment for daylight saving time

8.7 AT+CTZU Automatic Time Zone Update

The [AT+CTZU](#) command enables and disables automatic time zone update via NITZ. In addition, [AT+CTZR](#) can be used to activate indicators reporting time zone information change.

Syntax

Test Command	
AT+CTZU=?	
Response(s)	
+CTZU: (list of supported <mode>s)	
OK	
Read Command	
AT+CTZU?	
Response(s)	
+CTZU: <mode>	
OK	
ERROR	
+CME ERROR: <err>	
Write Command	
AT+CTZU=<mode>	
Response(s)	
OK	
ERROR	
+CME ERROR: <err>	
PIN → Last	Reference(s)
- + -	3GPP TS 27.007 [39]

Parameter Description

<mode> ^(num)	
0	Disable automatic time zone update via NITZ
1 ^(P)	Enable automatic time zone update via NITZ.

8.8 AT^SMONI Monitoring Serving Cell

The `AT^SMONI` command supplies information of the serving cell.

Syntax

Test Command

```
AT^SMONI=?
```

Response(s)

```
OK
```

Exec Command

```
AT^SMONI
```

Response(s)

See: Section 8.8.1, [AT^SMONI Responses](#)

```
OK
```

Write Command

```
AT^SMONI=255
```

Response(s)

See: Section 8.8.1, [AT^SMONI Responses](#)

```
OK
```

```
ERROR
```

```
+CME ERROR: <err>
```

PIN → Last

```
- - -
```

Notes

- The parameters LAC and cell are presented as hexadecimal digits, the remaining parameters are composed of decimal digits.
- If the BS supports frequency hopping during a connection, the dedicated channel (ARFCN) is not stable. This mode is indicated by `chann = 'h'`.
- The service state 'SEARCH' (Searching) could mean a PLMN search or a cell search. This can also happen for a short time when the UE is leaving connected mode.

8.8.1 AT^SMONI Responses

UE is not connected:

- UE is camping on a LTE (4G) cell:

Syntax:

```
^SMONI: ACT,EARFCN,Band,DL bandwidth,UL bandwidth,Mode,MCC,MNC,TAC,Global Cell ID,Physical Cell ID,Srxlev,RSRP,RSRQ,Conn_state
```

Example:

```
^SMONI: 4G,6300,20,10,10,FDD,262,02,BF75,0345103,350,33.00,-94.30,-7.10,NOCONN
```

- UE is searching and could not (yet) find a suitable LTE (4G) cell:

Syntax:

```
^SMONI: ACT,EARFCN,Band,DL bandwidth,UL bandwidth,Mode,MCC,MNC,TAC,Global Cell ID,Physical Cell ID,Srxlev,RSRP,RSRQ,Conn_state
```

Example:

```
^SMONI: 4G,,,,,,,,,,,,,SEARCH
```

- UE is camping on a LTE (4G) cell but not registered to the network (only emergency call allowed):

```
Syntax:
^SMONI: ACT,EARFCN,Band,DL bandwidth,UL bandwidth,Mode,MCC,MNC,TAC,Global Cell ID,Physical Cell ID,Srxlev,RSRP,RSRQ,Conn_state
Example:
^SMONI: 4G,6300,20,10,10,FDD,262,02,BF75,0345103,350,33.21,-94.30,-7.10,LIMSRV
```

UE is connected:

- LTE (4G) cell:

```
Syntax:
^SMONI: ACT,EARFCN,Band,DL bandwidth,UL bandwidth,Mode,MCC,MNC,TAC,Global Cell ID,Physical Cell ID,TX_power,RSRP,RSRQ,Conn_state
Example:
^SMONI: 4G,6300,20,10,10,FDD,262,02,BF75,0345103,350,90.00,-94.10,-7.00,CONN
```

Columns for LTE (4G) Serving Channel parameters:

Column	Description
ACT	Access Technology
EARFCN	E-UTRA Absolute Radio Frequency Channel Number
Band	E-UTRA frequency band (see 3GPP 36.101)
DL bandwidth	DL bandwidth
UL bandwidth	UL bandwidth
Mode	FDD or TDD
MCC	Mobile Country Code (first part of the PLMN code)
MNC	Mobile Network Code (second part of the PLMN code)
TAC	Tracking Area Code (see 3GPP 23.003 Section 19.4.2.3)
Global Cell ID	Global Cell ID
Physical Cell ID	Physical Cell ID
Srxlev	RX level value for base station selection in dB (see 3GPP 25.304)
RSRP	Reference Signal Received Power (see 3GPP 36.214 Section 5.1.1.)
RSRQ	Reference Signal Received Quality (see 3GPP 36.214 Section 5.1.2.)
TX power	Used Uplink Power
Conn_state	Connection state. Can be one of following: CONN, LIMSRV, NOCONN or SEARCH

8.8.2 Service states

Depending on the service state, an additional textual output is generated (refer also to the response examples):

- "SEARCH" (Searching) - The MS is searching, but could not (yet) find a suitable cell. This output appears after restart of the MS or after loss of coverage.
- "NOCONN" (No connection) - The MS is camping on a cell and registered to the network. The service state is 'idle', i.e. there is no connection established or a dedicated channel in use.
- "LIMSRV" (Limited Service) - The MS is camping on a cell but not registered to the network. Only emergency calls are allowed. The MS enters this state, for example, when
 - no SIM card is inserted, or PIN has not been given,

-
- neither Home PLMN nor any other allowed PLMN are found,
 - registration request was not answered or denied by the network (use [AT+CREG](#) to query the registration status),
 - authentication failed.

8.9 AT^SMONP Monitoring Neighbour Cells

The `AT^SMONP` supplies information of active cells and all neighbour cells. The active cell information will be delivered additively because an UE can be situated in Soft Handover or Softer Handover.

Syntax

Test Command

```
AT^SMONP=?
```

Response(s)

```
OK
```

Exec Command

```
AT^SMONP
```

Response(s)

See: Section 8.9.1, [AT^SMONP Responses](#)

```
OK
```

Write Command

```
AT^SMONP=255
```

Response(s)

See: Section 8.9.2, [AT^SMONP Enhanced Responses](#)

```
OK
```

```
ERROR
```

```
+CME ERROR: <err>
```

PIN → Last

```
- - -
```

Notes

- Due to the fact that not all necessary information of the neighbour cells can be decoded during a connection, there are several constraints to be considered:
 - Only neighbour cells that have already been visible in IDLE mode will be further updated, as long as they are still included in the list.
 - Though new neighbour cells can be added to the list (e.g. due to handover), their C1 and C2 parameters cannot be displayed until the connection is released. In this case "-" is presented for C1 and C2.
- The neighbour cells have the same PLMN as the serving cell. In case of searching for a network the serving cell can change and the UE shows different sets of neighbour cells depending on the PLMN of the serving cell.
- Parameters for which no values are available are shown as "-".
- If `AT^SMONP` or `AT^SMONP=255` is called while the UE is searching for a network, the command will return "+CME ERROR: operation not supported".

8.9.1 AT^SMONP Responses

Responses of `AT^SMONP` execute command:

- In case of a LTE (4G) serving cell:

Syntax:

4G:

```
EARFCN1, RSRQ1, RSRP1, Srxlev1, PCI1, RSSI1
```

```
EARFCN2, RSRQ2, RSRP2, Srxlev2, PCI2, RSSI2
```

```
...
```

```
EARFCNn, RSRQn, RSRPn, Srxlevn, PCIn, RSSIn
```

Example:

```
4G:
1830, -11.70, -91.50, 38, 368, -61.03
1830, -11.60, -93.40, 36, 262, -72.14
1830, -11.70, -95.20, 35, 329, -74.44
1830, -14.30, -95.10, 34, 261, -72.52
1830, -18.40, -105.80, 24, 248, -74.24
OK
```

Columns for LTE (4G) parameters:

Column	Description
EARFCN	E-UTRA Absolute Radio Frequency Channel Number
RSRQ	Reference Signal Received Quality as measured by L1 in dB (see ETSI TS 136 214 version 10.1.0 Section 5.1.3.)
RSRP	Reference Signal Received Power as measured by L1 in dBm (see ETSI TS 136 214 version 10.1.0 Section 5.1.1.)
Srxlev	RX level value for base station selection in dB (see 3GPP 25.304)
PCI	Physical Cell ID
RSSI	Received Signal Strength Indication as measured by L1 in dBm

8.9.2 AT^SMONP Enhanced Responses

Responses of write command `AT^SMONP=255`:

- In case of a 4G serving cell:

Syntax:

```
4G:
EARFCN1, RSRQ1, RSRP1, Srxlev1, PCI1, RSSI1, Cell ID1, MCC1, MNC1, TAC1
EARFCN2, RSRQ2, RSRP2, Srxlev2, PCI2, RSSI2, Cell ID2, MCC2, MNC2, TAC2
...
EARFCNn, RSRQn, RSRPn, Srxlevn, PCIn, RSSIn, Cell IDn, MCCn, MNCn, TACn
```

Example:

```
4G:
1830, -12.60, -91.40, 38, 368, -60.02, 368, 262, 03, C463
1830, -11.70, -93.20, 36, 262, -72.05, 368, 262, 03, C463
1830, -10.90, -93.30, 36, 329, -73.77, 368, 262, 03, C463
1830, -15.10, -96.50, 33, 261, -72.60, 368, 262, 03, C463
OK
```

Columns for LTE (4G) parameters:

Column	Description
EARFCN	E-UTRA Absolute Radio Frequency Channel Number
RSRQ	Reference Signal Received Quality as measured by L1 in dB (see ETSI TS 136 214 version 10.1.0 Section 5.1.3.)
RSRP	Reference Signal Received Power as measured by L1 in dBm (see ETSI TS 136 214 version 10.1.0 Section 5.1.1.)
Srxlev	RX level value for base station selection in dB (see 3GPP 25.304)
PCI	Physical Cell ID
RSSI	Received Signal Strength Indication as measured by L1 in dBm
Cell ID	LTE Serving cell ID
MCC	Mobile Country Code
MNC	Mobile Network Code
TAC	Tracking Area Code (see 3GPP 23.003 Section 19.4.2.3)

8.10 AT^SNMON Network Monitoring

The `AT^SNMON` command can be used to monitor various network information.

Syntax

<p>Test Command</p> <pre>AT^SNMON=?</pre> <p>Response(s)</p> <pre>^SNMON: "INS", (list of supported <action>s), (list of supported <rb>s) OK ERROR +CME ERROR: <err></pre>	<p>Write Command</p> <p>Start network scan. <action> shall be 2.</p> <pre>AT^SNMON="INS", <action></pre> <p>Response(s)</p> <pre>If <ratINS>= 7: ^SNMON: "INS", <action>, <rb>, <ratINS>, <cell_Id>, <tac>, <plmn>, <earfcn>, <pci>, <bandwidthDownload>, <bandwidthUpload>, <rsrp>, <rsrq> [^SNMON: ...] If no cell can be found for a specific band all values behind <rb> are omitted: ^SNMON: "INS", <action>, <rb> OK ERROR +CME ERROR: <err></pre>
<p>PIN → Last</p> <pre>- - -</pre>	<p>Reference(s)</p> <p>3GPP TS 45.008 [42]</p>

Parameter Description

<code><action></code> ^(num)	
This parameter determines the action to be taken for the monitoring command. In case of "INS" function, only 2 is supported.	
0	Reserved value
1	Reserved value
2	Query values
<code><rb></code> ^(num)	
Radio Band	
In the response of the read command this parameter indicates the radio band of the cell that was scanned.	
65536	LTE 1700 (B4)
33554432	LTE 700 (B13)
<code><ratINS></code> ^(num)	
Radio Access Technology for subcommand INS	
7	EUTRAN

<plmn>^(str)

PLMN code

<dbm>^(str)

Signal Strength in dBm

<cell_id>^(str)

Cell ID (28 bit for LTE)

<earfcn>^(num)

E-UTRA Absolute Radio Frequency Channel Number

<pci>^(num)

Physical Cell ID

<rsrp>^(num)

Reference Signal Received Power as measured by L1 in dBm (see ETSI TS 136 214 version 10.1.0 Section 5.1.1.)

<rsrq>^(num)

Reference Signal Received Quality as measured by L1 in dB (see ETSI TS 136 214 version 10.1.0 Section 5.1.3.)

<tac>^(num)

Tracking Area Code (see 3GPP 23.003 Section 19.4.2.3)

<bandwidthDownload>^(num)

Download bandwidth

<bandwidthUpload>^(num)

Upload bandwidth

Notes

- The `AT^SNMON="INS"` command can be used even if no SIM is present or no SIM-PIN was entered.
- The `AT^SNMON="INS"` command depends on the registration state. A complete network scan is only possible if the module is not registered. To perform a complete scan it is recommended to deregister manually from the network.
- The `AT^SNMON="INS"` command may be aborted internally by any other network related activity that interferes with the network scan.
- The time required for a network scan depends not only on the number of radio bands to be scanned, but also on ripple and existing ghost peaks on the scanned radio bands.

9. Internet Service Commands

ELS31-V has an embedded TCP/IP stack that is driven by AT commands and enables the host application to easily access the Internet. The advantage of this solution is that it eliminates the need for the application manufacturer to implement own TCP/IP and PPP stacks, thus minimizing cost and time to integrate Internet connectivity into a new or existing host application. This chapter is a reference guide to all the AT commands and responses defined for use with the TCP/IP stack.

The embedded TCP/IP stack provides the following services:

1. Socket Services:
 - TCP Client in Non-Transparent or Transparent Mode
 - UDP Client in Non-Transparent or Transparent Mode
 - Transparent TCP Listener
 - Standard TCP Listener in Non-Transparent or Transparent Mode
 - Non-Transparent UDP Endpoint
2. FTP Client
3. HTTP Client
4. SMTP Client

Step-by-step overview of how to configure and use TCP/IP communications with ELS31-V:

- Use `AT+CGDCONT` to create an Internet connection profile (= bearer). The PDP context IDs set with `<cid>` will later be used as "conId" parameter when creating a service profile with `AT^SISS`. Optionally, you can specify DNS preferences using `AT^SICS`. To activate or deactivate the bearer use the `AT^SICA` command.
 - Use `AT^SISS` to create service profile(s), each identified by the `<srvProfileId>`. The service profile specifies the type of Internet service to use, e.g., Socket, FTP, HTTP, SMTP.
 - Once the bearer has been established with `AT^SICA`, and the service profile is created with `AT^SISS`, an Internet session can be opened by entering the `AT^SISO` write command and the desired `<srvProfileId>`. A URC indicates how to proceed. The "`^SIS`" URC with `<urcCause>` "5" shows that an opened listener or endpoint is ready. The "`^SISW`" URC means that data can be sent. The "`^SISR`" URC means that received data are available for reading. If an error occurs the "`^SIS`" URC is delivered instead.
 - The next steps differ depending on the service type and the transfer mode (Non-Transparent or Transparent).
 - Once a service is opened, the `AT^SISI` command shall be used to monitor the progress of the session. The command reports the service state of the used service profile and indicates the number of bytes sent and received, and, in the case of sending, the number of bytes acknowledged or unacknowledged at TCP layer.
 - If an error occurs during a session you can enter the `AT^SISE` command and the `<srvProfileId>` to identify the reason. This is especially important in polling mode.
 - Finally, to close an opened service, enter the `AT^SISC` write command and the `<srvProfileId>`. Then you can deactivate the bearer using `AT^SICA`.
- `AT^SISH` disconnects a remote client from a Transparent TCP Listener without closing the listener (see also below).

Transparent Mode or Non-Transparent Mode:

- *Transparent Mode* is stream-oriented, i.e. a single data stream can be sent, and another single data stream can be received. Packetizing of data is done automatically by the embedded TCP/IP stack. Transparent Mode is activated with `AT^SIST` and then indicated by the "CONNECT" result code. The mode eliminates the need for `AT^SISW` and `AT^SISR` read and write sequences.
- *Non-Transparent Mode* is packet oriented, i.e. data is transferred in separate packets. Maximum packet size is 1500 bytes for TCP, 1460 bytes for UDP. To read and write data `AT^SISW` and `AT^SISR` sequences shall be used.
To send or receive more than 1500 bytes, the read or write action shall be repeated until the data transfer has completed. Each read or write action requires that the command response (of `AT^SISR` or `AT^SISW`) confirms that the service is ready to send or receive data. The read/write cycles can be controlled by URCs or polling. For details see below, section "URC mode and polling mode".

To end an upload data stream set the `<eodFlag>` in the last `AT^SISW` command.

- FTP, HTTP, SMTP and UDP Endpoint employ Non-Transparent Mode. TCP Client, UDP client and Standard TCP Listener can employ both modes, and may even mix both modes in the same connection.

Listener services:

A listener is waiting for incoming remote client requests. ELS31-V supports two listener types: Transparent TCP Listener and Standard TCP Listener.

After opening a listener with `AT^SISO` no `^SISW` URC appears. Instead, the `^SIS` URC with `<urcCause>` "5" shows that the opened listener is ready and starts listening. Additionally, the states can be verified with `AT^SISI` which shows state "4" (Up - listening).

An incoming remote client request is indicated by the `^SIS` URC. For details please refer to Section 9.14, [Internet Service URC ^SIS](#), especially parameters `<urcCause>` and `<urcInfoId>`.

• Transparent TCP Listener:

- The Transparent TCP Listener can accept 1 remote client. The connection to the remote client does not need an additional service profile, as it uses the Transparent TCP Listener instance.
- To define a listener service profile as Transparent TCP Listener the "etx" parameter is mandatory in the address. See `AT^SISS`.
- `AT^SISS` allows some specific options for the Transparent TCP Listener service, such as "autoconnect", "connecttimeout", "addrfilter";
- If autoconnect is enabled an incoming remote client is indicated by the `^SIS` URC with `<urcCause>` "3" (Transparent) and `<urcInfoId>` "1" (= autoconnect enabled). The request is automatically accepted. The Listener profile instantly changes to Server mode (`AT^SISO <socketState>` to 4 = SERVER) and opens transparent data mode (indicated by "CONNECT" result code).
- If autoconnect is disabled, the remote client connection request is indicated by the `^SIS` URC with `<urcCause>` "3" (Transparent) and `<urcInfoId>` "0" (= autoconnect disabled). The request can be accepted with `AT^SISO` or rejected with `AT^SISH`. In all cases the same `<srvProfileId>` shall be used. After accepting the client the Listener profile instantly changes to Server mode (`AT^SISO <socketState>` to 4 = SERVER).
If a remote client connection request is not accepted within the configured 'connecttimeout', it will be rejected automatically, and the URC `^SIS` is sent with `<urcCause>` set to '4'.
- As long as one remote client is connected all other remote client requests are rejected automatically without displaying the `^SIS` URC. The `<rejCounter>` in the response of the `AT^SISO` read command indicates such hidden rejects.
- `AT^SISH` disconnects a remote client, without closing the service, allowing the Transparent TCP Listener to wait for the next remote client.
`AT^SISC` both disconnects the remote client and shuts down the Transparent TCP Listener.
- An example can be found in Section 9.14, [Internet Service URC ^SIS](#) and Section 9.15.5, [Transparent TCP Listener: Accepting / Rejecting Incoming Remote Client](#)

• Standard TCP Listener:

- The Standard Listener can accept several remote clients. Each incoming remote client connection request is dynamically assigned to the next free service profile indicated as `<srvProfileId>` within the `^SIS` URC. `<urcCause>` in the `^SIS` URC equals "1" (Non-Transparent). The dynamically assigned profile acts as Server (`AT^SISO <socketState>` equals 4 = SERVER). Its `<srvProfileId>` shall be used to accept the remote client with `AT^SISO`, or to reject it with `AT^SISC`. The number of acceptable remote clients depends on the number of free service profiles.
- To transfer data it is possible to proceed with Transparent Mode using `AT^SIST`, or Non-Transparent Mode using `AT^SISR` and `AT^SISW` read / write sequences.
- An example can be found in Section 9.14, [Internet Service URC ^SIS](#) and Section 9.15.3, [Configuring Non-Transparent Listener](#)

Socket service used with UDP protocol

The significant differences between the TCP and UDP protocols imply that UDP sometimes requires particular procedures or even specific parameters. Details on how to handle UDP services can be found in extra notes or are included in the general parameter descriptions.

The ELS31-V offers two kinds of Socket service with UDP protocol.

- *UDP Client:* Intended for connections to a given remote host. In this case the IP address and the UDP port of the remote host are set as a fixed parameter in the service profile. The UDP Client can use Transparent Mode and Non-Transparent Mode.
- *Non-Transparent UDP Endpoint:* IP address and UDP port of the remote hosts are handled in each read (`AT^SISR`) and write (`AT^SISW`) request. This enables the host application to communicate with different remote hosts.
See example in Section 9.15.9, [UDP Scenario](#).

Secure connection (TLS)

All services except Listener services support server and client authentication for Transport Layer Security (TLS).

- To set TLS add "s" to the address type, such as socktcps, sockudps, ftps, https, smtps. For details see `AT^SISS <srvParmTag>` parameter "address".
- To create, load, delete and read customized TLS certificates use the commands `AT^SBNW` and `AT^SBNR`.
- The `AT^SISS` session profile parameter "secopt" specifies whether or not to check certificates received from the server against the local certificate store (if at least one local certificate is set).
- The `AT^SCFG` subcommand "Tcp/TLS/Version" specifies the security level.
- The used certificates can be shown in text format (issuer, serial, subject, signatureAlg, thumbprint). For this purpose it is recommended to enable the "+CIEV: "is_cert" URC, see `AT^SIND`.

URC mode or polling mode (for non-Transparent Mode only)

The ELS31-V offers two modes of controlling a Non-Transparent Mode session opened with `AT^SISO`. To select the mode use the `AT^SCFG` command, parameter "Tcp/WithURCs" (refer to `<tcpWithUrc>`).

- **URC mode (delivery default):**
The progress of a Non-Transparent Mode session is URC driven. The URCs notify the host whether data can be sent or received, whether data transfer has completed, whether the service can be closed or whether an error has occurred. This mechanism eliminates the need to poll the service until the necessary progress information is received.
To enable the URC mode select: `AT^SCFG="Tcp/WithURCs",on`.
- **Polling mode:**
In polling mode, the presentation of URCs related to the Internet Services is disabled. The host is responsible to retrieve all the status information needed for controlling the Internet session. This is done by polling, where the host application keeps sending the commands `AT^SISR`, `AT^SISW`, `AT^SISI`.
To enable the polling mode select: `AT^SCFG="Tcp/WithURCs",off`.
The disabled URCs are the following: "`^SISR`" URC, "`^SISW`" URC and "`^SIS`" URC for parameter `<urcCause>=0` (Internet service events), but not for all other `<urcCause>s` (needed for Listener or Endpoint and therefore always enabled).

Address notation

Server addresses shall be provided as IPv4 addresses in standard dot format, e.g. "192.168.1.2", or as IPv6 addresses in standard colon format enclosed in square brackets, e.g. "[FE80::2]", or as server address names resolvable by a DNS server.

Timeouts

Timeouts are not part of the Internet AT command functionality implemented in ELS31-V and, if desired, are the responsibility of the host application. It is recommended that the host application validates URCs and AT command responses and reacts adequately, for example by sending a close message or starting a timer.

Using the DCD line to detect the connection status of Internet services

With `AT&C` you can configure the DCD line of the used serial interface to indicate whether an Internet service is

active. For Socket, HTTP the states "Up" or "Connecting" are indicated, for FTP and transparent TCP only the state "Up", for the Transparent TCP Listener service the states "Up", "Alerting", "Connected" and "Released".

9.1 AT^SICA Internet Connection Activate or Deactivate

The [AT^SICA](#) write command can be used to activate or deactivate an Internet service connection using a PDP context defined with [AT+CGDCONT](#). To track activation errors the command [AT+CEER](#) should be used.

The [AT^SICA](#) read command shows whether a connection for Internet services is active and which PDP context is used for it. If no connection is active, then the read command just returns OK.

Syntax

Test Command

```
AT^SICA=?
```

Response(s)

```
^SICA: (list of supported <state>s), (list of supported <cid>s)
```

```
OK
```

```
ERROR
```

```
+CME ERROR: <err>
```

Read Command

```
AT^SICA?
```

Response(s)

```
[^SICA: <cid>, <state>]
```

```
[^SICA: ...]
```

```
OK
```

```
ERROR
```

```
+CME ERROR: <err>
```

Write Command

```
AT^SICA=<state>, <cid>
```

Response(s)

```
OK
```

```
ERROR
```

```
+CME ERROR: <err>
```

PIN → Last

```
+ - -
```

Parameter Description

<state>^(num)

0	Deactivate(d)
---	---------------

1	Activate(d)
---	-------------

<cid>^(num)

Parameter specifies a particular PDP context definition (see [AT+CGDCONT](#) parameter <cid>).

9.2 AT^SICS Internet Connection Settings

AT^SICS serves to specify additional settings for Internet connection specified with the AT+CGDCONT command. Currently only setup and query of DNS server addresses is supported.

Table 9.1: Applicability of AT^SICS <conParmTag> values

<conParmTag>	Mandatory or optional
"dns1"	optional
"dns2"	optional
"ipv6dns1"	optional
"ipv6dns2"	optional

Syntax

```

Test Command
AT^SICS=?
Response(s)
OK

Read Command
AT^SICS?
Response(s)
^SICS: <conProfileId>, <conParmTag>, <conParmValue>
[^SICS: ...]
OK

Write Command
AT^SICS=<conProfileId>[, <conParmTag>, <conParmValue>]
Response(s)
OK
ERROR
+CME ERROR: <err>

PIN → Last
- + -
    
```

Parameter Description

<conProfileId>^{(num)(NV)}
 Internet connection profile as specified with AT+CGDCONT parameter <cid>. Invoking command only with this parameter will delete related DNS server address.

<conParmTag>^{(str)(NV)}
 Internet connection parameter.
 "dns1" Primary DNS server address (IP address in dotted-four-byte format). This value determines whether to use the DNS server addresses dynamically assigned by the network or a specific DNS server address given by the user. "dns1" = "0.0.0.0" (default) means that the connection profile uses dynamic DNS assignment. Any other address means that the Primary DNS is manually set. The default value applies automatically if no other address is set. Note that the

AT^SICS read command only returns a manually configured IP address, while the value "0.0.0.0" is not indicated at all, no matter whether assumed by default or explicitly specified.
See also note below.

"dns2"
Secondary DNS server address (IP address in dotted-four-byte format).
If "dns1" = "0.0.0.0" this setting will be ignored. Otherwise this value can be used to manually configure an alternate server for the DNS1.
If "dns1" is not equal "0.0.0.0" and no "dns2" address is given, then "dns2"="0.0.0.0" will be assumed automatically. The **AT^SICS** read command only returns a manually configured IP address, while the value "0.0.0.0" is not indicated at all, no matter whether assumed by default or explicitly specified.

"ipv6dns1"
Primary IPV6 DNS server address (IP address Each group is written as 4 hexadecimal digits and the groups are separated by colons (:). The whole address is encapsulated by brackets ([]).
This value determines whether to use the DNS server addresses dynamically assigned by the network or a specific DNS server address given by the user.
"ipv6dns1" = "" (default) means that the connection profile uses dynamic DNS assignment. Any other address means that the Primary DNS is manually set. The default value applies automatically if no other address is set. Note that the **AT^SICS** read command only returns a manually configured IP v6 address, while the value "" is not indicated at all, no matter whether assumed by default or explicitly specified.
See also note below.

"ipv6dns2"
Secondary IPV6 DNS server address (IP address Each group is written as 4 hexadecimal digits and the groups are separated by colons (:). The whole address is encapsulated by brackets ([]).
"ipv6dns2" = "" (default) means that the connection profile uses dynamic DNS assignment. Any other address means that the secondary DNS is manually set.
The default value applies automatically if no other address is set. Note that the **AT^SICS** read command only returns a manually configured IP v6 address, while the value "" is not indicated at all, no matter whether assumed by default or explicitly specified.

<conParmValue>^{(str)(NV)}

Parameter value; type and supported content depend on related <conParmTag>.

Note

- If a network does not support or is not correctly configured for automatic DNS address assignment the TCP/IP stack cannot resolve fully qualified domain names. In this case, a warning message will be returned when trying to open an Internet service configured for automatic DNS address assignment.

9.3 AT^SIPS Internet Profile Storage

AT^SIPS saves and loads the settings of the Internet connection and service profiles in the non-volatile memory. AT^SIPS can also be used to reset the settings to their default values without saving.

Syntax

```

Test Command
AT^SIPS=?
Response(s)
^SIPS:(list of supported <type>s), (list of supported <action>s), (list of supported <ProfileId>s)
OK

Write Command
AT^SIPS=<type>, <action>[, <ProfileId>]
Response(s)
OK
ERROR
+CME ERROR: <err>

PIN → Last
- + -
    
```

Parameter Description

<type>^(str)

Internet profile storage type parameter.

- “service” Handle AT^SISS parameter set.
- “all” Handle AT^SICS parameters AT^SISS parameters listed above.

<action>^(str)

Internet profile storage action parameter

- “reset” Reset current profile(s) for given <type> to default settings without saving. If <ProfileId> is given only specific profile will be reset. Only the connections which are in "Down" status and the services which are in "Allocated" status could be affected.
- “save” Stores current profile(s) for given <type>. If <ProfileId> is given only specific profile will be stored.
- “load” Loads current profile(s) for given <type>. If <ProfileId> is given only specific profile will be loaded.

<ProfileId>^(num)

Internet connection or service profile storage identifier

- 0...9 In case of connection profile, max = 5, please see <conProfileId>. In case of a service profile, max = 9, please see <srvProfileId>.
- If parameter is omitted, AT^SIPS applies to all possible profile identifiers of used <type>.

9.4 AT^SISS Internet Service Setup Profile

AT^SISS specifies the Internet service profiles needed to control data connections by using AT^SICA, AT^SISO, AT^SISC, AT^SISR, AT^SISW, AT^SIST and AT^SISE.

The AT^SISS read command requests the current settings of all Internet service profiles. One line is issued for every possible parameter of a given <srvParmTag> "srvType" value.

The AT^SISS write command specifies the parameters for a service profile identified by <srvProfileId>. At first the type of Internet service needs to be selected via <srvParmTag> value "srvType". This determines the applicability of all other <srvParmTag> values related to this "srvType" and, partially, sets their defaults. Changing the <srvParmTag> "srvType" of an existing service profile will reset all <srvParmTag> values.

To change the settings the write command needs to be executed for each single <srvParmTag>. All profile parameters set with AT^SISS are volatile. mandatory (= m) or optional (= o).

Table 9.2: Applicability of AT^SISS <srvParmTag> values

<srvParmTag>	Socket	FTP	HTTP	SMTP
SrvType	m	m	m	m
conId	m	m	m	m
address	m	m	m	m
tcpMR	o	o	o	o
tcpOT	o	o	o	o
cmd		m	m	o
files		o	o	o
ftpath		o		
smFrom				m
smRcpt				m
smCC				o
smSubj				m
smMsg				o
smAuth				m
hcContent			o	
hcContLen			m	
hcUserAgent			o	
hcProp			o	
user		m	o	m
passwd		m	o	m
alphabet	o	o	o	o
ipVer	o	o	o	o
secopt	o	o	o	o

Syntax

<p>Test Command</p> <pre>AT^SISS=?</pre> <p>Response(s)</p> <pre>OK</pre>
<p>Read Command</p> <pre>AT^SISS?</pre> <p>Response(s)</p> <pre>^SISS: <srvProfileId>, <srvParmTag>, <srvParmValue> [^SISS: ...] OK ERROR +CME ERROR: <err></pre>
<p>Write Command</p> <pre>AT^SISS=<srvProfileId>, <srvParmTag>, <srvParmValue></pre> <p>Response(s)</p> <pre>OK ERROR +CME ERROR: <err></pre>
<p>PIN → Last</p> <pre>- + -</pre>

Parameter Description

`<srvProfileId>(num)`

Internet service profile identifier.

The `<srvProfileId>` is used to reference all parameters related to the same service profile. Furthermore, when using the AT commands `AT^SISO`, `AT^SISR`, `AT^SISW`, `AT^SIST`, `AT^SISH` and `AT^SISC` the `<srvProfileId>` is needed to select a specific service profile.

0...9

`<srvParmTag>(u)`

Internet service profile parameter.

srvType	Type of Internet service to be configured with consecutive usage of <code>AT^SISS</code> . For supported values of <code><srvParmValue></code> refer to <code><srvParmValue-srv-Type></code> .
alphabet	Selects the character set for input and output of string parameters within a profile. The selected value is bound to the specific profile. This means that different profiles may use different alphabets. Unlike other parameters the alphabet can be changed no matter whether the <code><srvParmTag></code> value "srvType" has been set. For supported values of <code><srvParmValue></code> refer to <code><srvParmValue-alphabet></code> .
user	User name string for FTP, HTTP, SMTP authentication. Parameter is optional: The user name can be set by <code><srvParmTag></code> parameter "user" or as part of "address" parameter. For HTTP only simple authentication is supported. Length: 32 octects

passwd	<p>Password string for FTP, HTTP, SMTP authentication. Parameter is optional: The password can be set by <code><srvParmTag></code> parameter "password" or as part of "address" parameter. Length: 32 octets</p>
conld	<p>Internet connection profile as defined with <code>AT+CGDCONT</code>. The value is one of the PDP context IDs set with parameter <code><cid></code>.</p>
address	<p>String value containing the URL for the specific service:</p> <p>1. Socket Service URLs:</p> <ul style="list-style-type: none"> - TCP Client URL: "socktcp[s]://<host>:<remotePort>[;etx[=<etx-Char>][;timer=<value>][;bufsize=<value>]][;keepidle=<value>][;keepcnt=<value>][;keepintvl=<value>]" - UDP Client URL: "sockudp[s]://<host>:<remotePort>[;etx[=<etx-Char>][;timer=<value>][;bufsize=<value>]][;port=<localPort>]" - UDP Endpoint URL: "sockudp://:<localPort>" - TCP server URL: "socktcp://listener:<localPort>;keepidle=<value>][;keepcnt=<value>][;keepintvl=<value>]" - Transparent TCP Listener URL: "socktcp://listener:<localPort>;etx[=<etxChar>][;timer=<value>][;autoconnect='0 1']][;connecttimeout=<value>][;keepidle=<value>][;keepcnt=<value>][;keepintvl=<value>][;addrfilter=<filter>]" <p>Socket service URL parameters:</p> <ul style="list-style-type: none"> - <host>: IPv4 address in standard dot format, e.g. "192.168.1.2", or IPv6 address in standard colon format enclosed in square brackets, e.g. "[FE80::2]". - <remotePort>: 1 ... 2¹⁶-1 for the remote port number. - <localPort>: 1 ... 2¹⁶-1 for the local port number. - "etx": This parameter allows a socket service to use Transparent Mode. For the Transparent Listener "etx" is mandatory. For the Client services "etx" is optional, but required for using the Transparent Mode parameters "etxChar" and "timer". Please note that even though "etx" is set in a service profile, data transfer can be performed by a mixing Transparent Mode (<code>AT^SIST</code>) and Non-Transparent Mode (<code>AT^SISW</code> / <code>AT^SISR</code> cycles) in the same connection. This applies both to the Transparent Listener and to Client services. - "<etxChar>": Specifies the character used to change from Transparent Mode to AT Command Mode. range: 1...15,17...255 (16 is not allowed because it is used as DLE (0x10)) If parameter is not set no escaping is configured, thus requiring either <code>+++</code> or DTR ON-OFF transition for changing to AT command mode. If value is set, the transmitted bytes are parsed for the DLE (0x10) character followed by the specified <code><etxChar></code> value. If both characters are found the service returns to AT command mode without transmitting these two bytes (same as <code>+++</code>). If you wish to send DLE characters as normal text string within your payload data the characters shall be doubled (DLE DLE). - "bufsize": For Transparent Mode only: specifies maximum packet size for sending data with <code>AT^SIST</code>. range: 1..1460

- "timer": The parameter configures the Nagle algorithm, which is used in transparent access mode.
range: 0, 20...[100]...500 milliseconds in steps of 20
Value 0 disables the Nagle algorithm.
- "keepidle": specifies the TCP parameter TCP_KEEPIDLE (see RFC1122, Section 4.2.3.6; not for Transparent UDP client)
range: 1...65535 seconds; disabled if no value set (default).
- "keepcnt": specifies the TCP parameter TCP_KEEPCNT (see RFC1122, Section 4.2.3.6; not for Transparent UDP client); ignored if option "keepidle" is not set
range: 1...[9]...127
- "keepintvl": specifies the TCP parameter TCP_KEEPINTVL (see RFC1122, Section 4.2.3.6; not for Transparent UDP client); ignored if option "keepidle" is not set
range: 1...[75]...255 seconds
- "autoconnect" (for Transparent TCP Listener service only):
0 ... disabled (default)
1 ... automatically accept incoming client connects
- "connecttimeout": specifies the time after which incoming client connects are rejected automatically (for Transparent TCP Listener service only)
range: 1...[30]...180 seconds
- "addrfilter": This option allows to filter incoming client connects based on the IP address of the client (for Transparent TCP Listener service only). It is possible to specify a maximum of 3 filters separated by commas. If the IP address of any incoming client connect does not match any of the specified filters, then the connect is rejected automatically. If the option is not specified, then all client connects are allowed.
In IPv4: Each filter is specified as 4 numbers separated by dots ("In IPv6: Each filter is specified by up to 8 bytes separated by colons ("Examples: *:5678:9abc:def0:1234:5678:9ABC:D*F0
1234::
::1**4
1*34:***3456

2. FTP Client URL

"ftp[s]://[<user>:<passwd>@]<host>[:<port>][/<path>]"

"ftp://": The default TCP port 21 for ftp server is used.

"ftps://": The default SSL port 990 for secure ftp server is used.

<host>: element can be an IPv4 address, or an IPv6 address enclosed in square brackets, or a DNS FQDN string.

<port>: element can be set optional and replace the default port.

<user>: username for authentication, 32 octets. Can be set as part of "address" or separately by <srvParmTag> parameter "user".

<passwd>: password for authentication, 32 octets. Can be set as part of "address" or separately by <srvParmTag> parameter "passwd".

<path>: path of file or directory.

3. HTTP Client URL

Length: 6...255

"http[s]://[<user>:<passwd>@]<server>[:<port>/<path>]"

<server>: element can be an FQDN, or an IPv4 address, or an IPv6 address enclosed in square brackets.

<path>: path of file or directory.

	<p><port>: If parameter is omitted the service connects to HTTP default port 80. <user>: username for authentication, 32 octets. <passwd>: password for authentication, 32 octets. "https://": Used for SSL connection. Refer to "IETF-RFC 2616".</p>
	<p>4. SMTP Client URL "smtp[s]://[<user>:<passwd>@]<host>[:<Port>]" "smtp://": The default TCP port 25 for smtp server is used. "smtps://": The default SSL port 465 for secure smtp server is used. <host>: element can be an IPv4 address, or an IPv6 address enclosed in square brackets, or a DNS FQDN string. <port>: element can be set optional and replace the default port. <user>: username for authentication, 32 octets. Can be set as part of "address" or separately by <srvParmTag> parameter "user". <passwd> is for authentication, 32 octets. Can be set as part of "address" or separately by <srvParmTag> parameter "passwd".</p>
cmd	<p>1. HTTP service</p> <ul style="list-style-type: none"> - "0" or "get": Send HTTP GET request to server - "1" or "post": Send HTTP POST request to server - "2" or "head": Send HTTP HEAD request to server <p>2. FTP service</p> <ul style="list-style-type: none"> - get [<OffsetString>]: get a single file from FTP server. - put [<OffsetString>]: create and write a single file to FTP server using AT^SISSW. - dir: List the directory on the FTP server and show file size. - list: List the directory on the FTP server without showing file size. - size: Request the size of the file element on the FTP server. The size result is output as "^SIS" URC. - del: Delete a file specified with <srvParmTag> parameter "files" on FTP server . - append: Append data to existing file on FTP server - unique: Selects the FTP Store Unique command to create a file name unique to the current directory. If the file name is assigned by the server then the "^SIS" URC will appear, indicating <urcInfoId> 2100 and the file name. <p><OffsetString> is an optional parameter for "get" and "put". It allows resuming a broken uplink or downlink transfer to resend data. The <OffsetString> value specifies the offset in number of octets to start the transfer from. Maximum length is 16 digits. For "get" the <OffsetString> value must be calculated from the <urcInfoId> 2100 of the "^SIS" URC requested before by using "size".</p>
	<p>3. SMTP service</p> <ul style="list-style-type: none"> - at: send attachment(s) listed in the <srvParmTag> parameter "files". Max. 5 files are allowed. The content of the attachment(s) should be provided using AT^SISSW after the service was opened with AT^SISO.
ftpath	<p>Specifies the path of the remote FTP server after login. If no path is set the default path will be used.</p>
files	<p>Name of a file for upload from the AT command interface to a server, or download from a server to the AT command interface if the "cmd" parameter is given</p> <ul style="list-style-type: none"> - with "get" or "post" in case of HTTP, - with "get", "put" or "del" in case of FTP, - with "at" in case of SMTP. <p>In case of SMTP max. 5 files can be handled, each separated by comma. In case of FTP and HTTP only a single file can be handled.</p>

hcContent	<p>HTTP "POST": Variable mode. Optional parameter if HTTP "post" is set with <code><srvParmTag></code> parameter "cmd". Length: 0...255 Can be used to transfer a small amount of data. The content of this string will only be sent if "hcContLen" = 0. To transmit a larger amount of data "hcContLen" must be set to a non-zero value. In this case the "hcContent" string will be ignored, and data transmission from the client to the server is done with <code>AT^SISW</code>. Usage example: AT^SISS=x,cmd,"POST"</p> <p>AT^SISS=x,hcContent,"This text will be sent to the server now response OK" OK</p> <p>AT^SISS=x,hcContLen,0</p> <p>AT^SISO=x OK</p> <p>^SIS: x,0,2200,"Http connect 10.42.228.61:80" ^SISW: x,2</p>
hcContLen	<p>HTTP "POST": Fixed mode. Mandatory parameter if HTTP "post" is set with <code><srvParmTag></code> parameter "cmd". Length: 0...2³¹-1 The value of this parameter indicates the amount of bytes of data to be transmitted with Http POST. If "hcContLen" = 0 then the data given in the "hcContent" string will be posted without <code>AT^SISW</code> required. If "hcContLen" > 0 then <code>AT^SISW</code> command and "<code>^SISW: x, 1</code>" sequences will be used to send data from the client to the server. In this case "hcContent" parameter will be ignored. Usage example, send 200 bytes: AT^SISS=x,cmd,"POST"</p> <p>AT^SISS=x,hcContLen,200</p> <p>AT^SISO=x OK</p> <p>^SIS: x,0,2200,"Http connect 10.42.228.61:80" ^SIS: x,0,2200,"POST Bytes: 200" ^SISW: x,1</p> <p>AT^SISW=x,200 ### 200 bytes of data ###</p>
hcUserAgent	<p>The user agent string must be set by the application to identify the mobile. Usually operation system and software version info is set with this browser identifier. Length: 0...63</p>
hcProp	<p>Parameter for several HTTP settings. Length: 0...127 The general format is 'key': <space> 'value' Multiple settings can be given separated by "\0d\0a" sequences within the string, do not put them at the end. Possible 'key' values are defined at HTTP/1.1 Standard RFC 2616.</p>

smFrom	Email sender address, i.e. "MAIL FROM" address (string). Length: 6...254 A valid address parameter consists of local part and domain name delimited by a '@' character, e.g. "john.smith@somedomain.de".
smRcpt	Recipient address of the email, i.e. "RCPT TO" address (string). Length: 6...254 If multiple recipient addresses are to be supplied the comma character is used as delimiter to separate individual address values, e.g. "john.smith@somedomain.de,tom.meier@somedomain.de". Some mail servers do not accept recipient addresses without brackets <>. It is recommended to use the "RCPT TO" variable with brackets.
smCC	CC recipient address of the email (string). Length: 6...254 If multiple CC recipient addresses are to be supplied the comma character is used as delimiter to separate individual address values, e.g. "john.smith@somedomain.de,tom.meier@somedomain.de".
smSubj	Subject content of the email (string). Length: 0...254 If no subject is supplied the email will be sent with an empty subject.
smAuth	SMTP authentication control flag (string). If "smAuth" = "0" or "none": No authentication (for test environment only, not applicable to real network) If "smAuth" = "1" or "plain" (default): Authentication with PLAIN authentication If "smAuth" = "2" or "login": Authentication with LOGIN authentication If "smAuth" = "3" or "cram": Authentication with CRAM authentication
smMsg	SMTP message body. If no attachment is defined this is only the content of the email. Length: 0...254
tcpMR	Parameter can be used to overwrite the global AT^SCFG parameter "Tcp/MaxRetransmissions" <tcpMr> for a specific Internet Service connection profile. If the parameter is not specified the value specified with AT^SCFG will be used. Supported values <srvParmValue> for this parameter are the same as described for <tcpMr>. Setting is not relevant for Internet Service "Socket" with type "UDP".
tcpOT	Parameter can be used to overwrite the global AT^SCFG parameter "Tcp/OverallTimeout" <tcpOt> for a specific Internet Service connection profile. If the parameter is not specified the value specified with AT^SCFG will be used. Supported values <srvParmValue> for this parameter are the same as described for <tcpOt>. Setting is not relevant for Internet Service "Socket" with type "UDP".
ipVer	Used IP Protocol version: This parameter limits the IP Protocol version for the Internet service when the PDP context defined with AT+CGDCONT supports IPv4 and IPv6. 4 Values 4 (default) or 6 can be used for the following situations only: 6 An IPv4v6 PDP context is employed, and this context provides both IPv4 and IPv6 interfaces, and - either the service acts as a listener, - or the client address is a hostname, and the DNS server provides both IPV4 and IPV6 addresses. In such case value 4 allows IPv4 addresses only, and value 6 allows IPv6 addresses only.

10 Value 10 can be used for TCP listener and UDP endpoint only. It is possible to use this value for every PDP context type. If an IPv4v6 PDP context is used, and this context provides both IPv4 and IPv6 interfaces, then it is possible to connect to an IPv4 client and an IPv6 client at the same time. Addresses are always shown in IPv6 format. For IPv4 connections, IPv4-mapped IPv6 address notation is used, i.e. [::ffff:10.66.90.170]. For AT^SISO?, TCP listener and UDP endpoint show "[:]" as local address. Please use [AT+CGPADDR](#) to read local address information in this case.

secopt Security Option of IP service. Values:
 1 (default) Check received certificates from server against local store, if local store has at least one certificate.
 0 Do not check received certificates from server against the local store.
 NOTE: Local store is created with AT^SBNW,is_cert.

`<srvParmValue>(str)(+CSCS)`

Parameter value; type and supported content depend on related `<srvParmTag>`.

`<srvParmValue-srvType>(str)`

Supported Internet service type values in `<srvParmValue>` for `<srvParmTag>` value "srvType". Before changing the "srvType" of an existing service profile be sure that the profile is closed. To verify the connection state of the service profile enter the read command AT^SISI. Only when `<srvState>`=2 is returned for this specific service profile you can change its service type.

"Socket"	ELS31-V acting as client or server (listener) for TCP or UDP. "etx" subparameter in URL configures Transparent mode for Socket service.
"Ftp"	ELS31-V acting as FTP client.
"Http"	ELS31-V acting as HTTP client.
"Smtpt"	ELS31-V acting as SMTP client.
"none"	Reset Internet service profile settings. Operation is not allowed if profile is in use, i.e. it was activated via AT^SISO.

`<srvParmValue-alphabet>(str)`

Supported string parameter character set selections in `<srvParmValue>` for `<srvParmTag>` value "alphabet".

["0"]	Applicable character set is determined by current setting of AT+CSCS.
"1"	International Reference Alphabet (IRA, seven bit ASCII).

Notes

- String parameters are truncated if greater than the maximum length specified above.
- For correct input of the @ character in address parameters please refer to Section 1.6, [Supported character sets](#).

9.5 AT^SISI Internet Service Information

AT^SISI serves to monitor the status of Internet service profiles defined with AT^SISS.

The AT^SISI read command requests the current status of all defined Internet service profiles.

The AT^SISI write command requests the status of the specified Internet service profile. If the specified service profile is not defined yet, "+CME ERROR" is returned.

Syntax

Test Command

```
AT^SISI=?
```

Response(s)

```
[^SISI: (list of defined <srvProfileId>s)]  
OK
```

Read Command

```
AT^SISI?
```

Response(s)

If response is related to service profile(s) created / opened on this interface:

```
[^SISI: <srvProfileId>, <srvState>, <rxCount>, <txCount>, <ackData>, <unackData>]  
[^SISI: ...]
```

If response is related to service profile(s) created / opened on other interface(s):

```
[^SISI: <srvProfileId>, <srvParmTag>value "srvType"]  
[^SISI: ...]
```

OK

ERROR

Write Command

```
AT^SISI=<srvProfileId>
```

Response(s)

```
^SISI: <srvProfileId>, <srvState>, <rxCount>, <txCount>, <ackData>, <unackData>
```

OK

ERROR

```
+CME ERROR: <err>
```

PIN → Last

- + -

Parameter Description

`<srvProfileId>`^(num)

Internet service profile identifier as defined by `AT^SISS (<srvProfileId>)`.

0...9

`<srvState>`^(num)

Internet service state (for details see `AT^SISO` parameter `<srvState>`).

2	Allocated
3	Connecting
4	Up
5	Closing
6	Down
7	Alerting
8	Connected

`<rxCount>`^(num)

Number of bytes received via `AT^SISR` or `AT^SIST` since last successful `AT^SISO` write command. This is the same value as displayed by the `AT^SISO` read command with the parameter `<rxCount>`.

`<txCount>`^(num)

Number of bytes sent via `AT^SISW` or `AT^SIST` since last successful `AT^SISO` write command. This is the same value as displayed by the `AT^SISO` read command with the parameter `<txCount>`.

`<ackData>`^(num)

Number of data bytes already sent and acknowledged at TCP layer. Value 0 indicates that no sent data is acknowledged yet. Parameter is not applicable to HTTP, SMTP, Socket with UDP. For these services the counter is always set to 0.

`<unackData>`^(num)

Number of data bytes already sent but not yet acknowledged at TCP layer. A value 0 indicates that all sent data is already acknowledged. This is the same value as displayed in the response of the `AT^SISW` write command with the parameter `<unackData>`. Parameter is not applicable to HTTP, SMTP, Socket with UDP. For these services the counter is always set to 0.

Note

- If a service is in state "Down" the responses for `<rxCount>`, `<txCount>`, `<ackData>` and `<unackData>` are the last known values for the service in the states "Connecting", "Up/Listening", "Connected" and "Closing".

9.6 AT^SISO Internet Service Open

The `AT^SISO` write command starts an Internet service configured with `AT^SISS`. Before you can start a service it is necessary to activate the bearer with `AT^SICA`. The command may be aborted by any character sent from the TE to the UE during execution.

Syntax

Test Command <code>AT^SISO=?</code> Response(s) OK
Read Command <code>AT^SISO?</code> Response(s) <code>^SISO: <srvProfileId>, <srvType>[, <srvState>, <socketState>, <rxCount>, <txCount>, <locAddr>, <remAddr>, <rejCounter>]</code> <code>[^SISO: ...]</code> OK
Write Command <code>AT^SISO=<srvProfileId>[, <optParam>]</code> Response(s) OK ERROR +CME ERROR: <err>
PIN → Last - - -

Parameter Description

<code><srvProfileId></code> ^(num)	<code><srvProfileId></code> 0 ... 9 specified with <code>AT^SISS</code> .				
<code><srvType></code> ^(str)	The type of the internet service as specified by the <code>AT^SISS</code> parameter <code><srvParmValue-srvType></code> .				
<code><srvState></code> ^(num)	<p>Internet service state.</p> <p>Please note, that the state of an Internet service may influence the state of the serial DCD line. For details see description of value 2 for parameter <code><value></code> of command <code>AT&C</code>.</p> <table border="0"> <tr> <td style="vertical-align: top;">2</td> <td> Allocated Service profile resources are allocated, i.e. at least the service type has been set (parameter <code><srvParmTag></code>, value "srvType" of <code>AT^SISS</code>). The service is not opened, but ready for configuration. </td> </tr> <tr> <td style="vertical-align: top;">3</td> <td> Connecting State after opening a service with <code>AT^SISO</code> where the connection is being established. If connection setup is successful the service proceeds to the state "4" (Up) and one of the URCs "<code>^SISW</code>" and "<code>^SISR</code>" may follow. If connection setup is not successful, the "<code>^SIS</code>" URC may appear and the service enters <code><srvState></code> 6 (Down). </td> </tr> </table>	2	Allocated Service profile resources are allocated, i.e. at least the service type has been set (parameter <code><srvParmTag></code> , value "srvType" of <code>AT^SISS</code>). The service is not opened, but ready for configuration.	3	Connecting State after opening a service with <code>AT^SISO</code> where the connection is being established. If connection setup is successful the service proceeds to the state "4" (Up) and one of the URCs " <code>^SISW</code> " and " <code>^SISR</code> " may follow. If connection setup is not successful, the " <code>^SIS</code> " URC may appear and the service enters <code><srvState></code> 6 (Down).
2	Allocated Service profile resources are allocated, i.e. at least the service type has been set (parameter <code><srvParmTag></code> , value "srvType" of <code>AT^SISS</code>). The service is not opened, but ready for configuration.				
3	Connecting State after opening a service with <code>AT^SISO</code> where the connection is being established. If connection setup is successful the service proceeds to the state "4" (Up) and one of the URCs " <code>^SISW</code> " and " <code>^SISR</code> " may follow. If connection setup is not successful, the " <code>^SIS</code> " URC may appear and the service enters <code><srvState></code> 6 (Down).				

	In the case of FTP, <code><srvState>=3</code> means that the command channel is being established.
	If the service profile is configured as Standard Listener, then the Listener always stays at <code><srvState>=3</code> and <code><socketState>=3</code> (LISTENER), while the <code><srvState></code> and <code><socketState></code> of the dynamically assigned service profile may change. See examples in Section 9.15.5.
4	<p>Up</p> <p>The service performs its purpose. The data transfer process is the major function at this state.</p> <p>FTP: Data channel is up.</p> <p>Transparent TCP Listener service: the service is listening to remote client connection requests. Not applicable to Standard Listener. See examples in Section 9.15.6.</p>
5	<p>Closing</p> <p>Internet Service is closing the network connection.</p> <p>FTP: Command channel is released.</p>
6	<p>Down</p> <p>This state is entered if</p> <ul style="list-style-type: none"> - the service has successfully finished its session (see note on Socket), - the remote peer has reset the connection or - the IP connection has been closed because of an error (see note below on service or network errors). <p>If a service in this state be sure to close it with <code>AT^SISC</code> before reopening it.</p>
7	<p>Alerting</p> <p>A client tries to connect to the Transparent TCP Listener service. Not applicable to Standard Listener.</p>
8	<p>Connected</p> <p>A client is connected with the Transparent TCP Listener service. Not applicable to Standard Listener.</p>

`<socketState>`^(num)

Socket state identifier.

1	Socket not assigned, i.e. no TCP/UDP connection active.
2	Socket assigned as CLIENT.
3	Socket assigned as LISTENER or UDP Endpoint.
4	Socket assigned as SERVER.

`<rxCount>`^(num)

Number of bytes received via `AT^SISR` or `AT^SIST` since last successful `AT^SISO` write command.

`<txCount>`^(num)

Number of bytes sent via `AT^SISW` or `AT^SIST` since last successful `AT^SISO` write command.

`<locAddr>`^(str)

Recently used local IPv4 address in dotted-four-byte format and TCP port separated by colon, e.g. "192.60.10.10:80", or recently used local IPv6 address in colon format enclosed in square brackets, e.g. "[FE80::2]" and TCP port separated by colon, e.g. "[FE80::2]:80".

<remAddr>^(str)

Remote IPv4 address in dotted-four-byte format and TCP port, separated by colon, e.g. "192.60.10.10:80", or remote IPv6 address in colon format enclosed in square brackets, e.g. "[FE80::2]" and TCP port separated by colon, e.g. "[FE80::2]:80".

If the Socket service is configured as UDP Endpoint, a remote IP address cannot be assigned, and a default value will be shown instead.

<rejCounter>^(num)

Number of automatically rejected client connect attempts to a Transparent TCP Listener service because the service is already connected with a client.

<optParam>^(num)

1 Show only parameters of service profile for given <srvProfileId>.

Notes

- If the bearer cannot be established and AT^SISO returns an error there might be a general mobile network problem. To identify the reason you can take advantage of the AT+CEER command. Using AT+CEER is especially recommended when the <infoID> parameter of the AT^SISE command equals 0.
- If a service or network error occurs during an IP session and the "^SIS" URC or the AT^SISE command display an error message, the service enters <srvState>=5 and then 6, i.e. the IP connection is closed. In this case, the service still allows reading the data stored in the buffer, but writing data is denied. After reading, close the service and open it again.
- If an FTP connection is no longer available after network loss or server shutdown a 3-minute closing timeout for each of the two used sockets takes effect, adding up to 6 minutes. The timeout is effective if the AT^SISC is not sent. Please keep in mind that this time may vary depending on the settings of <tcpMr> and <tcpOt>.
- As in polling mode no error URCs are available you are advised to integrate the commands AT^SISI and AT^SISE into the command sequences for upload and download jobs. So, the AT^SISO command may be followed by AT^SISI to check that the service has entered the <srvState>=4 before sending AT^SISR, AT^SISW or AT^SIST. This helps you to detect errors even though the "^SIS" URCs are disabled. A typical example is that the service fails to be opened because the service profile contains a wrong destination address. In such a case, after opening with AT^SISO and OK response, the service quickly enters the states <srvState>=2, 4 and 6, with an error being returned no earlier than after sending the first AT^SISR or AT^SISW command. In URC mode, an error URC, such as "Host not found" would be received in this situation, but in polling mode the only way to detect the state is using AT^SISI or, alternatively, AT^SISO.

9.7 AT^SISC Internet Service Close

The `AT^SISC` write command closes the TCP/IP connection to the remote peer which was opened with `AT^SISO`. All resources are released, all status information parameters, e.g. `<srvState>`, `<unackData>`, `<ackData>`, `<rxCount>` and `<txCount>` counters, are reset. Only the initial configuration settings are preserved. The service can be restarted any time, using the same configuration or a new one.

Syntax

Test Command

```
AT^SISC=?
```

Response(s)

```
OK
```

Write Command

```
AT^SISC=<srvProfileId>
```

Response(s)

```
OK
```

```
ERROR
```

```
+CME ERROR: <err>
```

PIN → Last

```
± - -
```

Parameter Description

`<srvProfileId>`^(num)

0...9

`<srvProfileId>` specified with `AT^SISO`.

9.8 AT^SISR Internet Service Read Data

The `AT^SISR` command either triggers a read operation (download) or queries the number of bytes in the internal buffer.

The "`^SISR: x, 1`" URC is also used to report status changes of the transparent TCP service while the client is in AT command mode.

The `AT^SISR` write command may return the following errors:

- "+CME ERROR: operation failed" if there is a problem on application, socket, PPP or GPRS/GSM level. The `AT^SISE` command and the "`^SIS`" URC offer additional error information.
- "+CME ERROR: operation temporary not allowed" e.g. if the service has not network resources allocated.
- "+CME ERROR: operation not allowed" e.g. if the service is not configured.

Syntax

```
Test Command
AT^SISR=?
Response(s)
OK

Write Command
AT^SISR=<srvProfileId>, <reqReadLength>
Response(s)
^SISR: <srvProfileId>, <cnfReadLength>[, <remainUdpPacketLength>[, <Udp_RemClient>]]
Number of data bytes are sent as specified by <cnfReadLength>. If peek operator was used no data bytes are sent.
OK
ERROR
+CME ERROR: <err>
```

PIN → Last
- - +

Unsolicited Result Code

`^SISR: <srvProfileId>, <urcCauseId>`

Data availability status of the Internet service configured with `AT^SISR` has changed. The URC is issued when:

- data is available after opening an Internet service or
- less data was confirmed (in `<cnfReadLength>`) than requested (with `<reqReadLength>`) during the last "Read Data" operation and new data is available.

The URC is disabled in polling mode. See `AT^SCFG`, parameter "Tcp/WithURCs", `<tcpWithUrc>`.

Parameter Description

`<srvProfileId>`^(num)

`<srvProfileId>` 0 ... 9 specified with `AT^SISR`. Transparent TCP Listener services are not supported.

<reqReadLength>^(num)

- 0 Peek Operator: Query number of received bytes within internal buffers. The behaviour of the peek operator depends on the selected Internet service, i.e. it may not be supported by all IP Services. For "Socket" service configured for UDP the size of the next available UDP packet is returned.
- 1...1500 Requested number of data bytes to be read via the Internet service specified in <srvProfileId>.

<cnfReadLength>^(num)

- 2 Indicates end of data. Data transfer has been finished (all data have been read) and the service can be closed with AT^SISC.
- 1 Applies only to HTTP: Querying number of available bytes is not supported by the HTTP service.
- 0 Indicates that no further data is available at the moment.
- >0 Number of available data bytes. The range is determined by <reqReadLength>:
 If <reqReadLength> was greater than 0, then <cnfReadLength> may be less or equal to the value requested with <reqReadLength>.
 If <reqReadLength> equals 0 (peek operator) the value indicated by <cnfReadLength> may be greater than 1500.

<urcCauseId>^(num)

Indicates whether or not data is available for reading with AT^SISR and AT^SIST.

- 1 *Meaning of value "1" for all services except Transparent TCP service:*
 Data is available and can be read by sending the AT^SISR command. The URC appears when less data was confirmed (in <cnfReadLength>) than requested (with <reqReadLength>) during the last "Read Data" operation and new data is available.

Meaning of value "1" for Transparent TCP service:
 If the Transparent TCP service is in AT command mode the "^SISR: x, 1" URC notifies the client that the server has sent new data. In this case the client shall enter the AT^SIST command to go to transparent access mode and read the data.
- 2 End of data. Data transfer has completed (all data read). The service can be closed with AT^SISC.

<remainUdpPacketLength>^(num)

Optional third parameter of the AT^SISR write command response displayed only if the Socket service uses the UDP protocol.

The reception of each datagram must be completed before the next datagram can be received. This may be a problem if the buffer of the host application is limited and not designed to handle the maximum packet size of 1500 bytes. To compensate this, the host is advised to request, via <reqReadLength>, an amount less or equal its maximum buffer capacity and wait for the resulting AT^SISR write command response with parameter <remainUdpPacketLength>. The benefit of this approach is that the host may properly receive all parts of a UDP datagram, as after each received data part the number of remaining bytes is synchronized, until reading the datagram is finished.

If the currently read datagram is smaller than the number of bytes requested by the host the `<remainUdpPacketLength>` parameter is omitted.

Further write attempts with `AT^SISR` are denied as long as the `<remainUdpPacketLength>` is unequal 0 or is not omitted. In this case the service returns `" +CME ERROR: operation of service temporary not allowed"`.

- 0 Indicates that all bytes of the current UDP datagram are read.
- (max. data size)-1...1 Indicates that the currently read UDP datagram is not yet complete. The displayed value is the remaining number of bytes. `<remainUdpPacketLength>` is unequal 0 until reading all parts of the current datagram is finished.

`<Udp_RemClient>`^(str)

Service specific parameter of the `AT^SISR` write command response. If the Socket service is configured as UDP endpoint this parameter shows the IP address and the UDP port of the remote host that has sent the current UDP data. See example in Section 9.15.9, [UDP Scenario](#).

9.8.1 Example: Socket Host Reads Small Amounts of UDP Data Packets (URC Mode)

This section applies only to the Socket service using the UDP protocol. The example shows how to read UDP packets if the buffer of the host application can handle only a few bytes. There are two datagrams available for reading.

Buffer size: 6 bytes

Datagram A = 18 bytes (content "THIS_IS_DATAGRAM_A")

Datagram B = 3 bytes (content "NEW")

```

^SISR: 0,1
at^sizr=0,6
^SISR: 0,6,12
THIS_I
OK
at^sizr=0,6
^SISR: 0,6,6
S_DATA
OK
at^sizr=0,6
^SISR: 0,6,0
GRAM_A
OK
at^sizr=0,6
^SISR: 0,3
NEW
OK
  
```

Service profile 0 is configured for Socket service and UDP. The URC notifies host that data is available for reading.

The host requests to read 6 bytes.

The first 6 bytes of datagram A are confirmed and transmitted. Another 12 bytes are still available.

The host requests to read the next part of 6 bytes.

The next 6 bytes of datagram A are confirmed and transmitted. Another 6 bytes are still available.

The host requests to read the next part of 6 bytes.

Last part of datagram A was received, no remainder is left.

Again, the host requests to read 6 bytes. This time, the request refers to datagram B which has only 3 bytes. As the read datagram is smaller than the size requested by the host, the response does not include the `<remainUdpPacketLength>`.

3 bytes are confirmed and transmitted. Datagram B was properly received.

9.9 AT^SISW Internet Service Write Data

AT^SISW triggers a write operation (upload) and queries the amount of data already sent, but not acknowledged at the TCP layer.

AT^SISW write command may return the following errors:

- "+CME ERROR: operation failed" if there is a problem on application, socket, PPP or GPRS/GSM level. The AT^SISE command and the "^SIS" URC offer additional error information.
- "+CME ERROR: operation temporary not allowed" e.g. if the service has not network resources allocated.
- "+CME ERROR: operation not allowed" e.g. if the service is not configured.

Syntax

```

Test Command
AT^SISW=?
Response(s)
OK

Write Command
AT^SISW=<srvProfileId>, <reqWriteLength>[, <eodFlag>[, <Udp_RemClient>]]
Response(s)
^SISW: <srvProfileId>, <cnfWriteLength>, <unackData>
Number of data bytes as specified by <cnfWriteLength>.
OK
ERROR
+CME ERROR: <err>
  
```

PIN → Last
 ± - +

Unsolicited Result Code

^SISW: <srvProfileId>, <urcCauseId>

The URC indicates the following status changes:

- After opening a TCP Client or UDP Client with AT^SISO the "^SISW" URC indicates that the service is ready to accept data. After this initial "^SISW" URC, the TCP Client or UDP Client can proceed in Transparent Mode or Non-Transparent Mode.
 The initial "^SISW" URC is not issued after a Transparent Listener or UDP Endpoint was opened, because for listening services the "^SIS" URC will be issued.
- During AT^SISW write cycles the "^SISW" URC indicates that the service is ready to accept new data, or that data transfer has finished successfully.

The URC is disabled in polling mode. See AT^SCFG, parameter "Tcp/WithURCs", <tcpWithUrc>.

Parameter Description

<srvProfileId>^(num)
 <srvProfileId> 0 ... 9 specified with AT^SISS. Transparent TCP Listener services are not supported.

<reqWriteLength>^(num)
 0...1500
 Specifies the number of bytes to be sent with AT^SISW or, if set to 0, requests the amount of data already sent with AT^SISW but not yet acknowledged:

9.9 AT^SISW

- Parameter `<reqWriteLength>` may be 1...1500 bytes to specify the amount of data to be sent with `AT^SISW`.
- If parameter `<reqWriteLength>` equals 0, `AT^SISW` does not expect any data, but a normal query is performed. This allows the application to explicitly request, in particular at the end of an upload job, the amount of unacknowledged data at the TCP layer indicated by `<unackData>`.
- If Socket service is selected with UDP protocol
 - `<reqWriteLength>=0` can be used to send an empty UDP packet;
 - it is recommended that the size of each data packet be limited to 1460 bytes. Otherwise, it is possible that the following URC occurs: "`^SIS: <id>, 0, 9, The supplied buffer was too small / large`".

`<eodFlag>`^(num)

End of data indication flag. See also Section 9.9.1.

- | | |
|-----|---|
| [0] | No end of data. Other data may follow to be transmitted via the Internet service. Note for UDP Endpoint service: Value 0 must be set before <code><Udp_RemClient></code> parameter although <code><eodFlag></code> is not effective for UDP Endpoint. |
| 1 | End of data is signalled to the Internet Service. Further <code>AT^SISW</code> write commands return an error response. However, reading data may be possible. The <code><eodFlag></code> is effective only if the <code><reqWriteLength></code> equals <code><cnfWriteLength></code> , in particular if the <code><reqWriteLength></code> equals 0.
End-of-data flag must be enabled for following actions: <ul style="list-style-type: none"> - FTP "cmd","put" (sending single file to FTP server) - SMTP "cmd","at" (sending attachment from AT command interface) |

`<Udp_RemClient>`^(str)

Service specific parameter of the `AT^SISW` write command. If the Socket service is configured as UDP endpoint this parameter is mandatory and specifies the IP address (in dotted format) and the UDP port of the remote host. For each write request another IP address and UDP port may be given. See example in Section 9.15.9, [UDP Scenario](#).

`<cnfWriteLength>`^(num)

- | | |
|----------|---|
| 0...1500 | Confirmed number of data bytes which can be transmitted via the Internet service configured in <code><srvProfileId></code> . This number may be less or equal to the value requested with <code><reqWriteLength></code> . The application has to deliver exactly the number of bytes indicated by <code><cnfWriteLength></code> . A 0 value means that no data can be written at this time, i.e. it serves as a flow control mechanism. |
|----------|---|

`<unackData>`^(num)

Number of data bytes already sent but not yet acknowledged at the TCP layer. The value is constantly changing until the entire upload job has completed. If the value equals 0 all data sent so far is acknowledged.
`<unackData>` includes the `<cnfWriteLength>` value of the pending write operation. Therefore, the very first write operation of an upload job returns identical values for `<cnfWriteLength>` and `<unackData>`. This mechanism allows the host application to easily verify whether or not the remote host has successfully received the data.
Parameter is not applicable to HTTP, SMTP, Socket with UDP protocol. For these services the counter is always set to 0.

`<urcCauseId>`^(num)

- | | |
|---|---|
| 1 | The service is ready to accept new user data. |
| 2 | Data transfer has been finished successfully and Internet service may be closed without loss of data. |

Note

- Do not send any characters after AT^SISW command line termination (ATS3) until ^SISW URC is received. This is necessary to avoid that any characters related to the AT command can be interpreted as being part of the data stream to be transferred. Also refer to Section 1.4, AT Command Syntax.

9.9.1 Usage of parameter <eodFlag>

Service type	
Socket	<p>Parameter is optional for Socket services.</p> <p>Not applicable to Socket with UDP protocol, i.e. value is ignored.</p> <p>After the service accepts the end-of-data flag the service state changes to "Closing". No further user data is accepted.</p> <p>After releasing the TCP link the service remains in state "Down".</p>
FTP	<p>Parameter is mandatory for FTP "put" (sending single file to FTP server).</p> <p>After accepting the end-of-data flag the service state changes to "Closing" and starts to end the running FTP session.</p> <p>No further user data is accepted.</p> <p>After the FTP session is completed on FTP protocol level the service state switches to "Down". In case of successful completion the URC "^SISW: x,2" is generated.</p>
SMTP	<p>Parameter is mandatory for SMTP "cmd","at" (sending attachment from AT command interface).</p> <p>SMTP service sends some "closing" commands to the SMTP server which are necessary to mark the email as successfully sent on the server. The service enters "Closing" state and remains in it until the final protocol exchange with the SMTP server has been completed. The "OK" response following AT^SISW indicates that the SMTP service has accepted the last data - IT DOES NOT indicate the successful completion of the SMTP service.</p> <p>Successful completion will be indicated either by the appropriate URC "^SISW:x,2" or due to the fact that the SMTP service state changes to "Down" state without any error.</p>
HTTP	<p>Parameter is optional.</p>

9.10 AT^SIST

9.10 AT^SIST Enter Transparent Mode

AT^SIST activates / deactivates Transparent Mode.

After entering the AT^SIST command, the CONNECT response notifies that the service has entered Transparent Mode and is ready to transparently send and receive payload data over the AT command interface.

There are several ways to quit the Transparent Mode and revert to AT Command Mode:

- +++ escape sequence (also transmitted over the air)
- DTR ON-OFF transitions (see AT&D for configuring DTR line)
- "etxChar" parameter set within the server address (see AT^SISS, <srvParmTag> "address" for Socket service URLs).

Switching back and forth between both modes does not affect the underlying socket and has no influence on the service <srvState>.

If the service is in AT Command Mode the "^SISR: x, 1" URC appears once to indicate that the remote side has sent new data. In this case, the client or listener shall enter AT^SIST to go to Transparent Mode and read out the new data.

If the connection is released by the remote side the following applies:

- If the service is in Transparent Mode (CONNECT mode): UE returns to AT Command Mode, issues a specific "NO CARRIER" result code and goes to <srvState> 6 ("Down") in case of TCP or UDP Client, and to 4 ("Up/Listening") in case of Transparent Listener. The "NO CARRIER" result code starts with 0x10 (DLE) and 0x04 (EOT) and ends with the command line termination character (ATS3), followed by the response formatting character (ATS4).
- If the service is in AT Command Mode the "^SISR: x, 1" URC appears to indicate that the state of the service has changed. In this case, the client or listener shall go to Transparent Mode with AT^SIST in order to read remaining data (if any) and get the "NO CARRIER" result code. After this, the service changes to <srvState> 6 ("Down"). Otherwise, if the client or listener does not go to Transparent Mode after receiving "^SISR: x, 1" URC the service remains in <srvState> 4 ("Up") even though the remote side has shut down. In some cases, depending on the remote side and the network, it is possible that "^SIS" URCs may be reported, for example "^SIS" URCs with <urcInfoId> 15 ("Remote host has reset the connection") and 19 ("Socket has been shut down"). See Section 9.14, Internet Service URC "^SIS" for a list of possible URCs.
- In all above scenarios, the Transparent service shall be closed with AT^SISC. Trying to return to Transparent Mode with AT^SIST would only end up with "NO CARRIER" once again and is not recommended.
- Use AT^SISO and AT^SISI to check the <srvState>.

Syntax

Test Command

```
AT^SIST=?
```

Response(s)

```
OK
```

Write Command

```
AT^SIST=<srvProfileId>
```

Response(s)

```
CONNECT
```

(indicates that UE has entered Transparent Mode)

```
OK
```

```
ERROR
```

```
+CME ERROR: <err>
```

PIN → Last

```
- - +
```

Parameter Description

<srvProfileId>^(num)

<srvProfileId> 0 ... 9 specified with AT^SISS.

9.11 AT^SISH Disconnect Remote Client

AT^SISH is intended only for a Transparent TCP Listener service. It allows to reject an incoming remote client connection request or to disconnect an established client connection from server side.

Syntax

Test Command

```
AT^SISH=?
```

Response(s)

```
OK
```

Write Command

```
AT^SISH=<srvProfileId>[, <mode>]
```

Response(s)

```
OK
```

```
ERROR
```

```
+CME ERROR: <err>
```

PIN → Last

```
- - -
```

Parameter Description

<srvProfileId>^(num)

0...9

A Transparent TCP Listener service <srvProfileId> defined with **AT^SISS**.

<mode>^(num)

Specifies disconnect mode.

[0]

Socket is closed with graceful option

1

Socket is closed without graceful option

9.12 AT^SISX Internet Service Execution

The `AT^SISX` command can be used to send ICMP (Internet Control Message Protocol) Echo Requests to a target IP address or DNS host name (also referred to as Ping command). This command can also be used to resolve DNS host names to IP addresses (HostByName) or resolve the network time, NTP protocol, in UTC.

The `AT^SISX` command can be used any time while a connection profile (bearer) is active. If issued although no connection is active, then `AT^SISX` returns ERROR.

If the `AT^SISX` write command is executed for Ping, then the command returns one row for every ICMP Echo Request. The last Ping response line is followed by an empty line, then another two lines appear to report a statistic calculated from the Echo Request responses. After starting the ping command the AT channel is blocked until all ICMP requests are executed. To stop the periodic ping early, send any character (user break).

It is also possible to cancel the HostByName or NTP service by user break. But this may temporarily block further `AT^SISX` write commands which is indicated by the error response "+CME ERROR: operation temporary not allowed". As soon as the background activity for the last started HostByName service is finished the `AT^SISX` write command can be used again.

Syntax

Test Command

```
AT^SISX=?
```

Response(s)

```
^SISX: "Ping", (list of supported <conProfileId>s), , (range of supported <request>s), (range of supported <timelimit>s)
^SISX: "HostByName", (list of supported <conProfileId>s)
^SISX: "NsLookup", (list of supported <conProfileId>s)
^SISX: "Ntp", (list of supported <conProfileId>s)
OK
```

Write Command

```
AT^SISX=<service>, <conProfileId>, <address>[, <request>[, <timelimit>]]
```

Response(s)

In case of <pingInfoType>= 1: ICMP Echo Requests (1 - 30 rows)

```
^SISX: "Ping", <pingInfoType>, <conProfileId>, <ip-address>, <roundTripTime>
[...]
```

In case of <pingInfoType>= 2: Packet statistic (1 row)

```
^SISX: "Ping", <pingInfoType>, <conProfileId>, <sent>, <received>, <lost>, <lostPercent>
```

In case of <pingInfoType>= 3: Time statistic (1 row)

```
^SISX: "Ping", <pingInfoType>, <conProfileId>, <minRTT>, <maxRTT>, <meanRTT>
```

In case of <service>= "HostByName"

```
^SISX: "HostByName", <ip-address>
[...]
```

In case of <service>= "NsLookup"

```
^SISX: "NsLookup", <ip-address>, <tTL>
[...]
```

In case of <service>= "Ntp"

```
^SISX: "Ntp", <ntp>
```

OK

ERROR

```
+CME ERROR: <err>
```

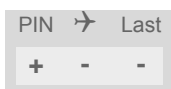

Parameter Description

`<service>`^(str)

"Ping"	Ping host.
"HostByName"	Get first address from a host.
"NsLookup"	Get all addresses including TTL from a host.
"Ntp"	Network time protocol.

`<conProfileId>`^(num)

The connection profile identifier as defined with `AT^SISX` for the connection to be used (see `<conProfileId>`). If the specified connection is not yet open, it will be opened implicitly.

`<address>`^{(str)(+CSCS)}

In case of "Ping" this is the target host as FQDN or IP address (i.e. "192.168.1.3"), in case of "HostByName" this is the FQDN to be resolved into the IP address.

`<ip-address>`^(str)

The IP address of the host (i.e. "192.168.1.3").

`<request>`^(num)

[1]...30	Number of "Ping" ICMP Echo Requests to be sent. Not supported for "HostByName".
4	IPV4 only in case of "HostByName" or "NsLookUp"
6	IPV6 only in case of "HostByName" or "NsLookUp"

`<timelimit>`^(num)

200...[5000]...10000 Amount of time, in milliseconds, to wait for an ICMP Echo Response message related to a previously sent Echo Request message. Parameter is not supported for "HostByName".

`<pingInfoType>`^(num)

Indicate the type and format of the information given in the command responses (see syntax of the `AT^SISX` write command above).

1	Ping status received for the ICMP Echo Request(s). Depending on parameter <code><request></code> 1 - 30 rows. Address and Round Trip Time are returned for each request.
2	one row packet statistic calculated from the ping response(s) received for <code><pingInfoType></code> =1.
3	one row time statistics calculated from the ping response(s) received for <code><pingInfoType></code> =1 (displayed only if at least one Echo response message was received).

`<roundTripTime>`^(num)

Round Trip Time in milliseconds. If the Echo Response message is not received within the time specified by `<timelimit>` the value -1 is returned (e.g. when the bearer shuts down during command execution).

<sent>^(num)

Number of sent packets.

<received>^(num)

Number of received packets.

<lost>^(num)

Number of lost packets.

<lostPercent>^(num)

Lost packets in percent.

<minRTT>^(num)

Minimum Round Trip Time in milliseconds.

<maxRTT>^(num)

Maximum Round Trip Time in milliseconds.

<meanRTT>^(num)

Average Round Trip Time in milliseconds.

<ntp>^(num)

time in extended format UTC

<tTl>^(num)

The TTL value for this address in seconds.

9.13 AT^SISE Internet Service Error Report

The [AT^SISE](#) write command returns the current error status of the specified Internet service profile. If the service profile is not defined or the value is invalid "+CME ERROR" response is returned.

The error status is identical to the content of the "[^SIS](#)" URC last issued.

If a service fails the commands [AT^SISR](#), [AT^SISW](#) or [AT^SIST](#) will return an error response. However, if the [AT^SISE](#) command returns `<infoID>=0` it is recommended to use the [AT+CEER](#) command because a general network problem might be the reason.

Syntax

Test Command
<code>AT^SISE=?</code>
Response(s)
OK
Write Command
<code>AT^SISE=<srvProfileId></code>
Response(s)
<code>^SISE: <srvProfileId>, <infoID>[, <info>]</code>
OK
ERROR
<code>+CME ERROR: <err></code>
PIN → Last
- - -

Parameter Description

`<srvProfileId>(num)`

Internet service profile identifier as defined by [AT^SISS <srvProfileId>](#).

0...9

`<infoID>(num)`

Reason for Internet service error. This is a subset of the `<urcInfoId>`s which can be found in Section 9.14, [Internet Service URC "^SIS"](#).

The value 0 indicates there is no special Internet service error. In this case the application may use [AT+CEER](#) to check for general network problems.

`<info>(str)`

Information text related to `<infoID>`. This is a subset of the `<urcInfoText>`s which can be found in Section 9.14, [Internet Service URC "^SIS"](#).

Note

- In particular cases, the [AT^SISE](#) command may deliver information and warnings. This applies the following services:
 FTP: Information 2100
 SMTP: Warnings
 If an error occurs the information and warning messages are overwritten by error messages.

9.14 Internet Service URC "^SIS"

9.14 Internet Service URC "^SIS"

This section first describes the syntax and the parameters of the "^SIS" URC. The second part consists of tables listing the information elements delivered within the "^SIS" URC and the command response of AT^SISE.

The presentation of the "^SIS" URC containing the parameter <urcCause>=0 can be disabled or enabled depending on whether polling mode or URC mode is preferred. To do so, use the AT^SCFG command, parameter "Tcp/WithURCs" (refer to <tcpWithUrc>). However, if related to <urcCause>=1, 2, 3 or 4, the "^SIS" URC will always be delivered regardless of the setting made with AT^SCFG.

Unsolicited Result Code

Indicates an event, an error or an information element. The same information can be obtained via AT^SISE.

^SIS: <srvProfileId>, <urcCause>[, [<urcInfoId>] [, <urcInfoText>]]

The URC may appear if an event or an error occurs, for example after opening an Internet service with AT^SISO or any time during operation. The URC also indicates a request for a mobile terminated Internet service client connection, or a failure if a mobile terminated request is rejected. Furthermore, the URC may deliver an information element resulting from a specific command given in the service profile.

A list of possible causes can be found in the tables below. The tables contain the <urcInfoId> and, if applicable, a specific <urcInfoText>. If marked with *) the precise text related to a <urcInfoId> varies greatly depending on the scenario and the implementation of the remote server. In these cases, only a brief explanation of the scenario can be found in the table column "Description".

Parameter Description

<urcCause>^(num)

URC cause identifier.

0	An event has occurred after opening or while using an Internet service. The event number is presented via <urcInfoId> and may be an error, a warning, an information element or a note. Optionally additional information may be supplied via <urcInfoText>.
1	Indicates that an opened Non-Transparent Listener service is receiving a connection request from a remote client. The incoming socket connection is dynamically assigned to the next free Internet service profile. In this case, the parameter <urcInfoId> inside the "^SIS" URC equals the <srvProfileId> of the dynamically assigned service profile. This ID shall be used to accept the connection request with AT^SISO or to reject it with AT^SISC. The connection status may be requested by using the AT^SISI read or write command or the AT^SISO read command. Among other details, the response indicates the IP address of the remote client (parameter <remAddr>). This may be helpful to decide whether to accept or reject the request.
2	Incoming Socket service client connection has failed. The client request was rejected automatically because no free Internet service profile was available.
3	Indicates that an opened Transparent TCP Listener service is receiving a connection request from a remote client. The parameter <urcInfoId> then indicates whether auto answering is active for the service (<urcInfoId>=1) or not. Parameter <urcInfoText> contains the remote IP address and the port of the connecting client. Example: "^SIS: 5,3,0,\"192.168.105.17:1712" means that a client from host 192.168.105.17 tries to connect from port 1712 to our listening Transparent TCP Listener with profile 5. Auto answering is disabled.

9.14 Internet Service URC "^SIS"

- 4 Indicates for a Transparent TCP Listener service, that a remote client which is allowed due to the used address filter (see option "addrfilter" for AT^SIS), was internally rejected, e.g. because the connect timeout has expired (see option "connecttimeout" for AT^SIS). The URC is not generated if the remote client is rejected because its IP address is not matching the address filters. This cause is also used if UE is not in Transparent Mode and a connected client has closed the connection remotely.
- 5 Only for TCP Listeners, Non-Transparent UDP endpoint. The service is ready to use.

<urcInfoId>^(num)

Information identifier related to <urcCause>. See tables below for further detail. The <urcInfoId> number ranges indicate the type of information element:

0: Service is working properly.

1 - 2000: Error, service is aborted and enters <srvState>=6 (Down). Value 1000 notifies that service profile contains invalid parameter(s).

2001 - 4000: Information related to progress of service.

4001 - 6000: Warning, but no service abort.

6001 - 8000: Notes

Additional information for Socket service: As stated above, if a Socket connection request from a remote client is received (see <urcCause>=1) the <urcInfoId> shows the <srvProfileId> of the dynamically assigned free service profile.

If <urcCause> is 3, the <urcInfoId> is used as auto answer indicator. If the value is 0, auto answering is disabled. If the value is 1, auto answering is enabled.

<urcInfoText>^(str)

Information text related to <urcCause>. See tables below for further detail. The maximum length of an information text is 255 bytes. Any longer messages will be truncated.

If <urcCause> is 3, <urcInfoText> is used to indicate the IP address and port of the connecting client, e.g. "192.168.105.17:1712".

9.14.1 Information Elements Related to the Service Application

The following table lists the information elements which may be returned by all supported services within the "^SIS" URC and the command response of AT^SISE. It should be noted that TCP/IP socket problems may occur in all Internet service connections (Socket, Transparent TCP or Transparent UDP, FTP, HTTP or SMTP).

<urcInfoId>	<urcInfoText>	Description
<i>Information Elements Returned by the TCP/IP socket</i>		
2	Invalid socket descriptor	Socket error
3	Bad address specified	Socket error
4	Invalid operation	Socket error
5	No free socket descriptors	Socket error
6	The operation would block	Socket error
7	A previous attempt at this operation is still ongoing	Socket error
8	Socket is not bound	Socket error
9	The supplied buffer is too small / large	Socket error
10	Flags not supported	Socket error
11	Operation not supported	Socket error
12	The address is already in use	Socket error

9.14 Internet Service URC "^SIS"

<urcInfoId>	<urcInfoText>	Description
13	The network is unavailable	Socket error
14	An established connection was aborted (transmission time-out or protocol error)	Socket error
15	Remote host has reset the connection	Socket error
16	No buffer space available	Socket error
17	The socket is already connected	Socket error
18	For TCP/IP sockets, the socket is not connected	Socket error
19	Socket has been shut down	Socket error
20	Connection timed out	Socket error
21	Remote host has rejected the connection	Socket error
22	Remote host is unreachable	Socket error
23	An unexpected error occurred	Socket error
24	Host not found	DNS error
25	An error occurred that may be transient; a further attempt may succeed.	DNS error
26	An unrecoverable error occurred	DNS error
<i>General Information Elements</i>		
46	Fatal: The service has detected an unknown error	
47	*)	Indicates that the remote service has closed the connection. The host shall close the service.
48	Remote peer has closed the connection	Remote peer has closed the connection unexpectedly, and no data are available. The host shall close the service. Note that the "^SIS" URC only indicates the <urcInfoId>, but the AT^SISE command indicates both the <urcInfoId> and the <urcInfoText>.
49	Fatal: No memory is available for service action	
50	Fatal: Service has detected an internal error	
51	Application Task ID is not registered	
52	Fatal: Entity not supported	
53	No free Entity available	
54	Index not supported	
55	Service is not writeable	
56	Syntax error in URL	
57	Configuration Error	
58	No more data available	
59	Peek operation rejected	
60	Service don't accept further data	
61	Fatal: Service has no socket connection	
62	Unknown internal TLS error	SSL error
63	Wrong format of certificate data	SSL error

9.14 Internet Service URC "^SIS"

<urcInfoId>	<urcInfoText>	Description
64	Certificate validity period is in future	SSL error
65	Certificate validity period expired	SSL error
66	Peer certificate is not confirmed	SSL error
67	Wrong signature key format	SSL error
68	Unsupported signature key type	SSL error
69	Wrong protocol data format	SSL error
70	Wrong protocol data format	SSL error
71	No memory available for TLS	SSL error
72	Buffer error in TLS	SSL error
73	Wrong input data for RSA operation	SSL error
74	TLS/SSL protocol error	SSL error
75	Internat error in TLS	SSL error
76	Certificate format error	SSL error
77	The certificate does not exist	SSL error
78	Unknown TLS error code!	SSL error
80		Connection profile not defined.
84	PPP LCP FAILED	PPP error
85	PAP Authentication failed	PPP error
86	CHAP Authentication failed	PPP error
87	IPCP failed	PPP error
89	PDP: can not obtain controlling task	
90	PDP: internal error 1	
91	PDP: internal error 2	
92	PDP: no authentication req	
93	PDP: internal error 3	
94	PDP: conection failed	
95	PDP: internal error 4	
96	PDP: no IP assigned	
97	PDP: no network	
98	PDP: network is not up	
99	PDP: internal error 5	
119	PDP: no DNS received	
120	DNS: no data	
121	DNS: timeout	
122	DNS: connection refused	
123	DNS: terminated lookup	
124	DNS: domain name is too long	
125	DNS: invalid server	
126	DNS: undefined error	

General Information Elements

9.14 Internet Service URC "^SIS"

<urcInfoId>	<urcInfoText>	Description
1000	PARA-ERR: <Info>	Notifies that service profile contains a wrong parameter. <Info> text indicates the service profile parameter that contains an error.
4062	TLS: empty certstore	Notifies that certificate store is empty when AT^siss=0,sec-opt,0 as an explicit non-usage of certificate check is not used.
6001		General progress information for connection setup.

*) Text varies depending on scenario.

9.14.2 Information Elements Related to FTP Service

<urcInfoId>	<urcInfoText>	Description
2100	<info>	<info> text depends on FTP server implementation

9.14.3 Information Elements Related to HTTP Service

<urcInfoId>	<urcInfoText>	Description
<i>Error URCs</i>		
200	HTTP-ERR: Not connected - cannot send request HTTP-ERR: failed on sending request	
201	<HTTP Response Str>	Client error
202	<HTTP Response Str> HTTP-ERR: Service unavailable	Server error
203	HTTP-ERR: Redirect failed - too many redirects HTTP-ERR: Redirect failed - not allowed HTTP-ERR: Redirect failed - location missing	Max. number of allowed redirects: 6
204	HTTP-ERR: auth failed - user name or password missing HTTP-ERR: auth failed - user name or password wrong HTTP-ERR: Authority required for this URL HTTP-ERR: No access to this URL allowed	
<i>Info URCs</i>		
2200	HTTP Redirect to: <Host>:<Port> <Path>	
2201	HTTP Response <Response code> Example: ^SIS: 2,3,2201, "HTTP Response: HTTP/1.1 200 OK"	

9.14.4 Information Elements Related to SMTP Service

<urcInfoId>	<urcInfoText>	Description
<i>Errors</i>		
400	***)	Indicates that the SMTP service could not be executed successfully.
<i>Warnings</i>		
4400	***)	SMTP specific warning

***) Text varies depending on scenario.

9.15 Examples of how to Configure and Use Internet Service Profiles

9.15 Examples of how to Configure and Use Internet Service Profiles

Below you can find selective examples of how to configure and use Internet service profiles. To visualize the difference between URC mode and polling mode the operation of services (after opening with `AT^SISO`) is explained in separate examples for either mode.

9.15.1 Selecting URC Mode or Polling Mode

To enable or disable the presentation of URCs for the Internet services use the `AT^SCFG` command, type "TcpIp/WithURCs" and select "on" or "off" for parameter `<tcpWithUrc>`.

<code>at^scfg=tcp/withurcs</code>	Query the current setting.
<code>^SCFG: "Tcp/WithURCs", "on"</code>	URC mode is enabled (delivery default).
OK	
<code>at^scfg=tcp/withurcs,off</code>	Select polling mode (by switching off URC mode).
<code>^SCFG: "Tcp/WithURCs", "off"</code>	Polling mode is accepted.
OK	

9.15.2 Configuring an Internet Connection Profile

<code>AT+COPS?</code>	Checking network registration.
<code>+COPS: 0,0,"E-Plus",0</code>	ME is registered to German provider E-Plus.
OK	
<code>AT+CGATT=1</code>	Attaching to GPRS network (optional).
OK	
<code>AT+CGDCONT=1,"IP","internet.eplus.de"</code>	Specifying PDP context 1 with APN for E-Plus.
OK	
<code>AT^SICS=1,"dns1","198.023.097.002"</code>	Specifying primary DNS address (optional).
OK	
<code>AT^SICS=1,"dns2","212.023.097.003"</code>	Specifying secondary DNS address (optional).
OK	
<code>AT^SICA=1,1</code>	Activating PDP context 1.
OK	
<code>AT+CGPADDR=1</code>	Requesting dynamic IP address assigned to local client for context 1.
<code>+CGPADDR: 1,"10.129.137.217"</code>	Response returns currently assigned IP address.
OK	

9.15.3 Configuring Non-Transparent Listener

Keep in mind that if the host is configured as Non-Transparent Listener another service profile must be left free to be dynamically assigned as Server when the Non-Transparent Listener receives a connection request from a remote client.

Configure the service profile 4 for use as Non-Transparent Listener:

<code>AT^SISS=4, srvType, "Socket"</code>	Select service type Socket.
OK	
<code>AT^SISS=4, conId, "1"</code>	Select connection profile.
OK	

9.15 Examples of how to Configure and Use Internet Service Profiles

```
AT^SISS=4,address,"socktcp://lis-
tener:65534"
```

The host specifies its local port 65534 to be used for the Socket listener service. The local IP address will be dynamically assigned when the service is opened with [AT^SISO](#).

```
OK
```

Open the Listener service and query the IP address dynamically assigned to the Listener:

```
AT^SISO=4
```

Open the Listener service.

```
OK
```

```
AT^SISO?
```

Query the current status of services. All service profiles are unused, except for service profile 4 which is running in listener mode, where `<srvState>=3` (listening) and `<socketState>=3` (LISTENER). The response also indicates the IP address dynamically assigned to the listener.

```
^SISO: 0,""
```

```
^SISO: 1,""
```

```
^SISO: 2,""
```

```
^SISO: 3,""
```

```
^SISO: 4,"Socket",3,3,0,0,"10.10.0.187:65534","0.0.0.0:0"
```

```
^SISO: 6,""
```

```
^SISO: 7,""
```

```
^SISO: 8,""
```

```
^SISO: 9,""
```

```
OK
```

9.15.4 Configuring TCP Client for Calling a TCP Listener

Configure the client's service profile for calling a TCP Listener on another host:

```
AT^SISS=1,svrType,"Socket"
```

Select service type Socket.

```
OK
```

```
AT^SISS=1,conId,"1"
```

Select connection profile.

```
OK
```

```
AT^SISS=1,address,"socktcp://
10.10.0.187:65534"
```

Add the IP address and the TCP port of the remote host (from example in Section 9.15.3, [Configuring Non-Transparent Listener](#)).

```
OK
```

9.15.5 Transparent TCP Listener: Accepting / Rejecting Incoming Remote Client

Host 1: Configure Transparent TCP Listener with Autoconnect disabled:

```
AT^SISS=1,"svrType","Socket"
```

Select service type Socket.

```
OK
```

```
AT^SISS=1,conId,"1"
```

Select connection profile.

```
OK
```

```
AT^SISS=1,"address","socktcp://lis-
tener:2000;etx=26;autoconnect=0"
```

"etx" configures Transparent mode. Autoconnect disabled.

```
OK
```

```
AT^SISS=1,"tcpMR","3"
```

```
OK
```

```
AT^SISS=1,"tcpOT","5555"
```

```
OK
```

Host 1: Open Transparent TCP Listener and query IP address dynamically assigned to Listener:

9.15 Examples of how to Configure and Use Internet Service Profiles

```

AT^SISO=1
OK
^SIS: 1,5           Listener ready, listening (value 5).
AT^SISO=1,1       Query status of profile 1.
^SISO:           Profile is running in listener mode, where
1,"Socket",4,3,0,0,"10.10.0.187:65534", "0.0
.0.0:0"          <srvState>=4 (listening) and <socketState>=3
                 (LISTENER). Dynamic IP address is shown.

OK

```

Host 2: Configure TCP Client:

```

AT^SISS=0,srvType,"Socket"   Select service type Socket.
OK
AT^SISS=0,conId,"1"         Select connection profile.
OK
AT^SISS=0,"address","socktcp://
10.10.0.187:65534"         Set Listener's IP address.
OK
AT^SISS=0,"tcpMR","3"
OK
AT^SISS=0,"tcpOT","5555"
OK

```

Host 2: Start TCP Client

```

AT^SISO=0
OK
^SISW: 0,1           URC indicates that sending data is possible.

```

Host 1: Listener rejects incoming connection request from host 2:

```

^SIS: 1,3,0,"10.66.90.165:46723"   URC indicates incoming connection request.
AT^SISH=1                     Listener rejects connection request.
OK
AT^SISO=1,1                   Query status of profile 1.
1,"Socket",4,3,0,0,"10.10.0.187:65534", "0.0
.0.0:0"                       Listener is listening again.
OK

```

Host 1: Listener accepts incoming connection request from host 2:

```

^SIS: 1,3,0,"10.66.90.165:46723"   URC indicates incoming connection request.
AT^SISO=1                       Listener accepts connection request, profile
                                 changes to Server mode.
OK
^SISW: 1,1                       URC indicates that data transmission is possible.
AT^SISO=1,1                       Query status of profile 1.
1,"Socket",8,4,0,0,"10.10.0.187:65534", "10.
66.90.165:46723",0             Service connected (value 8) and in Server mode /
                                 value 4).
OK
AT^SIST=0                         Change to transparent access mode.
CONNECT                           Service enters transparent access mode.
Hello ....                       For further handling see examples below, e.g. Sec-
                                 tion 9.15.11, Opening and Closing Transparent TCP
                                 Service, Section 9.15.12, Transparent TCP Client
                                 Receives Data While in AT Command Mode

```

9.15 Examples of how to Configure and Use Internet Service Profiles

9.15.6 Transparent TCP Listener: Autoanswering Incoming Remote Client

Host 1: Configure Transparent TCP Listener with Autoconnect enabled.

```
AT^SISS=1,"srvType","Socket"           Select service type Socket.
OK
AT^SISS=1,conId,"1"                     Select connection profile.
OK
AT^SISS=1,"address","socktcp://lis-    "etx" configures Transparent mode. Autoconnect
tener:2000;etx=26;autoconnect=1"       enabled.
OK
AT^SISS=1,"tcpMR","3"
OK
AT^SISS=1,"tcpOT","5555"
OK
```

Host 1: Open Transparent TCP Listener and query IP address dynamically assigned to Listener:

```
AT^SISO=1
OK
^SIS: 1,5                               Listener ready, listening (value 5).
AT^SISO=1,1                             Query status of Listener profile.
^SISO:                                   Listener ready, listening (value 4). Dynamic IP
1,"Socket",4,3,0,0,"10.10.0.187:2000", address is shown.
"0.0:0"
OK
^SISW: 1,1
```

Host 2: Configure TCP Client.

```
AT^SISS=0,srvType,"Socket"             Select service type Socket.
OK
AT^SISS=0,conId,"1"                     Select connection profile.
OK
AT^SISS=0,"address","socktcp://       Set Listener's IP address.
10.10.0.187:2000"
OK
AT^SISS=0,"tcpMR","3"
OK
AT^SISS=0,"tcpOT","5555"
OK
```

Host 2: Start TCP Client

```
AT^SISO=0
OK
^SISW: 0,1
```

Host 1: Transparent TCP Listener automatically accepts connection request from host 2:

```
^SIS: 1,3,1,"10.66.90.165:46723"      URC indicates incoming connection request.
CONNECT                                  Service autoconnects to client and enters Transpar-
                                          ent Mode.
Hello ....                               For further handling see examples below, e.g. Sec-
                                          tion 9.15.11, Opening and Closing Transparent TCP Service, Section 9.15.12, Transparent TCP Client Receives Data While in AT Command Mode
                                          Type +++ to return to AT command mode (+++ not
                                          visible in example).
OK
AT^SISO=1,1                             Query status of profile 1.
```

9.15 Examples of how to Configure and Use Internet Service Profiles

```

^SISO:
1, "Socket", 8, 4, 0, 0, "10.10.0.187:2000", "10.6
6.90.165:46723", 0
OK

```

Transparent TCP Listener connected to client (value 8) and in Server mode (value 4).

9.15.7 Socket Client Sends Data via TCP Connection (Polling Mode)

The example uses service profile 0 configured for Socket service and TCP.

```

AT^SISO=0
OK

AT^SISI=0
^SISI: 0, 3, 0, 0, 0, 0
OK
AT^SISI=0
^SISI: 0, 4, 0, 0, 0, 0
OK
AT^SISW=0, 10
^SISW: 0, 10, 10
0123456789
OK
AT^SISW=0, 10, 1
^SISW: 0, 0, 10
OK
AT^SISW=0, 10, 1
^SISW: 0, 10, 20
0123456789
OK
AT^SISW=0, 0, 0
^SISW: 0, 0, 10
OK
AT^SISI=0
^SISI: 0, 5, 0, 20, 10, 10
OK
AT^SISI=0
^SISI: 0, 6, 0, 20, 20, 0
OK
AT^SISC=0
OK

```

The host opens service profile 0.
Note: URC ^SISW:0,1 does not appear! The host must poll the service state by means of AT^SISI until the service is in <srvState> "Up".

The service is still in <srvState> "Connecting".

The service is now in <srvState> "Up" and is ready to accept data.

The host requests to write 10 bytes.
Response that 10 bytes can be sent and are unacknowledged.

The host requests to write next 10 bytes and enables the <eodFlag>.
But the service refuses the request, even the end-of-data flag remains without effect.

Next try (polling).
Response that the service accepts 10 bytes and this data and the previously sent data are unacknowledged.

Polling to request unacknowledged data.
There are 10 bytes still unacknowledged.

Polling for <srvState> change ("Closing" -> "Down").
20 bytes are transferred via serial interface, 10 bytes are acknowledged by remote peer, 10 bytes are on the way.

Polling for <srvState> change ("Closing" -> "Down").
The Service is in state "Down" and all data is confirmed by the remote peer.

Closing the Socket service.

9.15.8 Socket Client Sends Data via TCP Connection with URCS

The example uses service profile 0 configured for Socket service and TCP.

9.15 Examples of how to Configure and Use Internet Service Profiles

AT^SISO=0	The host opens service profile 0.
OK	
^SISW: 0,1	Socket service is ready for upload.
AT^SISW=0,10	The host requests to write 10 bytes.
^SISW: 0,10,10	Response that 10 bytes can be sent and are unacknowledged.
0123456789	
OK	
^SISW: 0,1	The URC indicates that the Socket service is ready to transfer more data. Data of the last AT^SISW command are transferred to the remote host.
AT^SISW=0,10,1	The host requests to write next 10 bytes and enables the <eodFlag> to notify that these are the last 10 bytes of the session.
^SISW: 0,10,20	Response that the service accepts 10 bytes and this data and the previously sent data are unacknowledged.
0123456789	
OK	
-----	Waiting for URC.
^SISW: 0,2	Data transfer has been finished.
AT^SISC=0	Closing the Socket service.
OK	

9.15.9 UDP Scenario

The following example shows a communication between a UDP endpoint (host 1) and a UDP client (host 2). Part 1 of the example refers to the UDP endpoint and shows the configuration which allows the UDP endpoint to communicate with any UDP client. Part 2 shows the settings of a UDP client. Part 3 and 4 are running in parallel: Part 3 shows the procedures on the UDP endpoint side done when communicating with a UDP client. Part 4 shows the equivalent steps done by the UDP client when communicating with the UDP endpoint.

Part 1 - host 1 is configured for use as UDP endpoint:

AT^SISS=0, srvttype, socket	Select service type Socket.
OK	
AT^SISS=0, conid, 1	Select connection profile 1.
OK	
AT^SISS=0, alphabet, 1	Choose ASCII alphabet.
OK	
AT^SISS=0, address, "sockudp://:6666"	Specify the local UDP port.
OK	

Part 2 - host 2 is configured for use as UDP client:

AT^SISS=1, srvttype, socket	Select service type Socket.
OK	
AT^SISS=1, conid, 1	Select connection profile 1.
OK	
AT^SISS=1, alphabet, 1	Choose ASCII alphabet.
OK	
AT^SISS=1, address, "sockudp://10.10.0.219:6666"	Specify the address of host 1.
OK	

9.15 Examples of how to Configure and Use Internet Service Profiles

Part 3 - host 1 opens the service and communicates with host 2:

AT^SISO=0	Open the service.
OK	
^SIS: 0,5	URC indicates that host 1 is waiting (on UDP port 6666).
AT^SISO=0,1	
^SISO:	Request connection status.
0, "Socket", 4, 3, 0, 0, "10.10.0.219:6666", "0.0.0.0:0"	
OK	
^SISR: 0,1	URC indicates that host 2 has opened the connection to host 1 and has sent some data.
AT^SISR=0,100	Host 1 requests to read 100 bytes.
OK	
^SISR: 0,22, "10.10.0.222:6561"	Host 1 is reading the text string received from host 2 (see part 4 of the example) and gets information about the remote client, i.e. the address of host 2.
Hello, I'm the client!	
OK	
AT^SISW=0,25,0, "10.10.0.222:6561"	Host 1 starts sending 25 bytes to host 2.
^SISW: 0,25,0	Host 1 is sending the message "Hi, I'm the UDP endpoint!" (25 bytes) to host 2. As a result, host 2 is receiving the URC "^SISR: 1,1" shown below in part 4 of the example.
OK	
^SISW: 0,1	URC confirms that host 1 can send data again.
AT^SISC=0	Close the service.
OK	

Part 4 - host 2 opens the service and communicates with host 1:

AT^SISO=1	Open the service.
OK	
^SISW: 1,1	URC indicates that host 2 can send data.
AT^SISO=1,1	
^SISO:	Request connection status.
1, "Socket", 4, 2, 0, 0, "10.10.0.222:6561", "10.10.0.219:6666"	
OK	
AT^SISW=1,22	Host 2 starts to write 22 bytes.
^SISW: 1,22,0	Host 2 is writing the message "Hello, I'm the client!" (22 bytes). As a result, host 1 is receiving the URC "^SISR: 0,1" shown above in part 3 of this example.
OK	
^SISW: 1,1	URC confirms that host 2 could send data.
^SISR: 1,1	URC indicates that host 2 has received data from host 1.
AT^SISR=1,100	Host 2 requests to read 100 bytes.
^SISR: 1,25	Response indicates that host 2 has received 25 characters from host 1.
Hi, I'm the UDP endpoint!	
OK	
AT^SISC=1	Close the service.
OK	

9.15 Examples of how to Configure and Use Internet Service Profiles

9.15.10 Creating Transparent TCP Socket Client

AT^SISS=1, srvType, "Socket"	Select service type "Socket".
OK	
AT^SISS=1, conId, 1	Select connection profile 1.
OK	
AT^SISS=1, address, "socktcp:// 10.10.0.110:9996;etx;timer=200"	Specify server address. Add "etx" parameter to set Transparent mode.
OK	

9.15.11 Opening and Closing Transparent TCP Service

AT^SISO=1	Open Transparent TCP service.
OK	
^SISW: 1,1	URC indicates that Transparent TCP service is ready.
at^sist=1	Open transparent access mode.
CONNECT	Service is ready to send or receive data. Client is sending data, e.g Good Morning (not visible in example).
	Client types +++ to return to AT command mode (+++ not visible in example).
OK	
at^sisi=1	Check the service state of service profile 1.
^SISI: 1,4,0,16,16,0	Service is in state "Up" (4). 0 bytes received, 16 bytes sent and acknowledged.
OK	
AT^SISO?	Check the service state of service profile 1.
^SISO: 0, ""	
^SISO:	Service is in state "Up" (4). Socket is assigned. 0 bytes received, 16 bytes sent. Local and remote IP address are assigned.
1, "Socket", 4, 2, 0, 16, "10.10.0.200:1024", "10. 10.0.108:65532"	
^SISO: 2, ""	
^SISO: 3, ""	
^SISO: 4, ""	
^SISO: 5, ""	
^SISO: 6, ""	
^SISO: 7, ""	
^SISO: 8, ""	
^SISO: 9, ""	
OK	
at^sisi=1	Check the service state of service profile 1.
^SISI: 1,2,0,0,0,0	Service profile 1 is in state "Allocated" (2).
OK	
AT^SISO?	Check the service state of service profile 1.
^SISO: 0, ""	
^SISO:	Service is in state "Allocated" (2). Socket not assigned.
1, "Socket", 2, 1, 0, 0, "0.0.0.0:0", "0.0.0.0:0"	
^SISO: 2, ""	
^SISO: 3, ""	
^SISO: 4, ""	
^SISO: 5, ""	
^SISO: 6, ""	
^SISO: 7, ""	
^SISO: 8, ""	

9.15 Examples of how to Configure and Use Internet Service Profiles

```
^SISO: 9, ""
OK
```

9.15.12 Transparent TCP Client Receives Data While in AT Command Mode

AT^SISO=1	Open Transparent TCP service.
OK	
^SISW: 1,1	URC indicates that Transparent TCP service is ready.
at^sist=1	Open transparent access mode.
CONNECT	Service is ready to send or receive data.
Hello	Client is reading received data.
	Client types +++ to return to AT command mode (+++ not visible in example).
OK	
^SISR: 1,1	URC indicates that new data is available for the client.
at^sist=1	Return to transparent access mode.
CONNECT	Service is ready to send or receive data.
Goodbye	Client is reading received data.
	Client types +++ to return to AT command mode (not visible in example).
OK	
at^sisi=1	Check the service state of service profile 1.
^SISI: 1,4,12,6,6,0	Service is in state "Up" (4). 12 bytes received, 6 bytes sent and acknowledged.
OK	
AT^SISO?	Check the service state of service profile 1.
^SISO: 0, ""	
^SISO:	Service is in state "Up" (4). Socket is assigned. 12 bytes received, 6 bytes sent. Local and remote IP address are assigned.
1, "Socket", 4, 2, 12, 6, "10.10.0.200:1025", "10.10.0.108:65532"	
^SISO: 2, ""	
^SISO: 3, ""	
^SISO: 4, ""	
^SISO: 5, ""	
^SISO: 6, ""	
^SISO: 7, ""	
^SISO: 8, ""	
^SISO: 9, ""	
OK	
AT^SISC=1	Close the service.
OK	
at^sisi=1	Check the service state of service profile 1.
^SISI: 1,2,0,0,0,0	Service profile 1 is in state "Allocated" (2).
OK	
AT^SISO?	Check the service state of service profile 1.
^SISO: 0, ""	
^SISO:	Service is in state "Allocated" (2). Socket not assigned.
1, "Socket", 2, 1, 0, 0, "0.0.0.0:0", "0.0.0.0:0"	
^SISO: 2, ""	
^SISO: 3, ""	
^SISO: 4, ""	
^SISO: 5, ""	

9.15 Examples of how to Configure and Use Internet Service Profiles

```

^SISO: 6, ""
^SISO: 7, ""
^SISO: 8, ""
^SISO: 9, ""
OK

```

9.15.13 Remote Server Disconnects While Transparent TCP Service is in Transparent Access Mode

AT^SISO=1	Open Transparent TCP service.
OK	
^SISW: 1,1	URC indicates that Transparent TCP service is ready.
at^sist=1	Open transparent access mode.
CONNECT	Service is ready to send or receive data.
Good Morning	Remote server has sent data and disconnected. Client reads data. Then client gets NO CARRIER in AT command mode.
NO CARRIER	
at^sisi=1	Check the service state of service profile 1.
^SISI: 1,6,12,0,0,0	Service is in state "Down" (6). 12 bytes received.
OK	
AT^SISO?	Check the service state of service profile 1.
^SISO: 0, ""	
^SISO:	Service is in state "Down" (6). Socket is assigned. 6 bytes received. 12 bytes sent. Local and remote IP address are assigned.
1, "Socket", 6, 2, 12, 0, "10.10.0.200:1026", "10.10.0.108:65532"	
^SISO: 2, ""	
^SISO: 3, ""	
^SISO: 4, ""	
^SISO: 5, ""	
^SISO: 6, ""	
^SISO: 7, ""	
^SISO: 8, ""	
^SISO: 9, ""	
OK	
AT^SISC=1	Close the service.
OK	
at^sisi=1	Check the service state of service profile 1.
^SISI: 1,2,0,0,0,0	Service profile 1 is in state "Allocated" (2).
OK	

9.15.14 Server Disconnects While Transparent TCP Service is in AT Command Mode and Data is Pending

AT^SISO=1	Open Transparent TCP service.
OK	
^SISW: 1,1	URC indicates that Transparent TCP service is ready.
at^sist=1	Open transparent access mode.
CONNECT	Service is ready to send or receive data.
Good Morning	Client is reading data.
	Client types +++ to return to AT command mode (not visible in example).

9.15 Examples of how to Configure and Use Internet Service Profiles

OK	
^SISR: 1,1	Remote server has sent data and closed the connection (not visualized in this example). URC indicates that remaining data is available for reading. Check service state of service profile 1.
at^sisi=1	
OK	
^SISI: 1,4,12,3,3,0	Service profile 1 is in state "Up" (4). 12 bytes received. 3 bytes sent and acknowledged.
OK	
AT^SISO?	Check the service state of service profile 1.
^SISO: 0,""	
^SISO:	Service is in state "Up" (4). Socket is assigned. 12 bytes received. 3 bytes sent. Local and remote IP address are assigned.
1,"Socket",4,2,12,3,"10.10.0.200:1027","10.10.0.108:65532"	
^SISO: 2,""	
^SISO: 3,""	
^SISO: 4,""	
^SISO: 5,""	
^SISO: 6,""	
^SISO: 7,""	
^SISO: 8,""	
^SISO: 9,""	
OK	
at^sist=1	Return to transparent access mode.
CONNECT	Service is ready to send or receive data.
Good bye	Client reads remaining data. Then client gets NO CARRIER in AT command mode.
NO CARRIER	
at^sisi?	Check service state of service profile 1.
^SISI: 1,6,20,3,3,0	Service is in service "Down" state (6). 20 bytes received. 3 bytes sent and acknowledged.
OK	
AT^SISO?	Check the service state of service profile 1.
^SISO: 0,""	
^SISO:	Service is in state "Down" (6). Socket is assigned. 20 bytes received. 3 bytes sent. Local and remote IP address are assigned.
1,"Socket",20,3,"10.10.0.200:1027","10.10.0.108:65532"	
^SISO: 2,""	
^SISO: 3,""	
^SISO: 4,""	
^SISO: 5,""	
^SISO: 6,""	
^SISO: 7,""	
^SISO: 8,""	
^SISO: 9,""	
OK	
AT^SISC=1	Close the service.
OK	
at^sisi=1	Check service state of service profile 1.
^SISI: 1,2,0,0,0,0	Service profile 1 is in state "Allocated" (2).
OK	
AT^SISO?	Check the service state of service profile 1.
^SISO: 0,""	
^SISO:	Service is in state "Allocated" (2). Socket is not assigned. Local and remote IP address not assigned.
1,"Socket",2,1,0,0,"0.0.0.0:0","0.0.0.0:0"	
^SISO: 2,""	
^SISO: 3,""	
^SISO: 4,""	

9.15 Examples of how to Configure and Use Internet Service Profiles

```

^SISO: 5, ""
^SISO: 6, ""
^SISO: 7, ""
^SISO: 8, ""
^SISO: 9, ""
OK

```

9.15.15 FTP Upload Single File (URC Mode)

Configure the service profile 2 for FTP:

AT^SISS=2, "srvType", "Ftp"	Select service type FTP.
OK	
AT^SISS=2, conId, "1"	Select connection profile 1.
OK	
AT^SISS=2, "address", "ftp:// myname:mypasswd@testnetwork/upload"	Specify FTP address with individual user name and password.
OK	
AT^SISS=2, "cmd", "put"	Select command type upload for single file.
OK	
AT^SISS=2, "files", "newdata.txt"	File "newdata.txt" shall be put on FFTP server.
OK	

Make an FTP connection:

AT^SISO=2	Open the service.
OK	Bearer is established, service is getting started.
^SIS: 2,0,2100, "Ftp open(testnetwork:21) "	"^SIS" URC with <urcInfoId> 2100 (FTP) status information from FTP server.
^SIS: 2,0,2100, "220 FTP server (Version 6.4/OpenBSD/Linux-ftpd-0.17) ready."	
^SIS: 2,0,2100, "FTP Login OK"	
^SIS: 2,0,2100, "put newdata.txt"	
^SISW: 2,1	URC indicates that FTP service is ready for upload.
AT^SISW=2,40	Client requests to send 40 bytes.
^SISW: 2,40,0	The write command response confirms that 40 bytes must be transferred now.
01234567890123456789012345678901234567890	User data is transferred.
OK	
^SISW: 2,1	URC indicates that the FTP service is ready to transfer more data.
AT^SISW=2,40	Client requests to send 40 bytes.
^SISW: 2,40,0	The write command response confirms that 40 bytes must be transferred now.
01234567890123456789012345678901234567890	User data is transferred.
OK	
^SISW: 2,1	URC indicates that the FTP service is ready to transfer more data.
AT^SISW=2,0,1	No more data available. <eodFlag> set. File "newdata.txt" shall be closed on FTP server.
^SISW: 2,0,0	
OK	
^SIS: 2,0,2100, "226 Transfer complete."	URC indicates that data transfer finished successfully. Connection to the FTP server closes.
^SISW: 2,2	
AT^SISC=2	Close the FTP service.
OK	

9.15 Examples of how to Configure and Use Internet Service Profiles

9.15.16 HTTP Download Using TLS

Configure the service profile 4 for HTTPS:

AT^SISS=4, srvType, "Http"	Select service type HTTP.
OK	
AT^SISS=4, conId, "1"	Select connection profile 1.
OK	
AT^SISS=4, address, "https://www.facebook.com"	Specify access to Facebook website (always secured).
OK	
AT^SISS=4, cmd, "get"	Select command type download.
OK	

Opening connection:

AT^SISO=4	Open the service.
OK	
^SISS: 4, 0, 2200, "Http www.facebook.com:443"	
^SISR: 4, 1	URC indicates that the HTTP service is ready to read data.
AT^SISR=4, 1000	Read 1000 bytes.
^SISR: 4, 1000	
<?xml version="1.0" encoding="utf-8"?> <!DOCTYPE html PUBLIC "-//WAPFORUM//DTD XHTML Mobile 1.0//EN" "http://www.wapforum.org	
OK	
AT^SISR=4, 1000	Repeat reading data n times.
^SISR: 4, 1000	
...	
^SISR: 4, 2	URC indicates that data transfer finished successfully. Connection to the HTTP server closes.
AT^SISC=4	Close the HTTP service.
OK	

9.15.17 HTTP Post

Configure the service profile 6 for HTTP:

AT^SISS=6, srvType, "Http"	Select service type HTTP.
OK	
AT^SISS=6, conId, "1"	Select connection profile 1.
OK	
AT^SISS=6, "address", "http://testnetwork/cgi/first.pl"	Specify URL.
OK	
AT^SISS=6, "user", "myuser"	Specify user name.
OK	
AT^SISS=6, "passwd", "mypasswd"	Specify password.
OK	
AT^SISS=6, cmd, "post"	Select command type download.
OK	
AT^SISS=6, "hcContent", " "	Parameter is ignored.
OK	

9.15 Examples of how to Configure and Use Internet Service Profiles

```
AT^SISS=6,"hcContLen","2"
OK
```

"hcContlen" greater than "0". Data will be sent from AT command interface.

Opening connection:

```
AT^SISO=6
OK
^SISS: 6,0,2200,"Http pegasus.testnetz.sw5:80"

^SISW: 6,1
AT^SISW=6,30
^SISW: 6,30,0
OK
^SISW: 6,1
AT^SISW=6,30
^SISW: 6,30,0
OK
^SISW: 6,1
AT^SISW=6,0,1
^SISW: 6,0,0
OK
^SISW: 6,2
OK
^SIS: 6,0,2200,"HTTP POST: http://testnetwork/cgi/first.pl"

6,0,2200,"HTTP POST Response: 200"
^SISR: 6,1
^SISR: 6,500
^SISR: 6,197
Hello ..... Goodbye
OK
^SISR: 6,1
AT^SISC=6
OK
```

Open the service.

URC indicates that the HTTP service is ready to send data.
Send 30 bytes.

URC indicates that the HTTP service is ready to send data.
Send 30 bytes.

URC indicates that the HTTP service is ready to send data.
Finish input by setting `<eodFlag>` and start HTTP POST request.

URC confirms: all data sent to server.

Read response from server.
Read 500 bytes.
Reading 197 bytes.

All data read.
Close the HTTP service.

9.15.18 Ping

This example shows a Ping output. The example uses the Internet connection profile shown in Section 9.15.2.

```
AT^SISX=Ping,1,"74.125.39.99",5,5000
^SISX: "Ping",1,1,"74.125.39.99",1696
^SISX: "Ping",1,1,"74.125.39.99",175
^SISX: "Ping",1,1,"74.125.39.99",174
^SISX: "Ping",1,1,"74.125.39.99",174
^SISX: "Ping",1,1,"74.125.39.99",2111
^SISX: "Ping",2,1,5,5,0,0
^SISX: "Ping",3,1,174,2111,865
OK
```

9.15.19 Resolving DNS Host Name to IP Address

This example uses the Internet connection profile shown in Section [9.15.2](#).

```
AT^SISX=HostByName,1,"www.google.de"  
^SISX: "HostByName", "74.125.39.99"  
OK
```

10. Packet Domain Related Commands

The AT commands described in this chapter allow the Customer Application to control packet switched services in networks.

10.1 AT+CGACT PDP context activate or deactivate

The `AT+CGACT` write command is used to activate or deactivate the specified PDP context(s). After the command has completed, the MT remains in V.250 command state. If any PDP context is already in the requested state, the state for that context remains unchanged. If the MT is not PS attached when the activation form of the command is executed, the MT first performs a PS attach and then attempts to activate the specified contexts.

If no `<cid>`s are specified the activation/deactivation form of the command activates/deactivates all defined contexts.

For EPS, if an attempt is made to disconnect the last PDN connection, then the MT responds with ERROR or, if extended error responses are enabled, a +CME ERROR. For EPS, the activation request for an EPS bearer resource will be answered by the network by either an EPS dedicated bearer activation or EPS bearer modification request. The request must be accepted by the MT before the PDP context can be set into established state.

The `AT+CGACT` read command returns the current activation states for all the defined PDP contexts.

The `AT+CGACT` test command is used for requesting information on the supported PDP context activation states.

Syntax

Test Command

```
AT+CGACT=?
```

```
Response(s)
```

```
+CGACT: (list of supported <state>s)
```

```
OK
```

Read Command

```
AT+CGACT?
```

```
Response(s)
```

```
+CGACT: [<cid>, <state>]
```

```
[+CGACT: <cid>, <state>]
```

```
...
```

```
OK
```

Write Command

```
AT+CGACT=<state>[, <cid>[, <cid>]]
```

```
Response(s)
```

```
+CGACT: [<cid>, <state>]
```

```
[+CGACT: <cid>, <state>]
```

```
...
```

```
OK
```

```
ERROR
```

```
+CME ERROR: <err>
```

```
PIN → Last
```

```
+ + -
```

```
Reference(s)
```

```
3GPP TS 27.007 [39]
```

Parameter Description

`<state>`^(num)

Indicates the state of PDP context activation.

0	Detached
[1]	Attached

`<cid>`^(num)

Parameter specifies a particular PDP context definition (see [AT+CGDCONT](#) parameter `<cid>`). The parameter is used in other PDP context-related commands.

Notes

- A maximum of 8 contexts can be activated at the same time, no matter on which interface. Note that, depending on the provider, the number of activated contexts may be further restricted. In particular, `<cid>=8` is reserved for emergency PDN and cannot be used.
- On Verizon Wireless network, there are only four PDN defined by default.
 - PDP context 1: `<PDP_type>="IPV4V6"`, `<APN>="VZWIMS"`.
 - PDP context 2: `<PDP_type>="IPV4V6"`, `<APN>="VZWADMIN"`.
 - PDP context 3: `<PDP_type>="IPV4V6"`, `<APN>="VZWINTERNET"`.
 - PDP context 4: `<PDP_type>="IPV4V6"`, `<APN>="VZWAPP"`.Therefore, it is only possible to activate `<cid>` 1 to 4, and it is not possible to activate `<cid>` 5 to 8.
- If activation or deactivation of a context fails, then [AT+CEER](#) may provide further informations about the reason.

10.2 AT+CGATT GPRS attach or detach

The **AT+CGATT** write command is used to attach the MT to, or detach the MT from the Packet Domain service. After the command has completed, the MT remains in V.250 command state. If the MT is already in the requested state, the command is ignored and the OK response is returned. Any active PDP contexts will be automatically deactivated when the attachment state changes to detached.

The **AT+CGATT** read command returns the current Packet Domain service state.

The **AT+CGATT** test command is used for requesting information on the supported Packet Domain service states.

Syntax

Test Command	
AT+CGATT=?	
Response(s)	
+CGATT: (list of supported <state>s)	
OK	
Read Command	
AT+CGATT?	
Response(s)	
+CGATT: <state>	
OK	
Write Command	
AT+CGATT=[<state>]	
Response(s)	
OK	
ERROR	
+CME ERROR: <err>	
PIN → Last	Reference(s)
+ - -	3GPP TS 27.007 [39]

Parameter Description

<state> ^(num)	
Indicates the state of Packet Domain attachment. The parameter is global for all interfaces.	
0 ^(P)	Detached
[1]	Attached

10.3 AT+CGDCONT Define PDP Context

The `AT+CGDCONT` write command specifies the parameters for a PDP context identified by the context identifier `<cid>`. The number of contexts that may be in a defined state at the same time is given by the range indicated in the test command response. A special form of the write command (`AT+CGDCONT=<cid>`) causes the values for context `<cid>` to become undefined.

The `AT+CGDCONT` read command returns the current settings for each defined PDP context.

The `AT+CGDCONT` test command returns supported values as a compound value.

NOTE: According to Verizon Wireless requirements, it is not allowed to change the definition of any PDN. The only exception is the Internet PDN for which the APN can be changed. See `AT+CGACT` for details on Verizon Wireless requirements for dedicated PDP contexts.

Syntax

Test Command

AT+CGDCONT=?

Response(s)

```
+CGDCONT: (range of supported <cid>s), "IP", , , , (list of supported <IPv4AddrAlloc>s), (list of supported <emergency_indication>s), (list of supported <P-CSCF_discovery>s), (list of supported <IM_CN_Signalling_Flag_Ind>s), (list of supported <NSLPI>s)
+CGDCONT: (range of supported <cid>s), "IPV6", , , , (list of supported <emergency_indication>s), (list of supported <P-CSCF_discovery>s), (list of supported <IM_CN_Signalling_Flag_Ind>s), (list of supported <NSLPI>s)
+CGDCONT: (range of supported <cid>s), "IPV4V6", , , , (list of supported <IPv4AddrAlloc>s), (list of supported <emergency_indication>s), (list of supported <P-CSCF_discovery>s), (list of supported <IM_CN_Signalling_Flag_Ind>s), (list of supported <NSLPI>s)
OK
ERROR
+CME ERROR: <err>
```

Read Command

AT+CGDCONT?

Response(s)

```
[+CGDCONT: <cid>, "IP", <APN>, <PDP_addr>, , [, <IPv4AddrAlloc>[, <emergency_indication>[, <P-CSCF_discovery>[, <IM_CN_Signalling_Flag_Ind>[, <NSLPI>]]]]]]
[+CGDCONT: <cid>, "IPV6", <APN>, <PDP_addr>, , [, [, <emergency_indication>[, <P-CSCF_discovery>[, <IM_CN_Signalling_Flag_Ind>[, <NSLPI>]]]]]]
[+CGDCONT: <cid>, "IPV4V6", <APN>, <PDP_addr>, , [, <IPv4AddrAlloc>[, <emergency_indication>[, <P-CSCF_discovery>[, <IM_CN_Signalling_Flag_Ind>[, <NSLPI>]]]]]]
[+CGDCONT: ...]
OK
ERROR
+CME ERROR: <err>
```

Write Command

AT+CGDCONT=[<cid>[, <PDP_type>[, <APN>[, <PDP_addr>[, <d_comp>[, <h_comp>]]], <IPv4AddrAlloc>[, <emergency_indication>[, <P-CSCF_discovery>[, <IM_CN_Signalling_Flag_Ind>[, <NSLPI>]]]]]]]]

Response(s)

```
OK
ERROR
+CME ERROR: <err>
```

PIN → Last

- + -

Reference(s)

3GPP TS 27.007 [39]

Parameter Description

<cid>^{(num)(NV)}

PDP Context Identifier

Parameter specifies a particular PDP context definition. The parameter is used in other PDP context-related commands. The range of the permitted values for <cid> is given by the [AT+CGDCONT](#) test command. <cid>=8 is reserved for emergency PDN and cannot be used.

1...8

<PDP_type>^{(str)(NV)}

Packet Data Protocol type

Specifies the type of the packet data protocol.

“IP” Internet Protocol (IETF STD 5)

“IPV6” Internet Protocol, version 6 (see RFC 2460)

“IPV4V6” Virtual <PDP_type> introduced to handle dual IP stack UE capability. (See 3GPP TS 24.301).

<APN>^{(str)(NV)}

Access Point Name

The logical name that is used to select the GGSN or the external packet data network. Maximum length: 100 characters.

An Access Point Name has to follow the syntax rules specified in 3GPP TS 23.003 in section 9.1.

If the value is null or omitted, then the subscription value will be requested.

<PDP_addr>^{(str)(NV)}

Packet Data Protocol address

Identifies the MT in the address space applicable to PDP (e.g. IP V4 address for PDP type IP). If the value is null or omitted, then a value may be provided by the TE during the PDP startup procedure or, failing that, a dynamic address will be requested. The read command will continue to return the null string even if an address has been allocated during the PDP startup procedure. The allocated address may be read using [AT+CGPADDR](#).

<d_comp>^{(num)(NV)}

Data Compression

Controls the PDP data compression (applicable for Subnetwork Dependent Convergence Protocol (SNDCP) only); see 3GPP TS 44.065 for details.

Note: This parameter is not supported.

<h_comp>^{(num)(NV)}

Header Compression

Controls the PDP header compression; see 3GPP TS 44.065, 3GPP TS 25.323 for details.

Note: This parameter is not supported.

<IPv4AddrAlloc>^(num)

Numeric parameter that controls how the MT/TA requests to get the IPv4 address information.

0 IPv4 Address Allocation through NAS Signalling

1 IPv4 Address Allocated through DHCP

<emergency_indication>^(num)

Numeric parameter used to indicate whether the PDP context is for emergency bearer services or not.

- | | |
|---|--|
| 0 | PDP context is not for emergency bearer services |
| 1 | PDP context is for emergency bearer services |

<P-CSCF_discovery>^(num)

Numeric parameter influences how the MT/TA requests to get the P-CSCF address, see 3GPP TS 24.229 [89] annex B and annex L.

- | | |
|---|---|
| 0 | Preference of P-CSCF address discovery not influenced by +CGDCONT |
| 1 | Preference of P-CSCF address discovery through NAS Signalling |

<IM_CN_Signalling_Flag_Ind>^(num)

Numeric parameter used to indicate to the network whether the PDP context is for IM CN subsystem-related signalling only or not.

- | | |
|---|---|
| 0 | UE indicates that the PDP context is not for IM CN subsystem-related signaling only |
| 1 | UE indicates that the PDP context is for IM CN subsystem-related signaling only |

<NSLPI>^(num)

Numeric parameter used to indicate the NAS signalling priority requested for this PDP context.

- | | |
|---|--|
| 0 | Indicates that this PDP context is to be activated with the value for the low priority indicator configured in the MT. |
| 1 | Indicates that this PDP context is is to be activated with the value for the low priority indicator set to "MS is not configured for NAS signalling low priority". |

10.3.1 Attaching to LTE Networks

To allow access to the PS domain, the UE has to perform the attach and context activation procedure. During the context activation procedure, the access point name (APN) specifies the selected packet data network to which the context will be established.

In contrast to 2G (GSM) and 3G (UMTS) where attach and context activation are performed separately, the LTE attach procedure always includes the automatic activation of one context (either using the default bearer or the APN specified for <cid> 1). Therefore, the UE automatically tries to attach to LTE after the SIM PIN1 is unlocked, the application shall ensure that the correct APN is specified *before* the UE attaches to LTE.

LTE attach with no APN

If no APN is specified for <cid> 1 when the UE attaches to LTE, the network will automatically select the so called default APN, specified in the HSS, to establish the initial context (PDN connection/default bearer). Although the LTE attach procedure will be successful in that case, the context for the default APN might be configured with restrictions concerning the transmission of data, depending on the operator settings.

LTE attach with wrong APN

If a wrong APN is configured for <cid> 1 during the LTE attach procedure, e.g. if an application allows the user to change SIM cards and the APN was not set correctly after the SIM change, the LTE attach will be rejected by the network. As result, the RAT type LTE will be disabled by the UE for a limited amount of time and the UE will only use 2G and 3G RAT types for PS access. The duration while RAT type LTE is disabled depends on network configuration (timer T3402, default 12 minutes).

10.4 AT+CGDSCONT Define Secondary PDP Context

The [AT+CGDSCONT](#) write command specifies PDP context parameter values for a Secondary PDP context identified by the (local) context identification parameter `<cid>`. The number of PDP contexts that may be in a defined state at the same time is given by the range returned by the test command.

A special form of the write command, [AT+CGDSCONT=<cid>](#) causes the values for context number `<cid>` to become undefined. The [AT+CGDSCONT](#) read command returns the current settings for each defined secondary context.

The [AT+CGDSCONT](#) test command returns values supported as a compound value.

Syntax

<p>Test Command</p> <pre>AT+CGDSCONT=?</pre> <p>Response(s)</p> <pre>+CGDSCONT: (range of supported <cid>s), (list of <pcid>s for defined primary contexts), (list of supported <d_comp>s), (list of supported <h_comp>s), (list of supported <IM_CN_Signalling_Flag_Ind>s) OK ERROR +CME ERROR: <err></pre>	
<p>Read Command</p> <pre>AT+CGDSCONT?</pre> <p>Response(s)</p> <pre>+CGDSCONT: [<cid>, <pcid>, <d_comp>, <h_comp>], <IM_CN_Signalling_Flag_Ind> [+CGDSCONT: <cid>, <pcid>, <d_comp>, <h_comp>, <IM_CN_Signalling_Flag_Ind>] [+CGDSCONT: ...] OK ERROR +CME ERROR: <err></pre>	
<p>Write Command</p> <pre>AT+CGDSCONT=<cid>[, <pcid>[, <d_comp>[, <h_comp>, <IM_CN_Signalling_Flag_Ind>]]]</pre> <p>Response(s)</p> <pre>OK ERROR +CME ERROR: <err></pre>	
<p>PIN → Last</p> <p>- + -</p>	<p>Reference(s)</p> <p>3GPP TS 27.007 [39]</p>

Parameter Description

`<cid>`^{(num)(NV)}

PDP Context Identifier

Parameter specifies a particular PDP context definition and is used in other PDP context-related commands.

1...8

`<pcid>`^{(num)(NV)}

Primary PDP Context Identifier

Parameter specifies a particular PDP context definition which has been specified by use of the [AT+CGDSCONT](#) command. The list of permitted values is returned by the test form of the command.

1...8

<d_comp>^{(num)(NV)}

Data Compression

Controls the PDP data compression (applicable for Subnetwork Dependent Convergence Protocol (SNDCP) only) 3GPP TS 44.065

[0] off

<h_comp>^{(num)(NV)}

Header Compression

Controls the PDP header compression 3GPP TS 44.065, 3GPP TS 25.323

[0] off

<IM_CN_Signalling_Flag_Ind>^{(num)(NV)}

IM CN Signalling Flag

Indicates to the network whether the PDP context is for IM CN subsystem-related signalling only or not.

0 PDP context is not for IM CN subsystem-related signalling only.

1 PDP context is for IM CN subsystem-related signalling only.

Note

- According to Verizon Wireless requirements, ELS31-V is forbidden to open any dedicated bearer.

10.5 AT+CGCMOD PDP Context Modify

The [AT+CGCMOD](#) write command can be used to modify the specified PDP context(s) with respect to QoS profiles and TFTs. If no `<cid>`s are specified then all active contexts will be modified. If modification of a context fails, then [AT+CEER](#) may provide further informations about the reason.

The [AT+CGCMOD](#) test command returns a list of `<cid>`s associated with active contexts which could be modified.

NOTE: According to Verizon Wireless requirements, it is not allowed to change any PDP context with respect to QoS profile and TFTs. Therefore, the [AT+CGCMOD](#) write command is dummy and always returns OK.

Syntax

Test Command	
AT+CGCMOD=?	
Response(s)	
+CGCMOD: (list of <code><cid></code> s associated with active contexts)	
OK	
ERROR	
+CME ERROR: <code><err></code>	
Write Command	
AT+CGCMOD=[<code><cid></code> [, <code><cid></code>]]	
Response(s)	
OK	
ERROR	
+CME ERROR: <code><err></code>	
PIN → Last	Reference(s)
+ - -	3GPP TS 27.007 [39]

Parameter Description

<code><cid></code> ^(num)
Parameter specifies a particular PDP context definition (see AT+CGDCONT parameter <code><cid></code>).

10.6 AT+CEREG EPS Network Registration Status

AT+CEREG write command enables presentation of URC "+CEREG: <stat>" when <n>=1 and UE's EPS network registration status in LTE changes, or URC "+CEREG: <stat>[, <tac>][, <ci>][, <AcT>]" when <n>=2 and the current network cell in LTE changes.

AT+CEREG read command queries the current URC presentation status and <stat> which shows whether the network has currently indicated the registration of the ME. Location information elements <tac> and <ci> are returned only if <n>=2 and ME is registered to the network.

Syntax

<p>Test Command</p> <pre>AT+CEREG=?</pre> <p>Response(s)</p> <pre>+CEREG: (list of supported <n>s) OK</pre>	
<p>Read Command</p> <pre>AT+CEREG?</pre> <p>Response(s)</p> <pre>+CEREG: <n>, <stat>[, <tac>][, <ci>][, <AcT>] OK</pre>	
<p>Write Command</p> <pre>AT+CEREG=<n></pre> <p>Response(s)</p> <pre>OK ERROR +CME ERROR: <err></pre>	
<p>PIN → Last</p> <pre>+ + -</pre>	<p>Reference(s)</p> <p>3GPP TS 27.007 [39]</p>

Unsolicited Result Codes

URC 1

```
+CEREG: <stat>
```

Indicates a change in the UE's EPS network registration status.

URC 2

```
+CEREG: <stat>[, <tac>][, <ci>][, <AcT>]
```

Indicates a change in the UE's EPS network registration status or a change of the network cell including location information.

Parameter Description

<n> ^{(num)(&V)(&W)}	
0 ^{(&F)(D)}	Disable network registration unsolicited result code
1	Enable network registration URC "+CEREG: <stat>"
2	Enable network registration URC "+CEREG: <stat>[, <tac>][, <ci>][, <AcT>]"

<stat>^(num)

0	Not registered, ME is not currently searching an operator to register to.
1	Registered, home network.
2	Not registered, but ME is currently trying to attach or searching an operator to register to.
3	Registration denied.
4	Unknown, e.g. out of LTE coverage
5	Registered, roaming.

<tac>^(str)

Two byte tracking area code in hexadecimal format (e.g. "00C3" equals 195 in decimal)

<ci>^(str)

Four byte LTE cell ID in hexadecimal format.

<AcT>^(num)

Radio access technology

0	GSM (not applicable)
2	UTRAN (not applicable)
3	GSM w/EGPRS (not applicable)
4	UTRAN w/HSDPA (not applicable)
5	UTRAN w/HSUPA (not applicable)
6	UTRAN w/HSDPA and w/HSUPA (not applicable)
7	E-UTRAN

10.7 AT+CGEREP Packet Domain Event Reporting

The `AT+CGEREP` write command enables or disables sending of unsolicited result codes, +CGEV URCs from MT to TE in the case of certain events occurring in the Packet Domain MT or the network.

Parameter `<mode>` controls the processing of unsolicited result codes specified within this command. `<bfr>` controls the effect on buffered codes when `<mode>` 1 or 2 is entered. If a setting is not supported by the MT, ERROR or +CME ERROR: is returned.

The `AT+CGEREP` read command returns the current `<mode>` and buffer settings.

The `AT+CGEREP` test command returns the modes and buffer settings supported by the MT as compound values.

Syntax

<p>Test Command</p> <pre>AT+CGEREP=?</pre> <p>Response(s)</p> <pre>+CGEREP: (list of supported <mode>s), (list of supported <bfr>s) OK</pre>	
<p>Read Command</p> <pre>AT+CGEREP?</pre> <p>Response(s)</p> <pre>+CGEREP: <mode>, <bfr> OK</pre>	
<p>Write Command</p> <pre>AT+CGEREP=[<mode>[, <bfr>]]</pre> <p>Response(s)</p> <pre>OK ERROR +CME ERROR: <err></pre>	
<p>PIN → Last</p> <pre>+ + -</pre>	<p>Reference(s)</p> <p>3GPP TS 27.007 [39]</p>

Unsolicited Result Codes

URC 1

```
+CGEV: NW DEACT <pcid>, <cid>, <event-type>
```

The network has deactivated a context. The `<cid>` for this context is provided to the TE in addition to the associated primary `<pcid>`. The formats of the parameters `<pcid>` and `<cid>` are found in commands `AT+CGDCONT` and `AT+CGDSCONT`.

URC 2

```
+CGEV: ME DEACT <pcid>, <cid>, <event-type>
```

The network has responded to an ME initiated context deactivation request. The associated `<cid>` is provided to the TE in addition to the associated primary `<pcid>`. The format of the parameters `<pcid>` and `<cid>` are found in command `AT+CGDSCONT`.

URC 3

```
+CGEV: NW DETACH
```

The network has forced a PS detach.

URC 4

+CGEV: ME DETACH

The mobile equipment has forced a PS detach.

URC 5

+CGEV: PDN DEACT <cid>

A context deactivation has been forced. The <cid> that was used to activate the context is provided if known to the MT. The context represents a PDN connection in LTE.

URC 6

+CGEV: ME ACT <pcid>, <cid>, <event-type>

The network has responded to an ME initiated context activation. The <cid> for this context is provided to the TE in addition to the associated primary <pcid>.

URC 7

+CGEV: NW MODIFY <cid>, <change-reason>, <event-type>

The network has modified a context. The associated <cid> is provided to the TE in addition to the <change-reason> and <event-type>. The format of the parameter <cid> is found in command [AT+CGDCONT](#) or [AT+CGDSCONT](#).

URC 8

+CGEV: NW PDN ACT <cid>

The network has activated a context. The context represents a Primary PDP context in. The <cid> for this context is provided to the TE. The format of the parameter <cid> is found in command [AT+CGDCONT](#).

URC 9

+CGEV: NW PDN DEACT <cid>

The network has deactivated a context. The context represents a PDN connection in LTE or a Primary PDP context in. The associated <cid> for this context is provided to the TE. The format of the parameter <cid> is found in command [AT+CGDCONT](#).

URC 10

+CGEV: ME PDN DEACT <cid>

The mobile termination has deactivated a context. The context represents a PDN connection in LTE or a Primary PDP context in. The <cid> for this context is provided to the TE. The format of the parameter <cid> is found in command [AT+CGDCONT](#).

URC 11

+CGEV: NW ACT <pcid>, <cid>, <event-type>

The network has activated a context. The <cid> for this context is provided to the TE in addition to the associated primary <pcid>. The format of the parameters <pcid> and <cid> are found in command [AT+CGDSCONT](#).

URC 12

+CGEV: ME MODIFY <cid>, <change-reason>, <event-type>

The mobile termination has modified a context. The associated <cid> is provided to the TE in addition to the <change-reason> and <event-type>.

URC 13

+CGEV: ME PDN ACT <cid>[, <reason>]

The UE has activated a context. The context represents a Primary PDP context in LTE. The <cid> for this context is provided to the TE. This event is sent either in result of explicit context activation request ([AT+CGACT](#)), or in result of implicit context activation request associated to attach request ([AT+CGATT=1](#)).

Parameter Description

<mode>^(num)

0 ^(P)	Buffer unsolicited result codes in the MT. Currently 3 +CGEV URCs can be buffered. If MT result code buffer is full, the oldest ones will be discarded. No codes are forwarded to the TE.
1	Discard unsolicited result codes when MT TE link is reserved (e.g. in on line data mode); otherwise forward them directly to the TE.
2	Buffer unsolicited result codes in the MT when MT TE link is reserved (e.g. in on line data mode) and flush them to the TE when MT TE link becomes available; otherwise forward them directly to the TE. Currently 3 +CGEV URCs can be buffered. If MT result code buffer is full, the oldest URCs will be discarded.

<bfr>^(num)

0	MT buffer of unsolicited result codes defined within this command is cleared when <mode> 1 or 2 is entered
1	MT buffer of unsolicited result codes defined within this command is flushed to the TE when <mode> 1 or 2 is entered (OK response will be given before flushing the codes). Buffer is empty afterwards.

<reason>^(num)

Indicates the reason why the context activation request for PDP type IPv4v6 was not granted. This parameter is only included if the requested PDP type associated with <cid> is IPv4v6, and the PDP type assigned by the network for <cid> is either IPv4 or IPv6.

0	IPV4 only allowed
1	IPV6 only allowed
2	Single address bearers only allowed
3	Single address bearers only allowed and MT initiated context activation for a second address type bearer was not successful.

<change-reason>^(num)

Integer type parameter indicates what kind of change occurred.

0	Not available
1	TFT only changed
2	Qos only changed
3	Both TFT and QoS changed

<event-type>^(num)

Integer type parameter indicates whether this is an informational event or whether the TE has to acknowledge it.

0	Informational event
---	---------------------

10.8 AT+CGPADDR Show PDP Address

The [AT+CGPADDR](#) exec command returns a list of PDP addresses for all defined contexts.

The [AT+CGPADDR](#) write command returns a list of PDP addresses for the specified context identifiers. If a context is not defined, then no output line is generated for it. If no `<cid>` is specified, the addresses for all defined contexts are returned.

The [AT+CGPADDR](#) test command returns a list of defined `<cid>`s.

Syntax

<p>Test Command</p> <pre>AT+CGPADDR=?</pre> <p>Response(s)</p> <pre>[+CGPADDR: (list of defined <cid>s)] OK</pre>	
<p>Exec Command</p> <pre>AT+CGPADDR</pre> <p>Response(s)</p> <pre>[+CGPADDR: <cid>[, <PDP_address_1>[, <PDP_address_2>]]] [+CGPADDR: ...] OK ERROR +CME ERROR: <err></pre>	
<p>Write Command</p> <pre>AT+CGPADDR=[<cid>[,<cid>[, ...]]]</pre> <p>Response(s)</p> <pre>[+CGPADDR: <cid>[, <PDP_address_1>[, <PDP_address_2>]]] [+CGPADDR: ...] OK ERROR +CME ERROR: <err></pre>	
<p>PIN → Last</p> <pre>+ + -</pre>	<p>Reference(s)</p> <p>3GPP 27.007</p>

Parameter Description

`<cid>`^(num)

Parameter specifies a particular PDP context definition (see [AT+CGDCONT](#) parameter `<cid>`).

`<PDP_address_1>`^(str)

A string that identifies the MT in the address space applicable to the PDP. The address may be static or dynamic. If address is not available parameter is omitted.

Parameter specifies the assigned address as a dot-separated numeric (0-255) parameter of the form "a1.a2.a3.a4" for IPv4 and "a1.a2.a3.a4.a5.a6.a7.a8.a9.a10.a11.a12.a13.a14.a15.a16" for IPv6.

The settings of [AT+CGPIAF](#) can influence the format of the IPv6 address.

<PDP_address_2>^(str)

A string that identifies the MT in the address space applicable to the PDP. The address may be static or dynamic. Parameter is displayed only when both IPv4 and IPv6 addresses are assigned, with <PDP_address_1> containing the IPv4 address and this parameter the IPv6 address.

Parameter specifies the assigned IPv6 address as a dot-separated numeric (0-255) parameter of the form "a1.a2.a3.a4.a5.a6.a7.a8.a9.a10.a11.a12.a13.a14.a15.a16".

The settings of [AT+CGPIAF](#) can influence the format of this parameter.

10.9 AT+CGPIAF Select Printing IP address format

AT+CGPIAF specifies the format to print IPV6 address parameters of other AT commands. See RFC 4291 for details of the IPv6 address format. The +CGPIAF parameters <format>, <subnet>, <lzeros> and <czeros> affect the following commands and parameters:

- in AT+CGTFT and AT+CGTFTRDP, the <rem_addr_subnet_mask>;
- in AT+CGDCONT, the <PDP_addr>;
- in AT+CGPADDR, the <PDP_address_1> and <PDP_address_2>;
- in AT+CGCONTRDP, the <LocalAddr and SubNetMask>, <DNS_prim_addr> and <DNS_sec_addr>.

The read command returns the current command parameter settings.
 The test command returns supported parameter values.

Syntax

<p>Test Command</p> <pre>AT+CGPIAF=?</pre> <p>Response(s)</p> <pre>+CGPIAF: (list of supported <format>s), (list of supported <subnet>s), (list of supported <lzeros>s), (list of supported <czeros>s)</pre> <p>OK</p>	
<p>Read Command</p> <pre>AT+CGPIAF?</pre> <p>Response(s)</p> <pre>+CGPIAF: <format>, <subnet>, <lzeros>, <czeros></pre> <p>OK</p>	
<p>Write Command</p> <pre>AT+CGPIAF=[<format>[, <subnet>[, <lzeros>[, <czeros>]]]]</pre> <p>Response(s)</p> <pre>OK ERROR +CME ERROR: <err></pre>	
<p>PIN → Last</p> <pre>+ + -</pre>	<p>Reference(s)</p> <pre>3GPP 27.007</pre>

Parameter Description

<format> ^(num)	
A numeric parameter which decides the IPv6 address format. Relevant for all AT command parameters that can hold an IPv6 address.	
0 ^(P)	Use IPv4-like dot-notation. IP address, and subnetwork mask if applicable, are dot-separated, e.g. "32.1.13.184.0.0.205.48.0.0.0.0.0.0.0.0.255.255.255.255.255.255.240.0.0.0.0.0.0" for parameters holding address and subnet mask and "32.1.13.184.0.0.205.48.0.0.0.0.0.0.0" for other IP address parameters.

1 Use IPv6-like colon-notation. IP address, and subnetwork mask if applicable and when given explicitly, are separated by a space, e.g.
"2001:0DB8:0000:CD30:0000:0000:0000:0000
FFFF:FFFF:FFFF:FFF0:0000:0000:0000:0000"
for parameters holding address and subnet mask and
"2001:0DB8:0000:CD30:0000:0000:0000:0000"
for other IP address parameters.

<subnet>^(num)

A numeric parameter which decides the subnet-notation for parameters that hold remote address and subnet mask, e.g. <rem_addr_subnet_mask>. Setting does not apply if <format>= 0.

0^(P) Both IP Address and subnet mask are stated explicitly, separated by a space, e.g.
"2001:0DB8:0000:CD30:0000:0000:0000:0000
FFFF:FFFF:FFFF:FFF0:0000:0000:0000:0000".
1 The printout format is applying / (forward slash) subnet-prefix Classless Inter-Domain Routing (CIDR) notation, e.g.
":0DB8:0000:CD30:0000:0000:0000:0000/60"

<lzeros>^(num)

A numeric parameter which decides whether leading zeros are omitted or not. Setting does not apply if <format>= 0.

0^(P) Leading zeros are omitted, e.g. "2001:DB8:0:CD30:0:0:0:0".
1 Leading zeros are included, e.g.
"2001:0DB8:0000:CD30:0000:0000:0000:0000".

<czeros>^(num)

A numeric parameter which decides whether 1-n instances of 16-bit zero-values are replaced by only '::'. This applies only once. Setting does not apply if <format>= 0.

0^(P) No zero compression, e.g. "2001:DB8:0:CD30:0:0:0:0".
1 Use zero compression, e.g. "2001:DB8:0:CD30::".

10.10 AT+CGEQOS Define EPS Quality of Service

The write command allows the UE to specify the EPS Quality of Service parameters for a PDP context or Traffic Flows. When in UMTS/GPRS the MT applies a mapping function to UMTS/GPRS Quality of Service. A special form of the write command, `AT+CGEQOS=<cid>`, causes the values for context number `<cid>` to become undefined.

Syntax

<p>Test Command</p> <pre>AT+CGEQOS=?</pre> <p>Response(s)</p> <pre>+CGEQOS: (range of supported <cid>s), (list of supported <QCI>s), (list of supported <DL_GBR>s), (list of supported <UL_GBR>s), (list of supported <DL_MBR>s), (list of supported <UL_MBR>s) OK</pre>	
<p>Read Command</p> <pre>AT+CGEQOS?</pre> <p>Response(s)</p> <pre>[+CGEQOS: <cid>, <QCI>, [<DL_GBR>, <UL_GBR>], [<DL_MBR>, <UL_MBR>]] [+CGEQOS: ...] OK</pre>	
<p>Write Command</p> <pre>AT+CGEQOS=<cid>[, <QCI>[, <DL_GBR>, <UL_GBR>[, <DL_MBR>, <UL_MBR>]]]</pre> <p>Response(s)</p> <pre>OK ERROR +CME ERROR: <err></pre>	
<p>PIN → Last</p> <p>- + -</p>	<p>Reference(s)</p> <p>3GPP TS 27.007 [39]</p>

Parameter Description

<p><code><cid></code>^(num)</p> <p>Specifies a particular EPS Traffic Flows definition in EPS and a PDP Context definition in UMTS/GPRS (see AT+CGDCONT and AT+CGDSCONT).</p> <p>1...8</p>
<p><code><QCI></code>^(num)</p> <p>Specifies a class of EPS QoS.</p> <p>0 QCI is selected by network</p> <p>1...4 Value range for guaranteed bit rate Traffic Flows</p> <p>5...9 Value range for non-guaranteed bit rate Traffic Flows</p>
<p><code><DL_GBR></code>^(num)</p> <p>Indicates DL GBR in case of GBR QCI. The value is in kbit/s. This parameter is omitted for a non-GBR QCI (see 3GPP TS 24.301 [35]).</p>

<UL_GBR>^(num)

Indicates UL GBR in case of GBR QCI. The value is in kbit/s. This parameter is omitted for a non-GBR QCI (see 3GPP TS 24.301 [35]).

<DL_MBR>^(num)

Indicates DL MBR in case of GBR QCI. The value is in kbit/s. This parameter is omitted for a non-GBR QCI (see 3GPP TS 24.301 [35]).

<UL_MBR>^(num)

Indicates UL MBR in case of GBR QCI. The value is in kbit/s. This parameter is omitted for a non-GBR QCI (see 3GPP TS 24.301 [35]).

10.11 AT+CGEQOSRDP EPS Quality of Service Read Dynamic Parameters

The write command returns Quality of Service parameters of the active PDP context associated to the provided context identifier `<cid>`.

If the parameter `<cid>` is omitted, the Quality of Service parameters for all secondary and non-secondary active PDP contexts are returned.

The test command returns a list of `<cid>`s associated with active PDP contexts. Parameters of both network and MT/TA initiated PDP contexts will be returned.

Syntax

Test Command AT+CGEQOSRDP=? Response(s) +CGEQOSRDP: (list of <code><cid></code> s associated with active contexts) OK	
Write Command AT+CGEQOSRDP=[<code><cid></code>] Response(s) [+CGEQOSRDP: <code><cid></code> , <code><QCI></code> , [<code><DL_GBR></code> , <code><UL_GBR></code>], [<code><DL_MBR></code> , <code><UL_MBR></code>][, <code><DL_AMBR></code> , <code><UL_AMBR></code>]] [+CGEQOSRDP: ...] OK ERROR +CME ERROR: <code><err></code>	
PIN → Last + - -	Reference(s) 3GPP TS 27.007 [39]

Parameter Description

`<cid>`^(str)

Specifies a particular EPS Traffic Flows definition in EPS and a PDP Context definition in UMTS/GPRS (see [AT+CGDCONT](#) and [AT+CGDSCONT](#)).

`<QCI>`^(num)

Specifies a class of EPS QoS.

0	QCI is selected by network
1...4	Value range for guaranteed bit rate Traffic Flows
5...9	Value range for non-guaranteed bit rate Traffic Flows
128...254	Value range for for Operator-specific QCIs

`<DL_GBR>`^(num)

Indicates DL GBR in case of GBR QCI. The value is in kbit/s. This parameter is omitted for a non-GBR QCI.

`<UL_GBR>`^(num)

Indicates UL GBR in case of GBR QCI. The value is in kbit/s. This parameter is omitted for a non-GBR QCI.

<DL_MBR>^(num)

Indicates DL MBR in case of GBR QCI. The value is in kbit/s. This parameter is omitted for a non-GBR QCI.

<UL_MBR>^(num)

Indicates UL MBR in case of GBR QCI. The value is in kbit/s. This parameter is omitted for a non-GBR QCI.

<DL_AMBR>^(num)

Indicates DL APN aggregate MBR. The value is in kbit/s.

<UL_AMBR>^(num)

Indicates UL APN aggregate MBR. The value is in kbit/s.

Note

- If multiple lines in a response belong to the same PDN connection they contain the same <DL_AMBR> <UL_AMBR> values.

10.12 AT+CGCONTRDP PDP context read dynamic parameters

The [AT+CGCONTRDP](#) write command returns dynamic parameters for the active non-secondary PDP context specified with `<cid>`.

The [AT+CGCONTRDP](#) execute command returns dynamic parameters for all active non-secondary PDP contexts. For contexts of `<PDP_type>` "IPV4V6" the response of exec and write command will have two lines per `<cid>`. First line describes the IPV4 dynamic parameters followed by another line with the IPV6 dynamic parameters.

Syntax

<p>Test Command</p> <pre>AT+CGCONTRDP=?</pre> <p>Response(s)</p> <pre>+CGCONTRDP: (list of supported <cid>s) associated with active contexts OK</pre>	
<p>Exec Command</p> <pre>AT+CGCONTRDP</pre> <p>Response(s)</p> <pre>+CGCONTRDP: <cid>, <Bearer_ID>, <APN>[, <LocalAddr and SubNetMask>[, <GwAddr>[, <DNS_prim_addr>[, <DNS_sec_addr>[, <IM_CN_Signalling_Flag>[, <LipaIndication>]]]]]] +CGCONTRDP: <cid>, <Bearer_ID>, <APN>[, <LocalAddr and SubNetMask>[, <GwAddr>[, <DNS_prim_addr>[, <DNS_sec_addr>[, <IM_CN_Signalling_Flag>[, <LipaIndication>]]]]]] [+CGCONTRDP: ...] OK ERROR +CME ERROR: <err></pre>	
<p>Write Command</p> <pre>AT+CGCONTRDP=<cid></pre> <p>Response(s)</p> <pre>+CGCONTRDP: <cid>, <Bearer_ID>, <APN>[, <LocalAddr and SubNetMask>[, <GwAddr>[, <DNS_prim_addr>[, <DNS_sec_addr>[, <IM_CN_Signalling_Flag>[, <LipaIndication>]]]]]] OK ERROR +CME ERROR: <err></pre>	
<p>PIN → Last</p> <pre>+ - -</pre>	<p>Reference(s)</p> <p>3GPP TS 27.007 [39]</p>

Parameter Description

<p><code><cid></code>^(num)</p> <p>Specifies a particular non-secondary PDP context definition. The parameter is local to the TE-MT interface and is used in other PDP context-related commands. See AT+CGDCONT.</p>
<p><code><Bearer_ID></code>^(num)</p> <p>Identifies the bearer, EPS Bearer in EPS and NSAPI in UMTS/GPRS.</p>
<p><code><APN></code>^(str)</p> <p>Access Point Name</p> <p>Logical name used to select the GGSN or the external packet data network.</p>

<LocalAddr and SubNetMask>^(str)

Shows the IP address and subnet mask of the UE in the format specified by [AT+CGPIAF](#).

<GwAddr>^(str)

Shows the Gateway Address of the UE in the format specified by [AT+CGPIAF](#).

<DNS_prim_addr>^(str)

Shows the IP address of the primary DNS server.
The settings of [AT+CGPIAF](#) influences the format of this parameter.

<DNS_sec_addr>^(str)

Shows the IP address of the secondary DNS server.
The settings of [AT+CGPIAF](#) influences the format of this parameter.

<IM_CN_Signalling_Flag>^(num)

Shows whether the PDP context is for IM CN subsystem-related signalling only or not.

<LipaIndication>^(num)

Indicates that the PDP context provides connectivity using a LIPA PDN connection. This parameter cannot be set by the TE.

0	Indication not received that the PDP context provides connectivity using a LIPA PDN connection.
1	Indication received that the PDP context provides connectivity using a LIPA PDN connection.

10.13 AT+CGSCONTRDP Secondary PDP Context Read Dynamic Parameters

The write command returns `<p_cid>` and `<bearer_ID>` and `<IM_CN_Signalling_Flag>` for an active secondary PDP context with the context identifier `<cid>`.

If the parameter `<cid>` is omitted, the `<cid>`, `<p_cid>` and `<bearer_ID>` and `<IM_CN_Signalling_Flag>` are returned for all active secondary PDP contexts. In EPS, the Traffic Flow parameters are returned.

The test command returns a list of `<cid>`s associated with active secondary PDP contexts.

Syntax

<p>Test Command</p> <pre>AT+CGSCONTRDP=?</pre> <p>Response(s)</p> <pre>+CGSCONTRDP: (list of <cid>s associated with active contexts) OK</pre>	
<p>Write Command</p> <pre>AT+CGSCONTRDP=[<cid>]</pre> <p>Response(s)</p> <pre>[+CGSCONTRDP: <cid>, <p_cid>, <bearer_ID>[, <IM_CN_Signalling_Flag>]] [+CGSCONTRDP: <cid>, <p_cid>, <bearer_ID>[, <IM_CN_Signalling_Flag>]] [+CGSCONTRDP: ...] OK ERROR +CME ERROR: <err></pre>	
<p>PIN → Last</p> <pre>+ - -</pre>	<p>Reference(s)</p> <p>3GPP TS 27.007 [39]</p>

Parameter Description

`<cid>`^(num)

Specifies a particular active secondary PDP context or Traffic Flows definition. The parameter is used in other PDP context-related commands (see the [AT+CGDCONT](#) and [AT+CGDSCONT](#)).

`<p_cid>`^(num)

Specifies a particular PDP context definition or default EPS context Identifier which has been specified by use of the [AT+CGDSCONT](#) command (see the [AT+CGDSCONT](#) command).

`<bearer_ID>`^(num)

Identifies the bearer, EPS Bearer in EPS and NSAPI in UMTS/GPRS.

`<IM_CN_Signalling_Flag>`^(num)

IM CN Signalling Flag

Shows whether the PDP context is for IM CN subsystem-related signalling only or not.

- | | |
|---|---|
| 0 | PDP context is not for IM CN subsystem-related signalling only. |
| 1 | PDP context is for IM CN subsystem-related signalling only. |

Parameter Description

`<cid>`^(num)

Parameter specifies a particular PDP context definition. The parameter is local to the TE-MT interface and is used in other PDP context-related commands.

1...8

`<filterid>`^(num)

Packet filter identifier

Parameter specifies a packet filter identifier.

1...16

`<precedence>`^(num)

Evaluation Precedence Index

Parameter specifies a evaluation precedence index.

0...255

`<rem_addr_subnet_mask>`^(str)

Remote address and subnet mask

The string is given as dot-separated numeric (0-255) parameters on the form:

for IPv4: "a1.a2.a3.a4.m1.m2.m3.m4"

for IPv6:

"a1.a2.a3.a4.a5.a6.a7.a8.a9.a10.a11.a12.a13.a14.a15.a16.m1.m2.m3.m4.m5.m6.m7.m8.m9.m10.m11.m12.m13.m14.m15.m16".

The settings of [AT+CGPIAF](#) can influence the format of this parameter.

`<protocolno>`^(num)

Protocol number

Parameter specifies the protocol number (ipv4) / next header (ipv6).

0...255

`<destportrange>`^(str)

Destination port range

Parameter specifies the destination port range.

0.0...65535.65535

`<srcportrange>`^(str)

Source port range

Parameter specifies the source port range.

0.0...65535.65535

`<ipsecidx>`^(num)

IPsec security parameter index

Parameter specifies the IPsec security parameter index (spi).

00000000...FFFFFFFF

<tos>^(str)

Type of service and mask/traffic class

Parameter specifies the type of service (tos)(ipv4) and mask/traffic class (ipv6).

0.0...255.255

<flowlabel>^(num)

Flow label

Parameter specifies the flow label (ipv6).

00000...FFFFFF

<direction>^(num)

Parameter specifies the transmission direction in which the packet filter shall be applied.

0	Pre-Release 7 TFT filter (see 3GPP TS 24.008 [8], table 10.5.162)
1	Uplink
2	Downlink
3	Bidirectional (Up and Downlink) (default if omitted)

<pdptype>^(str)

PDP type

Parameter specifies the PDP type.

"IP"	Internet Protocol (IETF STD 5)
"IPV6"	Internet Protocol, version 6 (see RFC 2460)
"IPV4V6"	Virtual <pdptype> introduced to handle dual IP stack UE capability. (See 3GPP TS 24.301)

Note

- Some of the above listed attributes may coexist in a Packet Filter while others mutually exclude each other, the possible combinations are shown in 3GPP TS 23.060.

10.15 AT+CGTFTRDP Traffic Flow Template Read Dynamic Parameters

The write command returns the relevant information about Traffic Flow Template for an active secondary or non-secondary PDP context specified by `<cid>` together with the additional network assigned values when established by the network.

The exec command returns the relevant information about the Traffic Flow Templates for all active secondary and non-secondary PDP contexts.

Parameters of both network and MT/TA initiated PDP contexts will be returned.

The test command returns a list of `<cid>`s associated with active secondary and non-secondary contexts.

Syntax

<p>Test Command</p> <pre>AT+CGTFTRDP=?</pre> <p>Response(s)</p> <pre>+CGTFTRDP: (list of <cid>s associated with active contexts) OK</pre>	
<p>Exec Command</p> <pre>AT+CGTFTRDP</pre> <p>Response(s)</p> <pre>[+CGTFTRDP: <cid>, <filterid>, <precedence>, <rem_addr_subnet_mask>, <protocolno>, <local-portrange>, <remote-portrange>, <ipsecidx>, <tos>, <flowlabel>, <direction>, <NW-filterID>] [+CGTFTRDP: ...] OK ERROR +CME ERROR: <err></pre>	
<p>Write Command</p> <pre>AT+CGTFTRDP=<cid></pre> <p>Response(s)</p> <pre>[+CGTFTRDP: <cid>, <filterid>, <precedence>, <rem_addr_subnet_mask>, <protocolno>, <local-portrange>, <remote-portrange>, <ipsecidx>, <tos>, <flowlabel>, <direction>, <NW-filterID>] [+CGTFTRDP: ...] OK ERROR +CME ERROR: <err></pre>	
<p>PIN → Last</p> <pre>+ - -</pre>	<p>Reference(s)</p> <p>3GPP TS 27.007 [39]</p>

Parameter Description

<p><code><cid></code>^(num)</p> <p>Specifies a particular secondary or non secondary PDP context definition or Traffic Flows definition (see AT+CGDCONT and AT+CGDSCONT commands).</p> <p>1...8</p>

<filterid>^(num)

Packet filter identifier

Specifies a packet filter identifier.

1...16

<precedence>^(num)

Evaluation Precedence Index

Specifies a evaluation precedence index.

0...255

<rem_addr_subnet_mask>^(str)

Remote address and subnet mask

The string is given as dot-separated numeric (0-255) parameters on the form:

"a1.a2.a3.a4.m1.m2.m3.m4" for IPv4 or

"a1.a2.a3.a4.a5.a6.a7.a8.a9.a10.a11.a12.a13.a14.a15.a16.m1.m2.m3.m4.m5.m6.m7.m8.m9.m10.m11.m12.m13.m14.m15.m16" for IPv6.

The settings of [AT+CGPIAF](#) can influence the format of this parameter.

<protocolno>^(num)

Protocol number

Specifies the protocol number (ipv4) / next header (ipv6).

0...255

<local-portrange>^(str)

Local port range

The string is given as dot-separated numeric (0-65535) parameters on the form "f.t".

<remote-portrange>^(str)

Remote port range

The string is given as dot-separated numeric (0-65535) parameters on the form "f.t".

<ipsecidx>^(str)

IPsec security parameter index

Specifies the IPsec security parameter index (spi) in hexadecimal format.

"00000000...FFFFFFFF"

<tos>^(str)

Type of service and mask/traffic class

Specifies the type of service (tos)(ipv4) and mask/traffic class (ipv6) and mask. The string is given as dot-separated numeric (0-255) parameters on the form "f.t".

<flowlabel>^(str)

Flow label

Parameter specifies the flow label in hexadecimal format (valid for ipv6 only).

"00000...FFFFFF"

<direction>^(num)

Specifies the transmission direction in which the Packet Filter will be applied.

0	Pre Release 7 TFT Filter
1	Uplink
2	Downlink
3	Bidirectional (Used for Uplink and Downlink)

<NW-filterID>^(num)

NW Packet filter identifier

Parameter specifies a packet filter identifier. In EPS the value is assigned by the network when established.

1...16

Note

- Some of the listed attributes can coexist in a Packet Filter while others mutually exclude each other. The possible combinations are shown in 3GPP TS 23.060 [21].

10.16 AT+CGAUTH Define PDP Context Authentication Parameters

The [AT+CGAUTH](#) write command specifies the type of authentication protocol for the specified PDP context. The [AT+CGAUTH](#) read command returns the current settings for each defined PDP context. If no PDP context is defined the read command returns only OK result code.

Syntax

<p>Test Command</p> <p>AT+CGAUTH=?</p> <p>Response(s)</p> <p>+CGAUTH: (range of supported<cid>s), (list of supported <auth_prot>s), (max. string length of <userId>s), (max. string length of <password>s)</p> <p>OK</p> <p>ERROR</p> <p>+CME ERROR: <err></p>	
<p>Read Command</p> <p>AT+CGAUTH?</p> <p>Response(s)</p> <p>[+CGAUTH: <cid>, <auth_prot>, <userId>, <password>]</p> <p>[+CGAUTH: <cid>, <auth_prot>, <userId>, <password>]</p> <p>[+CGAUTH: ...]</p> <p>OK</p> <p>ERROR</p> <p>+CME ERROR: <err></p>	
<p>Write Command</p> <p>AT+CGAUTH=<cid>[, <auth_prot>[, <userId>, <password>]]</p> <p>Response(s)</p> <p>OK</p> <p>ERROR</p> <p>+CME ERROR: <err></p>	
<p>PIN → Last</p> <p>- + -</p>	<p>Reference(s)</p> <p>3GPP TS 27.007 [39]</p>

Parameter Description

<cid> ^{(num)(NV)}	
Specifies a particular PDP context definition (see AT+CGDCONT parameter <cid>).	
1...8	
<auth_prot> ^{(num)(NV)}	
Types of authentication to be used for specified PDP context.	
[0]	none Used to indicate that no authentication protocol is used for this PDP context. Username and password are removed if previously specified.
1	PAP
2	CHAP

<userId>^{(str)(NV)}

Specifies the user name used for authentication.

<password>^{(str)(NV)}

Specifies the password used for authentication.

10.17.1 Automatic deactivation of PDP context during dial-up PPP

When using the [AT+CGDATA](#) write command or [ATD*99#](#) the MT issues the intermediate result code CONNECT and enters V.250ter online data state. In V.250 online data state, first some LCP protocol exchange between MT and TE is performed to set up the PPP link. After successfully establishing the PPP link, the MT performs the PDP context activation procedure if the context is not already activated. As a result, the MT is in a "PDP context activated" state within the PLMN, the PPP link is established on the mobile side and the mobile is ready for IP data transfer.

If the TE wants to close the LCP link the MT may perform an LCP termination request procedure on PPP level. After this LCP termination procedure the MT deactivates the PDP context automatically and the MT returns to V.250 command mode and issues the final result code NO CARRIER.

During the implicit PDP context deactivation procedure after LCP termination the TE may change into V.250 command state (e.g. by using [+++](#) or by toggling DTR if [AT&D](#) is set to 1) before the result NO CARRIER occurs. In this case the application should not try to deactivate the PDP context by using the commands [AT+CGACT](#) or [ATH](#). If DTR is configured to disconnect data connections ([AT&D2](#)), then the application should not toggle DTR during the implicit PDP context deactivation and before "NO CARRIER" is received.

10.18 AT+CGSMS Select Service for MO Short messages

[AT+CGSMS](#) specifies the service or service preference that the MT will use to send MO (mobile originated) short messages.

Syntax

Test Command AT+CGSMS=? Response(s) +CGSMS: (list of supported <service>s) OK	
Read Command AT+CGSMS? Response(s) +CGSMS: <service> OK	
Write Command AT+CGSMS= [<service>] Response(s) OK ERROR +CME ERROR: <err>	
PIN → Last + + -	Reference(s) 3GPP TS 27.007 [39]

Parameter Description

<service> ^(num)	
A numeric parameter which indicates the service or service preference to be used. Parameter is global for all interfaces and volatile.	
0 ^(P)	Packet Domain
1	Circuit switched
2	Packet Domain preferred (use circuit switched SMS transfer if mobile is not PS attached)
3	Circuit switched preferred (use Packet Domain if circuit switched is not available)

Notes

- Sending SMS via Packet Domain is only possible when mobile is attached using [AT+CGATT](#).
- The command has been added only for compatibility reasons, and has no effect.

11. Short Message Service (SMS) Commands

The AT Commands described in this chapter allow an external application to use the Short Message Service with the ELS31-V.

11.1 SMS Parameters

Parameter Description

`<ackpdu>`^(num)

Format is same for `<pdu>` in case of SMS, but without 3GPP TS 24.011 [32] SC address field and parameter shall be bounded by double quote characters like a normal string type parameter

`<alpha>`^{(str)(+CSCS)}

String type alphanumeric representation of `<da>` or `<oa>` corresponding to the entry found in phonebook. This feature is not supported.

`<cdata>`^(num)

Command Data

3GPP TS 23.040 [29] TP-Command-Data in text mode responses; UE converts each 8-bit octet into two IRA character long hexadecimal numbers, e.g. octet with integer value 42 is represented as two characters "2A", IRA 50 and 65 (decimal).

`<ct>`^(num)

Command Type

3GPP TS 23.040 [29] TP-Command-Type in integer format

0...255

`<da>`^{(str)(+CSCS)}

Destination Address

3GPP TS 23.040 [29] TP- Destination-Address Address-Value field in string format; BCD numbers (or GSM default alphabet characters) are converted into characters; type of address given by `<to da>`

`<data>`^{(num)(+CSCS)}

User Data

In case of SMS: 3GPP TS 23.040 [29] TP-User-Data in text mode responses; format:

- If `<dcs>` indicates that 3GPP TS 23.038 [28] GSM 7 bit default alphabet is used and `<fo>` indicates that 3GPP TS 23.040 [29] TP-User-Data-Header-Indication is not set: UE converts GSM alphabet into current TE character set according to rules covered in Annex A.
- If `<dcs>` indicates that 8-bit or UCS2 data coding scheme is used, or `<fo>` indicates that 3GPP TS 23.040 [29] TP-User-Data-Header-Indication is set: UE converts each 8-bit octet into hexadecimal numbers containing two IRA characters, e.g. octet with integer value 42 is represented as two characters "2A", IRA 50 and 65 (decimal).

11.1 SMS Parameters

<dt>^(num)

Discharge Time

3GPP TS 23.040 [29] TP-Discharge-Time in time-string format: "yy/MM/dd,hh:mm:ss+zz", where characters indicate year (two last digits), month, day, hour, minutes, seconds and time zone. For example, 6th of May 1994, 22:10:00 GMT+2 hours equals "94/05/06,22:10:00+08"

<index>^(num)

Integer type; value in the range of location numbers supported by the associated memory

<length>^(num)

Message Length

Integer type value indicating in the text mode (**AT+CMGF=1**) the length of the message body **<data>** (or **<cdata>**) in characters; or in PDU mode (**AT+CMGF=0**), the length of the actual TP data unit in octets (i.e. the RP layer SMSC address octets are not counted in the length) In text mode, the maximum length of an SMS depends on the used coding scheme: It is 160 characters if the 7 bit GSM coding scheme is used, and 140 characters according to the 8 bit GSM coding scheme.

If the SMS message format is "text mode" (**AT+CMGF=1**) and the character set is set to "UCS2" with **AT+CSCS** and the SMS is also coded as "UCS2" (see **<dcs>** of **AT+CSMP**), then the length is in octets instead of characters.

<mem1>^(str)

Memory to be used when listing, reading and deleting messages:

"SM"	SIM message storage
"ME"	Mobile Equipment message storage
"SR"	Status report message storage

<mem2>^(str)

Memory to be used when writing and sending messages:

"SM"	SIM message storage
"ME"	Mobile Equipment message storage

<mem3>^(str)

Received messages will be placed in this memory storage if routing to TE is not set. See command **AT+CNMI** with parameter **<mt>=2**.

Received status reports are always stored in "SR" unless directly forwarded to TE.

"SM"	SIM message storage
"ME"	Mobile Equipment message storage
"SR"	Status report message storage

<mn>^(num)

Message Number

3GPP TS 23.040 [29] TP-Message-Number in integer format

<mr>^(num)

Message Reference

3GPP TS 23.040 [29] TP-Message-Reference in integer format

11.1 SMS Parameters

`<oa>(str)(+CSCS)`

Originating Address

3GPP TS 23.040 [29] TP-Originating-Address Address-Value field in string format; BCD numbers (or GSM default alphabet characters) are converted into characters; type of address given by `<toa>`

`<pdu>(num)`

In the case of SMS: 3GPP TS 24.011 [32] SC address followed by 3GPP TS 23.040 [29] TPDU in hexadecimal format: UE converts each octet of TP data unit into hexadecimal numbers containing two IRA characters, e.g. octet with integer value 42 is represented as two characters "2A", IRA 50 and 65 (decimal). In the case of CBS: `<ra>` 3GPP TS 23.040 [29] TP-Recipient-Address Address-Value field in string format; BCD numbers (or GSM default alphabet characters) are converted into characters; type of address given by `<tora>`

`<ra>(str)(+CSCS)`

Recipient Address

3GPP TS 23.040 [29] TP-Recipient-Address Address-Value field in string format; BCD numbers (or GSM default alphabet characters) are converted to characters of the currently selected TE character set (refer to command `AT+CSCS`.); type of address given by `<tora>`

`<sca>(str)(+CSCS)`

Service Center Address

3GPP TS 24.011 [32] RP SC address Address-Value field in string format; BCD numbers (or GSM default alphabet characters) are converted to characters of the currently selected TE character set (`AT+CSCS`); type of address given by `<tosca>`

`<scts>(num)`

Service Centre Time Stamp

3GPP TS 23.040 [29] TP-Service-Centre-Time-Stamp in time-string format (refer `<dt>`)

`<st>(num)`

Status

3GPP TS 23.040 [29] TP-Status in integer format

0...255

`<stat>(str)`

Message status

3GPP TS 27.005 [38] Interface of SMS and CB. Indicates the status of message in memory.

Description	text mode (<code><mode>=1</code>)	PDU mode (<code><mode>=0</code>)	Default
Received unread messages	"REC UNREAD"	0	for SMS reading commands
Received read messages	"REC READ"	1	
Stored unsent messages	"STO UNSENT"	2	for SMS writing commands
Stored sent messages	"STO SENT"	3	
All messages	"ALL"	4	

11.1 SMS Parameters

<toda>^(num)

Type of Destination Address

3GPP TS 24.011 [32] TP-Destination-Address Type-of-Address octet in integer format (when first character of <da> is + (IRA 43) default is 145, otherwise default is 129)

0...255

<toa>^(num)

Type of Originating Address

3GPP TS 24.011 [32] TP-Originating-Address Type-of-Address octet in integer format (default refer <toda>)

<tora>^(num)

Type of Recipient Address

3GPP TS 24.011 [32] TP-Recipient-Address Type-of-Address octet in integer format (default refer <toda>)

<tosca>^(num)

Type of Service Center Address

3GPP TS 24.011 [32] RP SC address Type-of-Address octet in integer format (default refer <toda>)

<text>^(str)

Text of the short message

<save>^(num)

[0]	Do not save short message.
1	Save short message.

<priority>^(num)

[0]	Normal
1	Interactive
2	Urgent
3	Emergency

<ackstatus>^(num)

Value of the delivery status when the SMS fragment has been successfully delivered.

<localTS>^(str)

Local time stamp in time-string format (refer <dt>).

<CbKNumber>^(str)

Callback number.

<sendStat>^(str)Send status of short message. This parameter is not used.
"UNUSED"

11.2 AT+CMGC Send SMS Command

Syntax

Test Command	
AT+CMGC=?	
Response(s)	
OK	
Write Command	
If text mode (see AT+CMGF=1)	
AT+CMGC=<fo>, <ct>[, <pid>[, <mn>[, <da>[, <toda>]]]]<CR> Text can be entered <CTRL-Z>/<ESC>	
Response(s)	
+CMGC: <mr>[, <scts>]	
If sending fails	
ERROR	
+CMS ERROR: <err>	
Write Command	
If PDU mode (see AT+CMGF=0)	
AT+CMGC=<length><CR> PDU can be entered <CTRL-Z>/<ESC>	
Response(s)	
+CMGC: <mr>[, <ackpdu>]	
OK	
If sending fails	
ERROR	
+CMS ERROR: <err>	
PIN → Last	Reference(s)
+ - -	3GPP TS 27.005 [38]

Notes

- After invoking the commands [AT+CMGW](#), [AT+CMGS](#) or [AT+CMGC](#) it is necessary to wait for the prompt ">" before entering text or PDU.
- In general but especially at baudrates below 19200 it is recommended to only use the command line termination character ([ATS3](#)) before starting text or PDU input. Use of line termination character followed by an additional response formatting character ([ATS4](#)) may cause the problem that the latter will become part of the input data.

11.3 AT+CMGD Delete short message

The AT+CMGD write command deletes a short message from the preferred message storage <mem1> location <index>. If <delflag> is present and not set to 0 then the UE shall ignore <index> and follow the rules for <delflag> shown below. If deleting fails, final result code +CMS ERROR is returned.

The AT+CMGD test command returns the valid <index> locations of the preferred <mem1> and the supported <delflag> values.

Note: To delete 3GPP2 SMS over IMS, consider using AT^SMGDIMS.

Syntax

Test Command	
AT+CMGD=?	
Response(s)	
+CMGD: (list of supported <index>s), (list of supported <delflag>es)	
OK	
Write Command	
AT+CMGD=<index>[, <delflag>]	
Response(s)	
OK	
ERROR	
+CMS ERROR: <err>	
PIN → Last	Reference(s)
+ + -	3GPP TS 27.005 [38]

Parameter Description

<index> ^(num)	
Integer type; value in the range of location numbers supported by the associated memory. See <index>.	
<delflag> ^(num)	
0	(Or omitted) delete the message specified in <index>.
1	Delete all read messages from preferred message storage, leaving unread messages and stored mobile originated messages (whether sent or not) untouched.
2	Delete all read messages from preferred message storage and sent mobile originated messages, leaving unread messages and unsent mobile originated messages untouched.
3	Delete all read messages from preferred message storage, sent and unsent mobile originated messages leaving unread messages untouched.
4	Delete all messages from preferred message storage including unread messages.

Note

- If there is no short message stored at the selected index, the response is "+CMS ERROR: invalid memory index".

11.4 AT+CMGF Select SMS message format

The [AT+CMGF](#) command specifies the input and output format of the short messages.

Syntax

Test Command	
AT+CMGF=?	
Response(s)	
+CMGF: (list of supported <mode>s)	
OK	
Read Command	
AT+CMGF?	
Response(s)	
+CMGF: <mode>	
OK	
ERROR	
+CMS ERROR: <err>	
Write Command	
AT+CMGF=[<mode>]	
Response(s)	
OK	
ERROR	
+CMS ERROR: <err>	
PIN → Last	Reference(s)
- + -	3GPP TS 27.005 [38]

Parameter Description

<mode> ^{(num)(&V)(&W)}	
[0] ^{(&F)(D)}	PDU mode (default when implemented)
1	Text mode

11.5 AT+CMGL List SMS messages from preferred store

The write command returns messages with status value `<stat>` from message storage `<mem1>` to the TE. If the status of the message is 'received unread', the status in the storage changes to 'received read'. The execute command is the same as the write command with the given default for `<stat>`.

Note: To list 3GPP2 SMS over IMS, consider using `AT^SMGLIMS`.

Syntax

Test Command	
AT+CMGL=?	
Response(s)	
+CMGL: (list of supported <code><stat></code> s)	
OK	
Exec Command	
AT+CMGL	
Response(s)	
+CMGL: (see write command for default of <code><stat></code>)	
OK	
Write Command	
AT+CMGL= <code><stat></code>	
Response(s)	
Output if text mode (<code>AT+CMGF=1</code>) and command successful:	
For SMS- SUBMITs and/or SMS-DELIVERs	
+CMGL: <code><index></code> , <code><stat></code> , <code><oa>/<da></code> , [<code><alpha></code>], [<code><scts></code>]], <code><toa>/<tda></code> , <code><length></code>] <code><CR><LF><data><CR><LF></code>	
[...]	
OK	
For SMS-STATUS-REPORTs	
+CMGL: <code><index></code> , <code><stat></code> , <code><fo></code> , <code><mr></code> , [<code><ra></code>], [<code><tora></code>], <code><scts></code> , <code><dt></code> , <code><st></code> <code><CR><LF></code>	
[...]	
OK	
For SMS-Commands	
+CMGL: <code><index></code> , <code><stat></code> , <code><fo></code> , <code><ct></code> <code><CR><LF></code>	
[...]	
OK	
Output if PDU mode <code>AT+CMGF=0</code> and command successful:	
For SMS-SUBMITs and/or SMS-DELIVERs	
+CMGL: <code><index></code> , <code><stat></code> , [<code><alpha></code>], <code><length></code> <code><CR><LF><pdu><CR><LF></code>	
[...]	
OK	
If error is related to ME functionality	
ERROR	
+CMS ERROR: <code><err></code>	
PIN → Last	
+ + -	
Reference(s)	
3GPP TS 27.005 [38]	

Notes

- The selected [<mem1>](#) can contain different types of SMs (e.g. SMS-DELIVERs, SMS-SUBMITs, SMS-STATUS-REPORTs and SMS-COMMANDs), the response may be a mix of the responses of different SM types. TE application can recognize the response format by examining the third response parameter.
- Users should be aware that when using this AT command quickly after SIM PIN authentication the SIM data may not yet be accessible, resulting in a short delay before the requested AT command response is returned.

11.6 AT+CMGR Read SMS messages

The write command returns SMS message with location value `<index>` from message storage `<mem1>` to the TE. If status of the message is 'received unread', status in the storage changes to 'received read'.

When using Text mode it is recommended to set `AT+CSDH=1`. In this case the `AT+CMGR` write command responses will include detailed header information. See `AT+CSDH` for details.

Note: To read 3GPP2 SMS over IMS, consider using `AT^SMGRIMS`.

Syntax

<p>Test Command</p> <pre>AT+CMGR=?</pre> <p>Response(s)</p> <pre>OK</pre>	
<p>Write Command</p> <pre>AT+CMGR=<index></pre> <p>Response(s)</p> <p>Output if text mode (<code>AT+CMGF=1</code>) and command successful:</p> <p>For SMS-DELIVER</p> <pre>+CMGR: <stat>, <oa>, [<alpha>], <scts>[, <tooa>, <fo>, <pid>, <dc>, <sca>, <tosca>, <length>]<CR><LF><data></pre> <p>[...]</p> <pre>OK</pre> <p>For SMS-SUBMIT</p> <pre>+CMGR: <stat>, <da>, [<alpha>][, <toda>, <fo>, <pid>, <dc>, [<vp>], <sca>, <tosca>, <length>]<CR><LF><data></pre> <p>[...]</p> <pre>OK</pre> <p>For SMS-STATUS-REPORT</p> <pre>+CMGR: <stat>, <fo>, <mr>, [<ra>], [<tora>], <scts>, <dt>, <st> <data></pre> <p>[...]</p> <pre>OK</pre> <p>For SMS-Commands</p> <pre>+CMGR: <stat>, <fo>, <ct>[, <pid>, [<mn>], [<da>], [<toda>], <length>]<CR><LF><data></pre> <p>[...]</p> <pre>OK</pre> <p>Output if PDU mode (<code>AT+CMGF=0</code>) and command successful:</p> <p>For SMS-SUBMITs and/or SMS-DELIVERs</p> <pre>+CMGR: <stat>, [<alpha>], <length><CR><LF><pdu></pre> <p>[...]</p> <pre>OK</pre> <p>ERROR</p> <pre>+CMS ERROR: <err></pre>	
<p>PIN → Last</p> <pre>+ + -</pre>	<p>Reference(s)</p> <p>3GPP TS 27.005 [38]</p>

Notes

- Response if [AT+CMGR](#) is used to read an empty record index: +CMGR: 0,,0
- Response if [AT+CMGR](#) is used to read a non-existent record index: +CMS ERROR: invalid memory index

11.7 AT+CMGS Send SMS

AT+CMGS write command transmits a short message to network (SMS-SUBMIT).

After invoking the write command wait for the prompt ">" and then start to write the message. To send the message simply enter <CTRL-Z>.

To abort sending use <ESC>. Abortion is acknowledged with "OK", though the message will not be sent.

The message reference <mr> is returned by the UE on successful message delivery. The value can be used to identify the message in a delivery status report provided as an unsolicited result code.

Note: To send 3GPP2 SMS over IMS, consider using AT^SMGSIMS.

Syntax

<p>Test Command</p> <p>AT+CMGS=?</p> <p>Response(s)</p> <p>OK</p>	
<p>Write Command</p> <p>If text mode (see AT+CMGF=1)</p> <p>AT+CMGS=<da>[, <toda>]<CR> Text can be entered. <CTRL-Z>/<ESC></p> <p>Response(s)</p> <p>+CMGS: <mr>[, <scts>]</p> <p>OK</p> <p>If sending fails see notes below.</p>	
<p>Write Command</p> <p>If PDU mode (see AT+CMGF=0)</p> <p>AT+CMGS=<length><CR> PDU can be entered. <CTRL-Z>/<ESC></p> <p>Response(s)</p> <p>+CMGS: <mr>[, <ackpdu>]</p> <p>OK</p> <p>If sending fails see notes below.</p>	
<p>PIN → Last</p> <p>+ - -</p>	<p>Reference(s)</p> <p>3GPP TS 27.005 [38]</p>

Notes

- Note that some providers do not recognize an @ symbol used in a short message. A widely used alternative is typing "*" as defined in 3GPP TS 23.040 [29].
- All characters entered behind the prompt ">" will be recognized as GSM characters. For example, "Backspace" (ASCII character 8) does not delete a character, but will be inserted into the short message as an additional physical character. As a result, the character you wanted to delete still appears in the text, plus the GSM code equivalent of the Backspace key.
- Message Length in Text Mode
 The maximum length of a short message depends on the used coding scheme: It is 160 characters if the 7 bit GSM coding scheme is used, and 140 characters according to the 8 bit GSM coding scheme. In case UCS2 character set selected it is highly recommended to set Data Coding Scheme (<dcs> of AT+CSMP) to 16-bit data, otherwise the length of sms user data is restricted to 88 octets. Even better for messages with UCS2 character set is the PDU Mode.
- In general but especially at baudrates below 19200 it is recommended to only use the command line termination character (ATS3) before starting text or PDU input. Use of line termination character followed by an additional response formatting character (ATS4) may cause the problem that the latter will become part of the input data.

11.8 AT+CMGW Write Short Messages to Memory

[AT+CMGW](#) execute and write commands transmit a short message (either SMS-DELIVER or SMS-SUBMIT) from TE to memory storage [<mem2>](#). Memory location [<index>](#) of the stored message is returned. Message status will be set to 'stored unsent' unless otherwise given in parameter [<stat>](#).

After invoking the execute or write command wait for the prompt ">" and then start to write the message. To save the message simply enter <CTRL-Z>. To abort writing use <ESC>. Abortion is acknowledged with "OK", though the message will not be saved.

Message Length in Text Mode: The maximum length of a short message depends on the used coding scheme configured with [<dc>](#) of [AT+CSMP](#):

7 bit GSM coding scheme: 160 characters

8 bit GSM coding scheme: 140 characters

16 bit GSM coding scheme: 70 characters.

The length of 8-bit data coded short messages has to be greater than 0.

Note: To send 3GPP2 SMS over IMS, consider using [AT^SMGSIMS](#).

Syntax

Test Command

```
AT+CMGW=?
```

Response(s)

```
OK
```

Exec Command

If text mode (see [AT+CMGF=1](#)):

```
AT+CMGW
```

Response(s)

```
<CR> Text can be entered. <CTRL-Z>/<ESC>
```

```
+CMGW: <index>
```

```
OK
```

If writing fails

```
ERROR
```

```
+CMS ERROR: <err>
```

Write Command

If text mode (see [AT+CMGF=1](#)):

```
AT+CMGW=<oa>/<da>[, [<tooa>/<toda>]], <stat>]<CR> Text can be entered. <CTRL-Z>/<ESC>
```

Response(s)

```
+CMGW: <index>
```

```
OK
```

If writing fails see notes below.

Write Command

If PDU mode (see [AT+CMGF=0](#)):

```
AT+CMGW=<length>[, <stat>]<CR> PDU can be entered. <CTRL-Z>/<ESC>
```

Response(s)

```
+CMGW: <index>
```

```
OK
```

If writing fails see notes below.

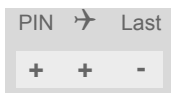

Reference(s)
3GPP TS 27.005 [38], 3GPP TS 23.038 [28]

Notes

- Note that some providers do not recognize an @ symbol used in a short message. A widely used alternative is typing "*" as defined in 3GPP TS 23.040 [29].
- In general but especially at baudrates below 19200 it is recommended to only use the command line termination character (ATS3) before starting text or PDU input. Use of line termination character followed by an additional response formatting character (ATS4) may cause the problem that the latter will become part of the input data.
- SMS-COMMANDs and SMS-STATUS-REPORTs cannot be stored in text mode.
- All characters entered behind the ">" prompt will be recognized as GSM characters. For example, "Backspace" (ASCII character 8) does not delete a character, but will be inserted into the short message as an additional physical character. As a result, the character you wanted to delete still appears in the text, plus the GSM code equivalent of the Backspace key.

11.9 AT+CMMS More Messages to Send

AT+CMMS controls the continuity of the SMS relay protocol link. If the feature is enabled (and supported by the currently used network) multiple messages can be sent faster as the link is kept open.

Note: To send 3GPP2 SMS over IMS, consider using [AT^SMGSIMS](#).

Syntax

<p>Test Command</p> <p>AT+CMMS=?</p> <p>Response(s)</p> <p>+CMMS: (list of supported) <mode>s</p>	
<p>Read Command</p> <p>AT+CMMS?</p> <p>Response(s)</p> <p>+CMMS: <mode></p> <p>OK</p>	
<p>Write Command</p> <p>AT+CMMS=<mode></p> <p>Response(s)</p> <p>OK</p> <p>ERROR</p> <p>+CMS ERROR: <err></p>	
<p>PIN → Last</p> <p>+ + -</p>	<p>Reference(s)</p> <p>3GPP TS 27.005 [38]</p>

Parameter Description

<mode> ^(num)	
[0] ^(P)	Feature disabled.
1	Keep link open until the time between the response of the latest message send command (AT+CMGS , AT+CMSS , etc.) and the next send command exceeds 1-5 seconds. Afterwards UE will close the link and automatically switches <mode> back to 0.
2	Keep link open until the time between the response of the latest messages send command (AT+CMGS , AT+CMSS , etc.) and the next send command exceeds 1-5 seconds. Afterwards UE will close the link, but will not reset <mode> to 0.

11.10 AT+CMSS Send short messages from storage

The write command sends message with location value `<index>` from message storage `<mem2>` to the network (SMS-SUBMIT or SMS-COMMAND). If new recipient address `<da>` is given for SMS-SUBMIT, it shall be used instead of the one stored with the message. Reference value `<mr>` is returned to the TE on successful message delivery. Value can be used to identify message upon unsolicited delivery status report result code. If the optional parameter `<da>` is given, the old status of the short message at `<index>` remains unchanged (see `<stat>`).

Note: To send 3GPP2 SMS over IMS, consider using `AT^SMGSIMS`.

Syntax

Test Command AT+CMSS=? Response(s) OK	
Write Command If text mode (<code>AT+CMGF=1</code>): AT+CMSS= <code><index></code> [, <code><da></code> [, <code><toda></code>]] Response(s) +CMSS: <code><mr></code> [, <code><scts></code>] OK If sending fails ERROR +CMS ERROR: <code><err></code>	
Write Command If PDU mode (<code>AT+CMGF=0</code>): AT+CMSS= <code><index></code> [, <code><da></code> [, <code><toda></code>]] Response(s) +CMSS: <code><mr></code> [, <code><ackpdu></code>] OK If sending fails ERROR +CMS ERROR: <code><err></code>	
PIN → Last + - -	Reference(s) 3GPP TS 27.005 [38]

11.11 AT+CNMA New Message Acknowledgement to UE/TE

In SMS text mode ([AT+CMGF=1](#)) execute command confirms reception of a new message (SMS-DELIVER or SMS-STATUS-REPORT) which is routed directly to the TE. In PDU mode ([AT+CMGF=0](#)) write command is used to send either positive (RP-ACK) or negative (RP-ERROR) acknowledgement to the network. Parameter [<n>](#) defines which one will be sent.

ELS31-V will not send another "+CMT" or "+CDS" URC to the TE until previous one is acknowledged with this command. If the UE does not receive acknowledgement within required time (network timeout), it sends an "RP-ERROR" message to the network. The UE will automatically disable routing to the TE by setting both [<mt>](#) and [<ds>](#) values of [AT+CNMI](#) to zero.

Syntax

Test Command AT+CNMA=? Response(s) +CNMA: (list of supported <n> s) OK	
Exec Command AT+CNMA Response(s) OK ERROR +CMS ERROR: <err>	
Write Command AT+CNMA= <n> Response(s) OK ERROR +CMS ERROR: <err>	
PIN → Last + - -	Reference(s) 3GPP TS 27.005 [38]

Parameter Description

<n> ^(num)	
Parameter required only for PDU mode.	
0	Command operates similarly as in text mode.
1	Send positive (RP-ACK) acknowledgement to the network. Accepted only in PDU mode.
2	Send negative (RP-ERROR) acknowledgement to the network. Accepted only in PDU mode.

Notes

- Execute and write command shall only be used if [AT+CSMS](#) parameter [<service>](#) equals 1 (= phase 2+).
- Execute command can be used no matter whether text mode or PDU mode is activated. Write command is designed for the PDU mode only.

11.12 AT+CNMI SMS Event Reporting Configuration

AT+CNMI selects the procedure how the receipt of a new SMS from the network is indicated to the TE when TE is active. Please also consider general rules for URC signaling explained in Section 1.7, [Unsolicited Result Code Presentation](#) and in Section 2.11, [Extended Configuration Settings](#).

Changing **AT+CNMI** parameters on one of the UE's interfaces will automatically restore **AT+CNMI** default settings on all other interfaces. This ensures that incoming short messages are always indicated on the interface from which the **AT+CNMI** command was most recently issued.

The rules **<mt>=2** and **<mt>=3** for storing received messages are possible only if phase 2+ compatibility is activated with **AT+CSMS=1**. The parameter **<ds>=1** is only available in phase 2+.

Syntax

<p>Test Command</p> <pre>AT+CNMI=?</pre> <p>Response(s)</p> <pre>+CNMI: (list of supported<mode>s), (list of supported <mt>s), (list of supported <bm>s), (list of supported <ds>s), (list of supported <bfr>s) OK</pre>	
<p>Read Command</p> <pre>AT+CNMI?</pre> <p>Response(s)</p> <pre>+CNMI: <mode>, <mt>, <bm>, <ds>, <bfr> OK</pre>	
<p>Write Command</p> <pre>AT+CNMI=<mode>[, <mt>[, <bm>[, <ds>[, <bfr>]]]]</pre> <p>Response(s)</p> <pre>OK ERROR +CMS ERROR: <err></pre>	
<p>PIN → Last</p> <pre>+ + -</pre>	<p>Reference(s)</p> <p>3GPP TS 27.005 [38]</p>

Unsolicited Result Codes

URC 1

<mt>=1:

+CMTI: **<mem3>**, **<index>**

Indicates that new message has been received

URC 2

<mt>=2 (PDU mode enabled):

+CMT: [**<alpha>**], **<length>**<CR><LF><pdu>

Indicates that new message has been received

URC 3

<mt>=2 (text mode enabled):

+CMT: **<oa>**, [**<alpha>**], **<scts>**[, **<toa>**, **<fo>**, **<pid>**, **<dcs>**, **<sca>**, **<tosca>**, **<length>**] <CR><LF><data>

Indicates that new message has been received

URC 4

<ds>=1 (PDU mode enabled):

+CDS: <length><CR><LF><pdu>

Indicates that new SMS status report has been received

URC 5

<ds>=1 (text mode enabled):

+CDS: <fo>, <mr>[, <ra>] [, <tora>], <scts>, <dt>, <st>

Indicates that new SMS status report has been received

URC 6

<ds>=2:

+CDSI: <mem3>, <index>

Indicates that new SMS status report has been received

Parameter Description

<mode> ^{(num)(&V)(&W)}	
[0]	SMS related URCs are always buffered in the UE. If the buffer is full, the oldest indications are discarded and replaced with newly received indications.
1 ^{(&F)(P)}	SMS related URCs are forwarded directly to the TE. However, if this is not possible because UE-TE link is reserved, e.g. during a data call, these URCs are discarded.
2	SMS related URCs are forwarded directly to the TE. However, if this is not possible because UE-TE link is reserved these URCs are buffered and flushed to the TE afterwards.
<mt> ^{(num)(&V)(&W)}	
Rules for storing received short messages depend on the relevant data coding method (refer to 3GPP TS 23.038 [28]), preferred memory storage (AT+CPMS) setting and this value.	
[0] ^(P)	No SMS-DELIVER indications are routed to the TE.
1	Class 0 SMS-DELIVERs are routed directly to the TE via URC. For all other messages the following applies: If SMS-DELIVER is stored in UE, indication of the memory location is routed to the TE via URC.
2	SMS-DELIVERs, except class 2 messages and messages in the message waiting indication group (store message) are routed directly to the TE via URC.
3	Class 0 and 3 SMS-DELIVERs are routed directly to the TE via URCs defined for <mt>=2. Messages of other data coding schemes result in indication as defined for <mt>=1.
<bm> ^{(num)(&V)(&W)}	
Rules for handling of CBM. Feature not applicable to ELS31-V.	
[0] ^(P)	No CBM indications are routed to the TE.
<ds> ^{(num)(&V)(&W)}	
[0] ^(P)	No SMS-STATUS-REPORTs are routed to the TE.
1	SMS-STATUS-REPORTs are routed to the TE via URC.
2	If SMS-STATUS-REPORT is routed into UE, indication of the memory location is routed to the TE via URC.

<bfr>^{(num)&V}

[0] ^(P)	UE's buffer of SMS related URCs is flushed to the TE when <mode> changes from 0 to 1, 2 or 3.
1	UE's buffer of SMS related URCs is cleared when <mode> changes from 0 to 1, 2 or 3.

<index>^(num)

Integer type; value in the range of location numbers supported by the associated memory

Notes

- Parameters <mt>=2,3 and <ds>=1 are only available with GSM phase 2+ (see AT+CSMS=1). Incoming SMS or Status Reports have to be acknowledged with AT+CNMA=0 when using these phase 2+ parameters. If either a SM or a Status Report is not acknowledged, AT+CNMI parameters <mt>=2,3 and <ds>=1 will be set to zero as specified for AT+CNMA.
- Please note that parameters omitted in the write AT+CNMI command will be set to zero.

11.13 AT+CPMS Preferred SMS message storage

The write command selects memory storages [<mem1>](#), [<mem2>](#), [<mem3>](#) to be used for reading, writing, etc.

Syntax

Test Command

AT+CPMS=?

Response(s)

+CPMS: (list of supported [<mem1>s](#)), (list of supported [<mem2>s](#)), (list of supported [<mem3>s](#))
 OK

Read Command

AT+CPMS?

Response(s)

+CPMS: [<mem1>](#), [<used1>](#), [<total1>](#), [<mem2>](#), [<used2>](#), [<total2>](#), [<mem3>](#), [<used3>](#), [<total3>](#)
 OK
 ERROR
 +CMS ERROR: [<err>](#)

Write Command

AT+CPMS=[<mem1>](#)[, [<mem2>](#)[, [<mem3>](#)]]

Response(s)

+CPMS: [<used1>](#), [<total1>](#), [<used2>](#), [<total2>](#), [<used3>](#), [<total3>](#)
 OK
 ERROR
 +CMS ERROR: [<err>](#)

PIN → Last

+ + -

Reference(s)

3GPP TS 27.005 [38]

Parameter Description

[<used1>](#)^(num)

Number of messages currently in [<mem1>](#)

[<used2>](#)^(num)

Number of messages currently in [<mem2>](#)

[<used3>](#)^(num)

Number of messages currently in [<mem3>](#)

[<total1>](#)^(num)

Number of messages storable in [<mem1>](#)

[<total2>](#)^(num)

Number of messages storable in [<mem2>](#)

[<total3>](#)^(num)

Number of messages storable in [<mem3>](#)

Note

- The "ME" memory offers space for 10 short messages, see [<mem1>](#).

11.14 AT+CSCA SMS Service Center Address

The [AT+CSCA](#) write command updates the SMSC address, through which mobile originated SMS are transmitted. In text mode, setting is used by send and write commands. In PDU mode, setting is used by the same commands, but only when the length of the SMSC address coded into the [<pdu>](#) parameter equals zero.

Note: The service center address is not used in 3GPP2 SMS over IMS mode.

Syntax

Test Command	
AT+CSCA=?	
Response(s)	
OK	
Read Command	
AT+CSCA?	
Response(s)	
+CSCA: <sca> , <tosca>	
OK	
Write Command	
AT+CSCA= <sca> [, <tosca>]	
Response(s)	
OK	
PIN → Last	Reference(s)
+ + -	3GPP TS 27.005 [38]

Notes

- This command writes the service center address to non-volatile memory.
- The SMS service center address should be entered as specified by the service provider.

11.15 AT+CSDH Show SMS text mode parameters

The write command sets whether or not detailed header information is shown in text mode result codes.

Syntax

<p>Test Command</p> <p>AT+CSDH=?</p> <p>Response(s)</p> <p>+CSDH: (list of supported <show>s)</p> <p>OK</p>	
<p>Read Command</p> <p>AT+CSDH?</p> <p>Response(s)</p> <p>+CSDH: <show></p> <p>OK</p>	
<p>Write Command</p> <p>AT+CSDH=<show></p> <p>Response(s)</p> <p>OK</p>	
<p>PIN → Last</p> <p>- + -</p>	<p>Reference(s)</p> <p>3GPP TS 27.005 [38]</p>

Parameter Description

<show> ^{(num)(&W)}	
[0] ^{(&F)(D)}	Do not show header values defined in commands AT+CSCA and AT+CSMP (<sca>, <tosca>, <fo>, <vp>, <pid> and <dcs>) nor <length>, <toda> or <tooa> in "+CMT", AT+CMGL , AT+CMGR result codes for SMS-DELIVERs and SMS-SUBMITs in text mode; for SMS-COMMANDs in +CMGR result code, do not show <pid>, <mn>, <da>, <toda>, <length> or <cdata>
1	Show the values in result codes

11.16 AT+CSMP Set SMS Text Mode Parameters

AT+CSMP controls additional parameters needed when a short message is sent to the network or placed in a storage if text format message mode is selected.

It is possible to set the validity period starting from the time when the short message is received by the SMSC (**<vp>** is in the range 0... 255) or define an absolute time for validity period termination (**<vp>** is a string). The format of **<vp>** is given by **<fo>**. The enhanced validity period format is given as hexadecimal coded string (e.g. **<pdu>**) with quotes.

Note: To set data coding scheme in 3GPP2 SMS consider using **AT^SIMSCFGSMS**.

Syntax

<p>Test Command</p> <pre>AT+CSMP=?</pre> <p>Response(s)</p> <pre>OK</pre>	
<p>Read Command</p> <pre>AT+CSMP?</pre> <p>Response(s)</p> <pre>+CSMP: <fo>, <vp>/ <scts>, <pid>, <dcs></pre> <pre>OK</pre>	
<p>Write Command</p> <pre>AT+CSMP=<fo>[, <vp>/<scts>[, <pid>[, <dcs>]]]</pre> <p>Response(s)</p> <pre>OK</pre> <pre>ERROR</pre> <pre>+CMS ERROR: <err></pre>	
<p>PIN → Last</p> <pre>+ + -</pre>	<p>Reference(s)</p> <p>3GPP TS 27.005 [38]</p>

Parameter Description

<p><fo>^(num)</p> <p>First Octet</p> <p>Depending on the command or result code: First octet of 3GPP TS 23.040 [29] SMS-DELIVER, SMS-SUBMIT, SMS-STATUS-REPORT, or SMS-COMMAND in integer format.</p> <p>0...17^(P)...255</p>
<p><vp>^(num)</p> <p>Validity Period</p> <p>Depending on SMS-SUBMIT <fo> setting: 3GPP TS 23.040 [29] TP-Validity-Period either in integer format or in time-string format (refer <dt>).</p> <p>0...167^(P)...255</p>
<p><pid>^(num)</p> <p>Protocol Identifier</p> <p>3GPP TS 23.040 [29] TP-Protocol-Identifier in integer format.</p> <p>0^(P)...255</p>

<dcS>^(num)

Data Coding Scheme

3GPP TS 23.038 [28] SMS Data Coding Scheme, or Cell Broadcast Data Coding Scheme in integer format.

0^(P)...247

Notes

- When storing a SMS DELIVER from the TE to the preferred memory storage in text mode (using the [AT+CMGW](#) write command), <vp> field can be used for <scts>.
-

11.17 AT+CSMS Select Message Service

Syntax

<p>Test Command</p> <p>AT+CSMS=?</p> <p>Response(s)</p> <p>+CSMS: (list of supported<service>s)</p> <p>OK</p>	
<p>Read Command</p> <p>AT+CSMS?</p> <p>Response(s)</p> <p>+CSMS: <service>, <mt>, <mo>, <bm></p> <p>OK</p>	
<p>Write Command</p> <p>AT+CSMS=<service></p> <p>Response(s)</p> <p>+CSMS: <mt>, <mo>, <bm></p> <p>OK</p> <p>ERROR</p> <p>+CMS ERROR: <err></p>	
<p>PIN → Last</p> <p>+ + -</p>	<p>Reference(s)</p> <p>3GPP TS 27.005 [38]</p>

Parameter Description

<service> ^{(num)(&V)(&W)}	
0(&F)(D)	3GPP TS 23.040 [29] and 3GPP TS 23.041 [30] (the syntax of SMS AT commands is compatible with 3GPP TS 27.005 [38] Phase 2 version 4.7.0; Phase 2+ features which do not require new command syntax may be supported, e.g. correct routing of messages with new Phase 2+ data coding schemes)
1	3GPP TS 23.040 [29] and 3GPP TS 23.041 [30] (the syntax of SMS AT commands is compatible with 3GPP TS 27.005 [38] Phase 2+ version; the requirement of <service> setting 1 is mentioned under corresponding command descriptions).

<mt> ^{(num)(&V)}	
Mobile Terminated Messages:	
0	Type not supported
1(P)	Type supported

<mo> ^{(num)(&V)}	
Mobile Originated Messages:	
0	Type not supported
1(P)	Type supported

11.18 AT^SMGL List Short Messages from preferred store without setting status to REC READ

The write command allows to select a status type and lists, from the message storage `<mem1>`, all messages that currently have the specified `<stat>`. The major difference over the standard command `AT+CMGL` is that the status of the listed messages remains `unread` (unread remains unread).
The execute command is the same as the write command, but uses the given default of `<stat>`.

Note: To list 3GPP2 SMS over IMS, consider using `AT^SMGLIMS`.

Syntax

Test Command
AT^SMGL=?
Response(s)
same as AT+CMGL
Exec Command
AT^SMGL
Response(s)
^SMGL: (For default values of <code><stat></code> , see "Section 11.1, SMS Parameters .)
OK
Write Command
AT^SMGL= <code><stat></code>
Response(s)
same as AT+CMGL
PIN → Last
+ + -

Notes

- The selected `<mem1>` can contain different types of SMS (e.g. SMS-DELIVERs, SMS-SUBMITs and SMS-COMMANDs), the response may be a mix of the responses of different SM types. TE application can recognize the response format by examining the third response parameter.
- Users should be aware that when using this AT command quickly after SIM PIN authentication the SIM data may not yet be accessible, resulting in an error or a short delay before the requested AT command response is returned.

11.19 AT^SMGR Read short message without setting status to REC READ

The [AT^SMGR](#) command is a proprietary command which has the same syntax as [AT+CMGR](#). The only functional difference is that the status "REC UNREAD" of a short message is not overwritten to "REC READ".

Note: To read 3GPP2 SMS over IMS, consider using [AT^SMGRIMS](#).

Syntax

Test Command
AT^SMGR=?
Response(s)
OK
Write Command
AT^SMGR=<index>
Response(s)
see AT+CMGR
PIN → Last
+ + -

Note

- Users should be aware that when using this AT command quickly after SIM PIN authentication the SIM data may not yet be accessible, resulting in a short delay before the requested AT command response is returned.

OK

^SMGSIMS: SENT OK, 6, 1

^SMGSIMS: SENT OK, 7, 2

^SMGSIMS: ACK OK, 6

^SMGSIMS: ACK OK, 7

11.21 AT^SMGRIMS Read 3GPP2 SMS over IMS

The AT^SMGRIMS write command reads a 3GPP2 short short message specified with <index> from the preferred message storage <mem1>. If the message is segmented, it performs an automatic reconstruction of the full message from available segments in the storage.

Syntax

Write Command

```
AT^SMGRIMS=<index>
```

Response(s)

```
^SMGRIMS: <stat>, <sendStat>, <oa>, <scts>, <localTS>, <priority>, <CbkNumber><CR><LF>,  
<data>  
OK  
ERROR  
+CME ERROR: <err>
```

PIN → Last

```
- - -
```

Example

Example: Reading 3GPP2 message at <index> 2:

```
AT^SMGRIMS=2  
^SMGRIMS: "REC READ", "UNUSED", "5714550728"  
"15/09/17,03:48:20+00", "15/09/17,18:16:21+00", 2, "222222222"  
Test msg to check Priority and Call-Back  
  
OK
```

11.22 AT^SMGLIMS List 3GPP2 SMS over IMS

The `AT^SMGLIMS` execute command returns the indexes of all stored 3GPPs short messages. For segmented messages, it returns only one index (the one of its first segment).

Syntax

```
Exec Command
AT^SMGLIMS
Response(s)
^SMGRIMS: <index>[, <index>[, <index>]]
OK
ERROR
+CME ERROR: <err>
```

PIN → Last

- - -

Example

Example: In the following example, 7 SMS fragments (#0 to #6) are in memory, and the last 3 belong to the same SMS (fragments #4, #5 and #6).

```
AT^SMGLIMS
^SMGLIMS: 0,1,2,3,4
OK
```

11.23 AT^SMGDIMS Delete 3GPP2 SMS over IMS

The `AT^SMGDIMS` write command deletes a 3GPP2 short message specified with `<index>` from the preferred message storage. If the message is segmented, all its segments are deleted.

Syntax

Test Command

```
AT^SMGDIMS=?
```

Response(s)

```
OK
```

Write Command

```
AT^SMGDIMS=<index>
```

Response(s)

```
OK
```

```
ERROR
```

```
+CME ERROR: <err>
```

PIN → Last

```
- + -
```

Note

- If there is no short message stored at the selected index, the response is "+CMS ERROR: invalid memory index".

Example

Example: Deleting 3GPP2 short message at `<index>` 2:

```
AT^SMGDIMS=2
```

```
OK
```

11.24 AT^SIMSCFGSMS Configure 3GPP2 SMS over IMS

The `AT^SIMSCFGSMS` write command specifies parameters of 3GPP2 SMS over IMS. The settings apply only to MO messages.

Syntax

Test Command

```
AT^SIMSCFGSMS=?
```

Response(s)

```
^SIMSCFGSMS: (list of supported<moType>s), (list of supported <moCharSet>s), (list of supported <moAckReq>s)
```

```
OK
```

Read Command

```
AT^SIMSCFGSMS?
```

Response(s)

```
^SIMSCFGSMS: <moType>, <moCharSet>, <moAckReq>
```

```
OK
```

Write Command

```
AT^SIMSCFGSMS=<moType>[, <moCharSet>[, <moAckReq>]]
```

Response(s)

```
^SIMSCFGSMS: <moType>, <moCharSet>, <moAckReq>
```

```
OK
```

```
ERROR
```

```
+CME ERROR: <err>
```

PIN → Last

```
- - -
```

Parameter Description

`<moType>`^(str)

Format of the MO short message.

"3GPP"	3GPP format
"3GPP2" ^(P)	3GPP2 format (CDMA)

`<moCharSet>`^(str)

Force the text encoding of MO short message.

"AUTO" ^(P)	Encoding is auto-selected (depends on used symbols)
"ASCII"	7 bit ASCII
"GSM"	7 bit GSM
"IA5"	7 bit IA5
"LATIN1"	8 bit LATIN
"UCS2"	UCS2

<moAckReq>^(num)

Send TP-SRR(3GPP) or BearerReplyOption(3GPP2).

0 ^(P)	Do not request
1	Do request

Note

- <moCharSet> parameter is allowed only when <moType>= "3GPP2".
If <moType>= "3GPP", then <moCharSet> parameter is not accepted.

12. (U)SIM related Commands

12. (U)SIM related Commands

AT commands described in this chapter are related to the Subscriber Identity Module ((U)SIM) connected to the ELS31-V.

12.1 AT+CCID (U)SIM Card Identification Number

AT+CCID serves to query the (U)SIM card identification number. This information is retrieved from (U)SIM Elementary File EF_{ICCID} and the Elementary File EF_{eUICCID}. For details refer to 3GPP TS 11.11 [10], 3GPP TS 31.101 [11], 3GPP TS 31.102 [12].

Syntax

Test Command
AT+CCID=?
Response(s)
OK
Read Command
AT+CCID?
Response(s)
+CCID: <ICCID>, <eUICCID>
OK
ERROR
+CME ERROR: <err>
Exec Command
AT+CCID
Response(s)
+CCID: <ICCID>, <eUICCID>
OK
ERROR
+CME ERROR: <err>
PIN → Last
- + -

Parameter Description

<ICCID>^(str)

ICCID (Integrated Circuit Card ID) of the (U)SIM card

<eUICCID>^(str)

eUICCID (Embedded Universal Integrated Circuit Card ID) of the (U)SIM card

The UE reads the eUICCID in the following order:

1. eUICC ID represented as the concatenation of the SIN (Security Domain Provider Identification Number) and SDIN (Security Domain Image Number) as defined in the "GlobalPlatform Card Specification".
2. If method 1 is not available, and especially for older (U)SIM cards the eUICC ID is possibly contained in the following Elementary Files which are checked in the order:

-
- (U)SIM Elementary File EF_{eUICCID} (residing in master file directory, file ID 0x2FC8)
 - (U)SIM Elementary File EF_{eUICCID} (residing in master file directory, file ID 0x0099)

If no eUICCID is available or the SIM card is removed (physically or logically) [AT+CCID](#) returns an empty string "".

12.2 AT+CRSM Restricted SIM Access

AT+CRSM offers easy access of the Elementary Files on the (U)SIM. Access to the (U)SIM database is restricted to the commands which are listed at [<command>](#).

All parameters of AT+CRSM are used as specified by 3GPP TS 11.11 [10], 3GPP TS 31.101 [11], 3GPP TS 31.102 [12]. ELS31-V handles internally all required (U)SIM interface locking and file selection routines.

As response to the command, the ELS31-V sends the actual (U)SIM information parameters and response data. Error result code "+CME ERROR" may be returned if the command cannot be passed to the (U)SIM, e.g. if the (U)SIM is not inserted. However, failure in the execution of the command in the (U)SIM is reported in [<sw1>](#) and [<sw2>](#) parameters.

Syntax

<p>Test Command</p> <pre>AT+CRSM=?</pre> <p>Response(s)</p> <pre>OK</pre>	
<p>Write Command</p> <pre>AT+CRSM=<command>[, <fileID>[, <P1>, <P2>, <P3>[, <data>][, <pathId>]]]</pre> <p>Response(s)</p> <pre>+CRSM: <sw1>,<sw2>[,<response>] OK ERROR +CME ERROR: <err></pre>	
<p>PIN → Last</p> <pre>- + -</pre>	<p>Reference(s)</p> <p>3GPP TS 27.007 [39], 3GPP TS 11.11 [10], 3GPP TS 31.101 [11], 3GPP TS 31.102 [12]</p>

Parameter Description

<command>^(num)	
(U)SIM command number.	
176	READ BINARY
178	READ RECORD
192	GET RESPONSE
214	UPDATE BINARY
220	UPDATE RECORD
242	STATUS
<fileID>^(num)	
Identifier for an elementary data file on (U)SIM, if used by <command> . Mandatory for every command except STATUS.	
<P1>^(num)	
Parameter to be passed on by the ELS31-V to the (U)SIM.	
0...255	

<P2>^(num)

Parameter to be passed on by the ELS31-V to the (U)SIM.

0...255

<P3>^(num)

Parameter to be passed on by the ELS31-V to the (U)SIM.

0...255

<data>^(str)

Information which shall be written to the (U)SIM (hexadecimal character format).

<pathId>^(str)

Contains the directory path of an elementary file on the UICC in hexadecimal format (e.g. "7F105F50").

<sw1>^(num)

Status information from the (U)SIM about the execution of the actual command. It is returned in both cases, on successful or failed execution of the command.

0...255

<sw2>^(num)

Status information from the (U)SIM about the execution of the actual command. It is returned in both cases, on successful or failed execution of the command.

0...255

<response>^(str)

Response data in case of a successful completion of the previously issued command. "STATUS" and "GET RESPONSE" commands return data, which gives information about the currently selected elementary data field. This information includes the type of file and its size.

After "READ BINARY" or "READ RECORD" commands the requested data will be returned.

<response> is empty after "UPDATE BINARY" or "UPDATE RECORD" commands.

12.3 AT+CSIM Generic (U)SIM Access

AT+CSIM allows direct control of the (U)SIM.

Compared to Restricted (U)SIM Access command **AT+CRSM**, the definition of **AT+CSIM** allows the UE to take more control over the (U)SIM interface.

For parameter and (U)SIM result coding please refer to 3GPP TS 11.11 [10], 3GPP TS 31.101 [11], 3GPP TS 31.102 [12].

However, only the following (U)SIM commands are fully supported by **AT+CSIM**: SELECT, STATUS, READ BINARY, UPDATE BINARY, READ RECORD, UPDATE RECORD, SEEK, INCREASE and GET RESPONSE. Other (U)SIM commands will work in conjunction with the (U)SIM but the correct interaction of the (U)SIM with the ELS31-V is not guaranteed.

Syntax

Test Command AT+CSIM=? Response(s) OK	
Write Command AT+CSIM=<length>, <command> Response(s) +CSIM: <length>,<response> OK ERROR +CME ERROR: <err>	
PIN → Last - + -	Reference(s) 3GPP TS 27.007 [39], 3GPP TS 11.11 [10], 3GPP TS 31.101 [11], 3GPP TS 31.102 [12]

Parameter Description

<length> ^(num)	Number of characters of <command> or <response> string.
<command> ^(str)	Command passed on by the UE to the (U)SIM.
<response> ^(str)	Response data of the command returned by the (U)SIM.

13. (U)SIM Application Toolkit (SAT) Commands

This chapter describes AT commands and responses related to the ELS31-V's [SIM Application Toolkit \(SAT\)](#) implementation.

[SAT](#) is a technology that allows an application running on the (U)SIM to control the LTE Engine (UE); it is specified in 3GPP TS 11.14 [14], 3GPP TS 31.111 [15], ETSI TS 102 223 [16].

[Remote SIM Application Toolkit](#), or short [Remote-SAT](#), provides a link between an application running on the (U)SIM and the Customer Application (TE). The purpose of [Remote-SAT](#) is to allow the TE to send AT commands to the [SAT](#) interface and to display dedicated [SAT](#) activity on the user interface of the TE. The overall scenario is illustrated in the context diagram below.

Following types of data are exchanged between the ELS31-V and the application running on the (U)SIM:

- Proactive commands (PACs) are sent from the (U)SIM application to the UE. Some PAC types are executed by the UE itself, comparable with AT commands. Other PAC types are immediately forwarded to the TE, e.g. "DISPLAY TEXT".
- Terminal Response is the UE's answer to the last PAC, sometimes to be provided by the TE.
- Envelope commands are sent from the UE or TE to the (U)SIM Application, such as "MENU SELECTION".

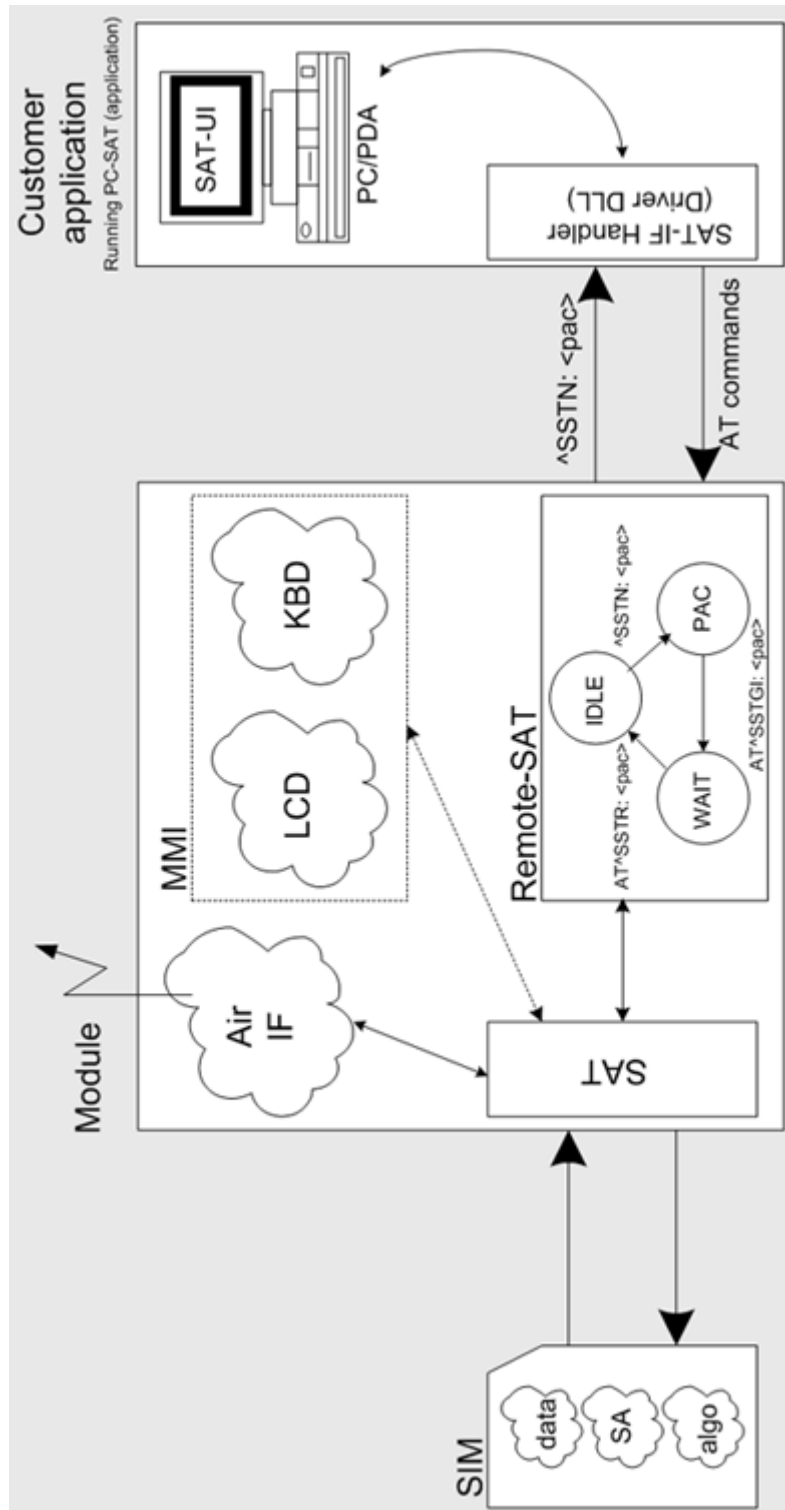

Figure 13.1: Remote-SAT Context Diagram

13.1 AT^SSTA Remote-SAT Interface Activation

AT^SSTA write command can be used to determine the Remote-SAT activation mode <mode> and, if Explicit Response mode is enabled, to activate the Remote-SAT interface. Removing and inserting the SIM does not affect the activation status.

SAT commands which are not using the AT interface (non-MMI related SAT commands, e.g. PROVIDE LOCAL INFORMATION) are executed without activating Remote-SAT.

The read command can be used to request the current operating status and the used alphabet of the Remote-SAT interface.

Syntax

```

Test Command
AT^SSTA=?
Response(s)
^SSTA: (list of supported <state>s), (list of supported <Alphabet>s)
OK

Read Command
AT^SSTA?
Response(s)
^SSTA: <state>, <Alphabet>, <allowedInstance>, <SatProfile>, <userTOut>, <AppType>
OK

Write Command
AT^SSTA=<mode>[, <Alphabet>]
Response(s)
OK
    
```

PIN → Last
 - + -

Parameter Description

<state> ^(num)	
UE Remote-SAT interface states	
1	OFF
2	IDLE
<Alphabet> ^{(num)(NV)}	
Setting becomes effective after restarting the UE.	
0 ^(D)	GSM character set Input of a character requests one byte, e.g. "Y".
1	UCS2 To display the 16 bit value of characters represented in UCS2 alphabet a 4 byte string is required, e.g. "0059" is coding the character "Y". For details please refer to ISO/IEC 10646.

<allowedInstance>^(num)

Remote-SAT handling (i.e. [AT+STKPRO](#) URC and [AT+STKTR](#) sequence) is only usable via the channel on which the Explicit Response (ER) mode was activated.

To change the serial channel execute [AT^SSTA=1](#) on the desired channel and perform a restart.

- | | |
|---|--|
| 0 | SAT is already used on another instance. |
| 1 | SAT may be started on this instance via the write version of this command. |

<SatProfile>^(str)

SAT Terminal Profile according to 3GPP TS 11.14 [\[14\]](#), 3GPP TS 31.111 [\[15\]](#), ETSI TS 102 223 [\[16\]](#).

The profile tells the SIM Application which features (e.g. Proactive Commands) are supported by the SIM Application Toolkit implementation of the UE.

<userTOut>^(num)

PAC user timeout in seconds.
This parameter is not applicable.

<AppType>^(num)

SIM Application type.

This parameter shows the type of SIM application currently running.

- | | |
|---|-----------------------|
| 0 | (U)SIM not inserted |
| 1 | 2G Application (SAT) |
| 2 | 3G Application (USAT) |

<mode>^{(num)(NV)}

Select Remote-SAT activation mode.

Setting becomes effective after restarting the UE. Removing and inserting the SIM does not affect the activation status.

- | | |
|------------------|--|
| 0 ^(D) | Automatic Response (AR) mode.
All commands and responses are exchanged automatically between the UE and the SIM application. This eliminates the need to enter any Remote-SAT commands including the AT^SSTA command.
If AR mode is enabled the UE enters the OFF state (<state>=1) after restart. |
| 1 | Explicit Response (ER) mode.
This mode is intended for use with an MMI. If ER mode is enabled the MMI is required to handle, via UE's Remote-SAT interface, all commands and responses transmitted to or from the SIM or USIM.
If ER mode is enabled the UE enters the IDLE state (<state>=2) after reboot. |

13.2 AT+STKPRO SAT Proactive Command URCs

The [AT+STKPRO](#) test command returns the set of proactive commands supported. For each proactive command there is a URC provided.

Syntax

```
Test Command
AT+STKPRO=?
Response(s)
+STKPRO: (list of supported <ProactCmd>s)
OK
```

PIN → Last
- + -

Unsolicited Result Codes

URC 1

Refresh

+STKPRO: 01, <CmdQualifier>

URC 2

Set up event list

+STKPRO: 05, <EventList>

URC 3

Send SMS

+STKPRO: 19, <Alpha>, <IconId>, <RefNumber>

URC 4

Launch browser

+STKPRO: 21, <Url>, <Alpha>, <IconId>

URC 5

Play tone

+STKPRO: 32, <Tone>, <TimeUnit>, <Interval>, <Alpha>, <IconId>

URC 6

Display text

+STKPRO: 33, <CmdQualifier>, <Dcs>, <HexString>, <IconId>

URC 7

Get inkey

+STKPRO: 34, <CmdQualifier>, <Dcs>, <HexString>, <IconId>

URC 8

Get input

+STKPRO: 35, <CmdQualifier>, <Dcs>, <HexString>, <MaxRespLen>, <MinRespLen>, <DefaultText>, <IconId>

URC 9

Select item

+STKPRO: 36, <CmdQualifier>, <Alpha>, <ItemId>, <TotalItems>, <ItemText>, <NextAction>, <DefaultItem>, <IconId>, <IconIdListElem>

URC 10

Set up menu

+STKPRO: 37, <CmdQualifier>, <Alpha>, <ItemId>, <TotalItems>, <ItemText>, <NextAction>, <IconId>, <IconIdListElem>

URC 11

Provide local information

+STKPRO: 38, <CmdQualifier>

URC 12

Set up idle mode text

+STKPRO: 40, <Dcs>, <HexString>, <IconId>

URC 13

Run AT cmd info

+STKPRO: 52, <CmdQualifier>, <Alpha>, <IconId>, <AtCommand>

URC 14

Language notification

+STKPRO: 53, <Lang>

Parameter Description

<ProactCmd>^(num)

Proactive command

01	Refresh
05	Set up event list
19	Send SMS
21	Launch browser (currently not supported by ELS31-V)
32	Play tone
33	Display text
34	Get inkey
35	Get input
36	Select item
37	Set up menu
38	Provide local information
40	Set up idle mode text
52	Run AT cmd info
53	Language notification

<CmdQualifier>^(num)

Command qualifier. See 3GPP TS 11.14 [14], 3GPP TS 31.111 [15], ETSI TS 102 223 [16].

<Lang>^(num)

2 byte string indicating the language

<EventList>^(num)

04	User activity event
05	Idle screen available event
07	Language selection
08	Browser Termination event

<DialNumber>^(num)

Called party number

<Subaddr>^(num)

Called party subaddress

<Alpha>^(str)

Text string

<Alpha1>^(str)

Text string

<Alpha2>^(str)

Text string

<IconId>^(num)

Icon Identifier

<IconId1>^(num)

Icon Identifier

<IconId2>^(num)

Icon Identifier

<IconIdListElem>^(num)

Icon ID list element

<SsData>^(str)

Data string

<RefNumber>^(num)

Reference number

<Tone>^(num)

01	Dial tone
02	Call subscriber busy

03	Congestion
04	Radio path acknowledge
05	Radio path not available
06	Error / special information
07	Call waiting tone
08	Ringing tone
10	General beep
11	Positive acknowledgement tone
12	Negative acknowledgement or error tone

<Interval>^(num)

Time duration in number of time units

0	Indicates a non-existing duration object
1...255	Multiples of <TimeUnit>

<TimeUnit>^(num)

0	Minutes
1	Seconds
2	Tenth of seconds

<IdleInterval>^(num)

Defines the duration when an idle connection is released automatically. If not present, the UE never shall release a connection automatically.

0	Indicates a non-existing duration object
1...255	Multiples of <IdleUnit>

<IdleUnit>^(num)

0	Minutes
1	Seconds
2	Tenth of seconds

<ReconInterval>^(num)

A duration for reconnect tries. The interval specifies the time interval of the duration in multiples of the reconnect time unit used.

0	Indicates a non-existing duration object
1...255	Multiples of <ReconTimeUnit>

<ReconTimeUnit>^(num)

0	Minutes
1	Seconds
2	Tenth of seconds

<TotalItems>^(num)

Total items

<ItemId>^(num)

Item identifier (see 3GPP TS 11.14 [14], 3GPP TS 31.111 [15], ETSI TS 102 223 [16])

<ItemText>^(num)

Item text string

<Url>^(str)

URL that shall be loaded

<DefaultText>^(str)

Text string

<DefaultItem>^(str)

Default item, see <ItemId>

<Dcs>^(str)

Data coding scheme

<HexString>^(str)

String containing data in hexadecimal format

<MaxRespLen>^(num)

Maximum response length

<MinRespLen>^(num)

Minimum response length

<NextAction>^(num)

Next action

<AtCommand>^(str)

AT command requested by the (U)SIM

<BearerType>^(num)

1	Circuit switched
2	Packet switched
3	Default bearer
255	Invalid

<BearerParam>^(num)

Hex string containing detailed information dependent on the type.

<BufSize>^(num)

The buffer the TE shall allocate for channel data.

<LoginDcs>^(str)

Data coding scheme of the text string. Text strings may be coded in 7-bit, 8-bit or UCS2 (16-bit) for user authentication data if requested by the bearer connection.

<LoginText>^(str)

Specifies user authentication data if requested by the bearer connection. Coding based on <LoginDcs>.

<PasswordDcs>^(str)

Data coding scheme of the text string. Text strings may be coded in 7-bit, 8-bit or UCS2 (16-bit) for user authentication data if requested by the bearer connection.

<PasswordText>^(str)

Specifies user authentication data if requested by the bearer connection. Coding based on <PasswordDcs>.

<TransportLevel>^(num)

Specifies the transport layer protocol of the UICC/TE connection.

1	UDP (as defined in RFC 768 [9])
2	TCP (as defined in RFC 793 [10])
255	No transport protocol specified

<TransportPort>^(num)

Specifies the port number.

<SubaddrCs>^(num)

Called party subaddress for CS bearers only

<DestAddrType>^(num)

Type of destination address

33	IPv4 address
2	IPv6 address
255	Invalid

<DestAddr>^(str)

Specifies the destination point of the connection. Hex string.

13.3 AT+STKTR SAT Terminal Response Commands

Each **AT+STKTR** write command allows entering the response to a SAT proactive command which was displayed by the URC +STKPRO.

The **AT+STKTR** test command returns the list or proactive commands (see [<ProactCmd>](#) of **AT+STKPRO**).

Note: Value 0 in some of the commands specified below stands for parameter "last command" which is obsolete, but not removed so far.

For the general [<Result>](#)s 32, 33, 38, 52, 53, 55, 57 and 58, it is mandatory for the UE to provide a specific cause value by using the [<AddResult>](#) parameter (additional information). For others additional information will be ignored.

Syntax

Test Command

```
AT+STKTR=?
```

Response(s)

```
+STKTR : (list of supported <ProactCmd>s)
```

```
OK
```

Write Command

Refresh

```
AT+STKTR=01,<Result> [, <AddResult>]
```

Response(s)

```
OK
```

```
ERROR
```

```
+CME ERROR: <err>
```

Write Command

Set up event list

```
AT+STKTR=05,<Result>
```

Response(s)

```
OK
```

```
ERROR
```

```
+CME ERROR: <err>
```

Write Command

Send SMS

```
AT+STKTR=19,<Result> [, <AddResult>]
```

Response(s)

```
OK
```

```
ERROR
```

```
+CME ERROR: <err>
```

Write Command

Launch browser

```
AT+STKTR=21,<Result>
```

Response(s)

```
OK
```

```
ERROR
```

```
+CME ERROR: <err>
```

Write Command

Play tone

AT+STKTR=32,<Result>[, <AddResult>]

Response(s)

OK

ERROR

+CME ERROR: <err>

Write Command

Display text

AT+STKTR=33,<Result>[, <AddResult>]

Response(s)

OK

ERROR

+CME ERROR: <err>

Write Command

Get inkey

AT+STKTR=34,<Result>, <AddResult>, 0, <Dcs>, <HexString>

Response(s)

OK

ERROR

+CME ERROR: <err>

Write Command

Get input

AT+STKTR=35,<Result>, <AddResult>, 0, <Dcs>, <HexString>

Response(s)

OK

ERROR

+CME ERROR: <err>

Write Command

Select item

AT+STKTR=36,<Result>[, <AddResult>], <ItemId>

Response(s)

OK

ERROR

+CME ERROR: <err>

Write Command

Set up menu

AT+STKTR=37,<Result>[, <AddResult>]

Response(s)

OK

ERROR

+CME ERROR: <err>

Write Command

Provide local information (generic)

AT+STKTR=38,<Result>, <AddResult>

Response(s)

OK

Write Command (Continued)

Provide local information (generic)

AT+STKTR=38,<Result>, <AddResult>

Response(s)

ERROR

+CME ERROR: <err>

Write Command

Provide local information: Set language

AT+STKTR=38,<Result>, <Lang>

Response(s)

OK

ERROR

+CME ERROR: <err>

Write Command

Set up idle mode text

AT+STKTR=40,<Result>[, <AddResult>]

Response(s)

OK

ERROR

+CME ERROR: <err>

Write Command

Run AT command info

AT+STKTR=52,<Result>, <AddResult>, 0, <Dcs>, <AtcResponse>

Response(s)

OK

ERROR

+CME ERROR: <err>

Write Command

Language notification

AT+STKTR=53,<Result>, <Lang>

Response(s)

OK

ERROR

+CME ERROR: <err>

PIN → Last

± + -

Parameter Description

<ProactCmd>^(num)

Decimal code that specifies the proactive command. See [AT+STKPRO](#).

<Result>^(num)

Result indicated as decimal code

0	Command performed successfully
1	Command performed with partial comprehension

2	Command performed with missing information
3	REFRESH performed with additional Efs read
4	Command performed successfully, but requested icon could not be displayed
5	Command performed but modified by call control by SIM
6	Command performed successfully, limited service
7	Launch browser
16	Proactive SIM session terminated by the user
17	Backward move in the proactive SIM session requested by the user
18	No response from user
19	Help information required by the user
20	USSD or SS transaction terminated by the user
32	UE currently unable to process command
33	Network currently unable to process the command
34	User did not accept call set-up request
35	User cleared down call before connection or network release
36	Action in contradiction with the current timer state
37	Interaction with call control by SIM, temporary problem
38	Launch browser generic error code
48	Command beyond UE's capabilities
49	Command type not understood by UE
50	Command data not understood by UE
51	Command number not known by UE
52	SS return error
53	SMS RP-ERROR
54	Error, required values are missing
55	USSD return error
57	Interaction with call control by SIM or MO short message control by SIM, permanent problem
58	Bearer independent protocol error (if class "e" is supported)

<AddResult>^(num)

Additional result

1...255 See 3GPP TS 11.14 [14], 3GPP TS 31.111 [15], ETSI TS 102 223 [16].

<ItemId>^(num)

Item identifier (see 3GPP TS 11.14 [14], 3GPP TS 31.111 [15], ETSI TS 102 223 [16])

<Dcs>^(num)

Data Coding scheme. See 3GPP TS 23.038 [28].

<HexString>^(str)

String in hexadecimal format

<Lang>^(num)

Language given as integer (e.g. 28261 = English)

<AtcResponse>^(str)

AT command response sent from UE to (U)SIM in hexadecimal format

13.4 AT+STKENV SAT Envelope Command

AT+STKENV allows to send an envelope command from the UE or TE to the (U)SIM Application.

Syntax

Test Command

AT+STKENV=?

Response(s)

+STKENV : (list of supported <EnvCmd>s)

OK

Write Command

Menu Selection

AT+STKENV=211,<ItemId>[, <Help>]

Response(s)

OK

ERROR

+CME ERROR: <err>

Write Command

Event download

AT+STKENV=214,<Event>[, <Cause>]

Response(s)

OK

ERROR

+CME ERROR: <err>

PIN → Last

± + -

Parameter Description

<EnvCmd>^(num)

Decimal code that specifies the envelope command.

211	Menu selection
214	Event download

<ItemId>^(num)

Item identifier

<Cause>^(num)

Optional parameter for <Event>= 08 Browser termination

0	User termination
1	Error termination

<Help>^(num)

Optional parameter for <EnvCmd> 211

0	Help is requested
1	Help is not requested

<Event>^(num)

04	User activity event
05	Idle screen available event
07	Language selection
08	Browser termination event (currently not supported by ELS31-V)

13.5 AT+STKCC SAT Call Control Notification

The +STKCC URC reports the status call control activities:

Unsolicited Result Codes

URC 1

Reported activity: Send Supplementary Service command

+STKCC: 2, <ResVal>, <Alpha>, <SsCode>

URC 2

Reported activity: Send USSD command

+STKCC: 3, <ResVal>, <Alpha>, <UssdCode>

URC 3

Reported activity: Send short message

+STKCC: 4, <ResVal>, <Alpha>, <ToSca>, <Sca>, <ToRa>, <Ra>

Parameter Description

<ResVal>^(num)

Call control result value

0	Allowed
1	Not allowed
2	Allowed, with modification
254	SAT busy (status word SW=x9300)

<Alpha>^(num)

Optional information provided by the (U)SIM as text string

<SsCode>^(str)

Supplementary Service code

<UssdCode>^(str)

USSD code

<ToSca>^(num)

0...255 Type of number (ton) and numbering plan identifier (npi) of Service Center address, e.g. 129 for national number, 145 for international number

<Sca>^(num)

Service Center Address

<ToRa>^(num)

0...255 Type of number (ton) and numbering plan identifier (npi) of Recipient address, e.g. 129 for national number, 145 for international number

<Ra>^(str)

Recipient Address

13.6 AT+STKCNF SAT Proactive Session Status

The status of the SAT proactive session is shown by unsolicited result code:

Unsolicited Result Code

+STKCNF: <ProactCmd>, <Result>, <AddResult>, <Sw1>

Parameter Description

<ProactCmd>^(num)

Decimal code that specifies the proactive command. Same as list provided by [AT+STKPRO](#) plus value 129.

01	Refresh
05	Set up event list
19	Send SMS
21	Launch browser (currently not supported by ELS31-V)
32	Play tone
33	Display text
34	Get inkey
35	Get input
36	Select item
37	Set up menu
38	Provide local information
40	Set up idle mode text
52	Run AT cmd info
53	Language notification
129	End of proactive session

<Result>^(num)

General result indicated as decimal code. See [AT+STKTR](#)

<AddResult>^(num)

Additional result

1...255 See 3GPP TS 11.14 [14], 3GPP TS 31.111 [15], ETSI TS 102 223 [16].

<Sw1>^(num)

Status word indicated as decimal code. Provides information from the (U)SIM about the execution of the last command. See 3GPP TS 11.11 [10] for list and description of possible values.

0...255	
0	Command to (U)SIM was suppressed.
144	Last command successfully executed and SAT cycle finished. No further PAC required. 144 = HEX 0x90.
145	Last command successfully executed. SAT cycle not yet finished. Next PAC is required. 145 = HEX 0x91.

13.7 Examples of how to Configure and Use the SAT

Below you can find selective examples of how to configure and use the SAT Toolkit if Explicit Response (ER) mode is enabled with `AT^SSTA`.

Examples

EXAMPLE 1

<code>AT^SSTA=1</code>	Set Explicit Response (ER) mode.
<code>OK</code>	
<code>AT^SMSO</code>	Switch off and restart the UE to make the change take effect.
<code>^SMSO: MS OFF</code>	
<code>OK</code>	
<code>^SHUTDOWN</code>	
<code>^SYSSTART</code>	
<code>AT+CPIN="1234"</code>	Entering SIM PIN.
<code>OK</code>	

EXAMPLE 2

SET UP MENU

<code>+STKPRO: 37,0,"Special",1,3,"News",0,0,0</code>	+STKPRO URC displays menu structure.
<code>+STKPRO: 37,0,"Special",2,3,"EMail",0,0,0</code>	
<code>+STKPRO: 37,0,"Special",3,3,"Bank-</code>	
<code>ing",0,0,0</code>	
<code>AT+STKTR=37,0</code>	Sending terminal response command for PAC 37.
<code>OK</code>	
<code>+STKCNF: 37,0,255,144</code>	+STKCNF URC confirms that command was successfully executed and SAT cycle has finished. No further PAC required.
<code>AT+STKENV=211,2</code>	Sending envelope command for selecting "EMail" option.
<code>OK</code>	
<code>+STKCNF: 129, 0, 255, 144</code>	+STKCNF URC indicates end of proactive session, confirms that last command was successfully executed and SAT cycle has finished. No further PAC required.

EXAMPLE 3

DISPLAY TEXT

<code>+STKPRO:</code>	+STKPRO URC indicates that PAC = 33 (Display text) is received. The sample text given in hexadecimal format means "Toolkit Test 1".
<code>33,128,4,"546F6F6C6B697420546573742031",0</code>	
<code>AT+STKTR=33,0</code>	Sending terminal response command for PAC 33.
<code>OK</code>	
<code>+STKCNF: 33,0,255,144</code>	+STKCNF URC confirms that command was successfully executed and SAT cycle has finished. No further PAC required.

EXAMPLE 4

GET INKEY

<code>+STKPRO: 34,0,4,"456E7465722022B22",0</code>	+STKPRO URC indicates that PAC = 34 (Get inkey) is received. The text given in hexadecimal format means that "Enter +" is requested.
<code>AT+STKTR=34,0,0,0,4,"2B"</code>	Terminal response command for PAC 34 is sending "+" as HEX string "2B".

```
OK
+STKCNF: 34,0,255,144
```

+STKCNF URC confirms that command was successfully executed and SAT cycle has finished. No further PAC required.

EXAMPLE 5

GET INPUT

```
+STKPRO:
35,0,4,"456E746572203132333435",5,5,"",0
```

+STKPRO URC indicates that PAC = 35 (Get input) is received. The text given in hexadecimal format means that "Enter 12345" is requested.

```
AT+STKTR=35,0,0,0,4,"3132333435"
```

Terminal response command for PAC 35 is sending "12345" as HEX string "3132333435".

```
OK
+STKCNF: 34,0,255,144
```

+STKCNF URC confirms that command was successfully executed and SAT cycle has finished. No further PAC required.

14. Phonebook Commands

The AT commands described in this chapter allow the external application to access the phonebooks located in the ELS31-V's memory or on the attached Subscriber Identity Module (SIM).

14.1 AT+CNUM Read own numbers

[AT+CNUM](#) returns the subscribers own number(s) from the SIM.

Syntax

Test Command	
AT+CNUM=?	
Response(s)	
OK	
Exec Command	
AT+CNUM	
Response(s)	
[+CNUM: [<alpha>], <number> , <type>]	
[+CNUM: ...]	
OK	
ERROR	
+CME ERROR: <err>	
PIN → Last	Reference(s)
+ + -	3GPP TS 27.007 [39]

Parameter Description

<alpha> ^(str)
Optional alphanumeric string associated with <number> .
<number> ^(str)
Phone number in format specified by <type> .
<type> ^(str)
Type of address octet.

15. Miscellaneous Commands

The AT Commands described in this chapter are related to various areas.

15.1 A/ Repeat Previous Command Line

Repeat previous AT command line.

In general, after beginning a command line with character "a" or "A" a second character "t", "T" or "/" has to follow. "/" acts as line terminating character. In case of using a wrong second character, it is necessary to start again with character "a" or "A".

Syntax

Exec Command	
A/	
Response(s)	
PIN → Last	Reference(s)
- + -	V.250

15.2 ATS3 Command Line Termination

[ATS3](#) determines the character recognized by the ELS31-V to terminate an incoming command line. It is also generated for result codes and information text, along with character value set via [ATS4](#).

Syntax

Read Command	
ATS3?	
Response(s)	
<n> OK	
Write Command	
ATS3= <n>	
Response(s)	
OK ERROR	
PIN → Last	Reference(s)
- + -	ITU-T V.250 [9]

Parameter Description

<n> ^{(num)(&V)(&W)}
Command line termination character. It is not recommended to change this value. 000...013 ^(&F) ...127

Note

- If changing this setting the new value has no effect for "[^SHUTDOWN](#)" URC.

15.3 ATS4 Response Formatting

[ATS4](#) determines the character generated by the ELS31-V for result code and information text, along with the command line termination character set via [ATS3](#).

Syntax

Read Command	
ATS4?	
Response(s)	
<n> OK	
Write Command	
ATS4= <n>	
Response(s)	
OK ERROR	
PIN → Last	Reference(s)
- + -	ITU-T V.250 [9]

Parameter Description

<n> ^{(num)(&V)(&W)}
Response formatting character. It is not recommended to change this value. 000...010 ^(&F) ...127

15.4 AT55 Command Line Editing

AT55 determines the character value used by the ELS31-V to delete the immediately preceding character from the AT command line (i.e. equates backspace key).

Syntax

Read Command	
AT55?	
Response(s)	
<n>	
OK	
Write Command	
AT55=<n>	
Response(s)	
OK	
ERROR	
PIN → Last	Reference(s)
- + -	ITU-T V.250 [9]

Parameter Description

<n> ^{(num)(&V)(&W)}
Command line editing character. It is not recommended to change this value. 000...008 ^(&F) ...127

15.5 AT^SBNR Binary Read

Syntax

Test Command

```
AT^SBNR=?
```

Response(s)

```
OK
```

Read Command

```
AT^SBNR?
```

Response(s)

```
OK
```

Write Command

If **<type>**= "ciphersuites": Read default values of TLS Cipher Suites for embedded TCP/IP stack:

```
AT^SBNR="ciphersuites", "default"
```

Response(s)

```
(default CYASSL ciphers string)
```

```
OK
```

```
ERROR
```

```
+CME ERROR: <err>
```

Write Command

If **<type>**= "ciphersuites": Read user defined TLS Cipher Suites for embedded TCP/IP stack, or default values if not defined:

```
AT^SBNR="ciphersuites", "current"
```

Response(s)

```
(ciphersuite user file contents)
```

```
OK
```

If no user values defined:

```
No Cipher Suites file found or loaded
```

```
Default Cipher Suites:
```

```
(default CYASSL ciphers string)
```

```
OK
```

```
ERROR
```

```
+CME ERROR: <err>
```

Write Command

If **<type>**= "is_cert": Read certificates for secure connection of client IP services

```
AT^SBNR="is_cert"
```

Response(s)

```
^SBNR: <index>, <size>, <issuer>, <serial-number>, <subject>, <signature-algorithm>,  
<thumbprint-algorithm>, <thumbprint>
```

```
[... ]
```

```
OK
```

```
ERROR
```

```
+CME ERROR: <err>
```

If certificate file is corrupted:

```
^SBNR: <index>, certificate is corrupted
```

PIN → Last

- + -

Parameter Description

<type>^(str)

“ciphersuites” Read TLS Cipher Suites for embedded TCP/IP stack
“is_cert” Read certificate details
See [4] for further details. See also AT^SISS, AT^SIND and AT^SBNW.

<index>^(num)

Certificate index
0...10 Index 0 is handled as public client certificate (only 1 allowed). It is intended for client authentication and for protecting access to the (server) certificate store in the UE's NVRAM.
Indexes from 1 to 10 are handled as server certificates.

<size>^(str)

Size of certificate file in bytes

<issuer>^(str)

Certificate issuer

<serial-number>^(str)

Serial number of certificate

<subject>^(str)

Subject of certificate

<signature-algorithm>^(str)

Signature algorithm of certificate

<thumbprint-algorithm>^(str)

Thumbprint algorithm of certificate

<thumbprint>^(str)

Thumbprint of certificate

15.6 AT^SBNW Binary Write

Syntax

Write Command

Cipher suites user file modification:

AT^SBNW="ciphersuites", file size

Response(s)

CONNECT

CIPHERSUITES: SEND FILE ...

Indicates that UE has entered binary data mode. Data can be transferred.

When Ciphersuites file data are transferred and updated, or error occurs the UE returns one of following answers:

CIPHERSUITES: LENGTH ERROR

CIPHERSUITES: FILE WRITE ERROR

CIPHERSUITES: SUITE NOT FOUND

CIPHERSUITES: UNDEFINED ERROR

CIPHERSUITES: INTERNAL ERROR

CIPHERSUITES: I/O ERROR

OK

Write Command

Cipher suites user file removal:

AT^SBNW="ciphersuites", 0

Response(s)

CIPHERSUITES: DELETE CIPHERSUITES FILE...

CIPHERSUITES: DONE

OK

+CME ERROR: <err>

Write Command

Certificate management for secure connection of client IP services

AT^SBNW="is_cert", <subType>

Response(s)

CONNECT

SECURE CMD READY: SEND COMMAND ...

(Indicates that UE has entered binary data mode. Secure command data can be transferred.)

When secure command data is processed the UE will send one of following answers:

SECURE CMD LENGTH ERROR

SECURE CMD PUBLIC CERTIFICATE IS CORRUPTED

SECURE CMD PRIVATE KEY WAS REMOVED

SECURE CMD SERVICE TIMEOUT ERROR

SECURE CMD TO MANY DATA ERROR

SECURE CMD ERROR

SECURE CMD END OK

PIN → Last

- + -

Parameter Description

<type>^(str)

“ciphersuites” Command for IOverAT TLS Cipher Suite file management.
“is_cert” Secure Command Mode (Manage Certificates)
See [4] for further details. See also AT^SISS, AT^SIND and AT^SBNR.

<subType>^(num)

1 Start Secure Command Block Transfer mode

15.7 AT^SFDL Firmware Download

[AT^SFDL](#) allows the application manufacturer to download ELS31-V firmware into the ME by starting the download process on a customer-designed update tool.

For this purpose the ELS31-V firmware update file must be available in *.USF format. This file is part of each product specific firmware package supplied by Gemalto M2M GmbH. The firmware file consists of records to be transferred one by one from the update tool to the ME.

This manual only describes the syntax of the [AT^SFDL](#) command. Details on technical requirements and steps to prepare the host application for this download solution can be found in "[Application Note 16: Updating ELS31-V Firmware](#)" [3]. An example for developing an appropriate update tool is included.

The command causes the ME to reset and enter the firmware download mode (this may take some milliseconds). After entering the download mode the ME sends the start pattern HEX 0x01 ("ANSWER_OK") to the update tool to indicate its ready state. Next, the update tool shall start to send the records of the firmware file. Each record received by the ME is acknowledged to the update tool. Once all records are successfully received, the ME shuts down automatically.

If a valid firmware is still installed, but the [AT^SFDL](#) command is issued without sending any firmware afterwards the ME will stay in ready state. In this case it must be switched off.

Syntax

```
Test Command
AT^SFDL=?
Response(s)
OK

Exec Command
AT^SFDL
Response(s)
OK
0x01

PIN → Last
- + +
```

16. Hardware related Commands

All AT commands described in this chapter are related to the hardware interface of the ELS31-V. Further information regarding this interface is available in the "ELS31-V Hardware Interface Description" [2].

16.1 AT+CCLK Real Time Clock

The [AT+CCLK](#) write command sets the Real Time Clock in the UE.

The [AT+CCLK](#) read command shows the time and, if enabled with [AT+CTZU](#), time zone information.

Syntax

Test Command	
AT+CCLK=?	
Response(s)	
OK	
Read Command	
AT+CCLK?	
Response(s)	
+CCLK: <time>	
OK	
Write Command	
AT+CCLK=<time>	
Response(s)	
OK	
ERROR	
+CME ERROR: <err>	
PIN → Last	Reference(s)
- + -	3GPP TS 27.007 [39]

Parameter Description

<time>^(str)

Format is "yy/mm/dd,hh:mm:ss+zz", where the characters indicate the two last digits of the year, followed by month, day, hour, minutes, seconds and time zone. For example 6th of July 2016, 22:10:00 GMT+2 hours equals to "16/07/06,22:10:00+08".

Factory default is "70/01/01,00:00:00+00".

Time zone information zz:

Automatic time zone information update is effective only if enabled with [AT+CTZU](#) and if the network supports time zone information. When a time zone update occurs additional time zone information will be appended to parameter <time>.

Time zone tz is given as a positive (east) or negative (west) offset from UTC in units of 15 minutes: Format is "yy/mm/dd,hh:mm:ss+zz" or "yy/mm/dd,hh:mm:ss-zz".

If not enabled or if the UE is not registered with a network the value will be only +00.

In addition, time zone updating can be reported by URCs enabled with [AT+CTZR](#) and [AT^SIND](#).

Note

- `<time>` will be reset to its factory default when the UE reboots via `AT+CFUN=1,1` or enters Power Down mode via `AT^SMSO`.

16.2 AT^SBV Battery/Supply Voltage

[AT^SBV](#) allows to monitor the supply (or battery) voltage of the module. The voltage is periodically measured. The displayed value is averaged.

The measurement is related to the reference points of BATT+ and GND. For details on the reference points please refer to the Hardware Interface Description [2]. If the measured average voltage drops below or rises above the given voltage thresholds the UE will report alert messages by sending the "^SBC" URCs listed in Section 1.7.1, [Common URCs](#).

Syntax

Test Command

```
AT^SBV=?
```

Response(s)

```
OK
```

```
ERROR
```

```
+CME ERROR: <err>
```

Exec Command

```
AT^SBV
```

Response(s)

```
^SBV: <Voltage>
```

```
OK
```

```
ERROR
```

```
+CME ERROR: <err>
```

PIN → Last

- + -

Parameter Description

<Voltage>^(num)

Supply (or battery) voltage in mV

16.3 AT^SCTM Critical Operating Temperature Monitoring

AT^SCTM allows to monitor the operating temperature range of the ELS31-V device. Refer to "ELS31-V Hardware Interface Description" [2] for specifications on critical temperature ranges. To avoid damage the module will shut down once the critical temperature is exceeded. The procedure is equivalent to the power-down initiated with **AT^SMSO**.

The **AT^SCTM** write command controls the presentation of URCs to report critical operating temperature limits. Use parameter **<UrcMode>** to enable (1) and disable (0) URC presentation.

Each time after the ELS31-V was switched on there is a guard period of 120 seconds. Until expiry of the guard timer, automatic thermal shutdown will be deferred and the presentation of all ^SCTM URC types is enabled even though **<UrcMode>** equals "0".

URCs indicating alert levels "1" or "-1" are intended to enable the user to take precautions, such as protect the ELS31-V from exposure to extreme conditions, or save or back up data etc. Except during the initial guard period after startup, the presentation of level "1", "-1" or "0" URCs depends on **<UrcMode>**.

Level "2" or "-2" URCs are followed by immediate shutdown except during the initial guard period. The presentation of these URCs is always enabled, i.e. they will be output even though **<UrcMode>** equals "0".

AT^SCTM read command returns:

- The URC presentation mode.
- Information about the current temperature range of the ELS31-V device.
- The board temperature (in degree Celsius) if parameter **<tempCtrl>**=1.

Syntax

Test Command

AT^SCTM=?

Response(s)

^SCTM: (list of supported **<UrcMode>**s)[, (list of supported **<tempCtrl>**s)]

OK

Read Command

AT^SCTM?

Response(s)

^SCTM: **<UrcMode>**, **<UrcCause>**[, **<temp>**]

OK

ERROR

+CME ERROR: **<err>**

Write Command

AT^SCTM=<UrcMode>[, **<tempCtrl>**]

Response(s)

OK

ERROR

+CME ERROR: **<err>**

PIN → Last

- + -

Unsolicited Result Codes

URC 1

URCs will be sent to the TE when the temperature reaches or exceeds the critical level, or when it is back to normal.

^SCTM_B: <UrcCause>

URC 2

URC indicated after "^SCTM_B" URC with <UrcCause> value 2 or -2 before the UE switches off.

^SHUTDOWN

Parameter Description

<UrcMode>^(num)

URC presentation mode

0 ^(P)	Disable URC presentation (except for <UrcCause> equal to -2 or +2).
1	Enable URC presentation.

<UrcCause>^(num)

-2	Below lowest temperature limit (causes immediate switch-off)
-1	Below low temperature alert limit
0	Normal operating temperature
1	Above upper temperature alert limit
2	Above uppermost temperature limit (causes immediate switch-off)

<tempCtrl>^(num)

0 ^(P)	Suppress output of <temp> in read command.
1	Output <temp> in read command.

<temp>^(num)

Board temperature in Celsius. Is comprised between the lowest temperature warning level and the uppermost temperature warning level.

Examples

EXAMPLE 1

URCs issued when the operating temperature is out of range:

^SCTM_B: 1	Caution: Module close to overtemperature limit.
^SCTM_B: 2	Alert: Module is above overtemperature limit and switches off.
^SCTM_B: -1	Caution: Module close to undertemperature limit.
^SCTM_B: -2	Alert: Module is below undertemperature limit and switches off.

EXAMPLE 2

URCs issued when the temperature is back to normal (URC is output once):

^SCTM_B: 0	Module back to normal temperature.
------------	------------------------------------

16.4 AT^SLED LED Feature

AT^SLED controls the LED function provided by the ELS31-V's STATUS pin, which acts as an output and can be used to control a connected LED.

The AT^SLED command is functional only if LED functionality is enabled with AT^SCFG="Gpio/mode/SYNC" set to "std". The electrical specifications of the status pin and advice on how to connect the LED circuit can be found in [2]. The LED indicates the operating states listed below:

Table 16.1: ELS31-V Status and Mode Indication via LED

ELS31-V Status	<mode>=1	<mode>=2
LTE data transfer	Permanently on	10 ms on / 1990 ms off
UE registered to a network. No call, no data transfer	Permanently on	1280 ms on / 3840 ms off
Limited Network Service (e.g. because no SIM/USIM, no PIN or during network search)	500ms on / 500 ms off	500ms on / 500 ms off

Syntax

```

Test Command
AT^SLED=?
Response(s)
^SLED: (list of supported <mode>s)
OK

Read Command
AT^SLED?
Response(s)
^SLED: <mode>
OK

Write Command
AT^SLED=<mode>
Response(s)
OK
ERROR
+CME ERROR: <err>

PIN → Last
- + -
    
```

Parameter Description

<mode> ^(num)	
LED operating mode	
0 ^(P)	LED feature is disabled.
1	LED lights steadily when the UE is registered to the network and either awake or in power saving state.
2	LED is flashing when the UE is in Limited Service or registered with a network and either awake or in power saving state.

Note

- The LED functionality is effective only when `AT+CFUN=1` or `4`. It is disabled when `AT+CFUN=0`.

Parameter Description

`<op>`^(num)

Operation

Open or close ADC channel for measurement.

0	Close ADC channel (value of parameter <code><it></code> is ignored).
1	Open ADC channel

`<it>`^(num)

Measurement interval

Parameter is used only if operation `<op>` is 1 (Open).

[0]	Single measurement mode
30,000...100	Output interval in ms in periodic measurement mode.

`<value>`^(num)

Measurement value

0...2000	Measured raw value of the actual voltage applied at the ADC_IN input pin in mV.
----------	---

`<count>`^(num)

1...11	Number of measured samples In single measurement mode: <code><count></code> is always 1. In periodic measurement mode: <code><count></code> is number of <code><value></code> s indicated by each URC " <code>^SRADC</code> ". The higher the sample rate set with <code><it></code> , the more measured values are reported within the URC " <code>^SRADC</code> ".
--------	--

Notes

- If power saving is enabled (see `AT^SPOW` and [2]), take into account that the periodic mode lets the ME consume current each time the measurement is performed. This reduces the effect of power saving and thus decreases the operation time.
- If an AT command is input on the same interface where the periodic measurement mode is on, up to 100 "`^SRADC`" URCs are queued up and sent after AT command completion. If more than 100 URCs occur before the AT command is completed their measurement values are lost.

Examples

EXAMPLE 1

Single measurement

<code>AT^SRADC=1</code>	Open ADC channel for single measurement.
<code>^SRADC: 1,78</code>	
<code>OK</code>	

EXAMPLE 2

Periodic measurement at low sample rate (5s):

<code>AT^SRADC=1,5000</code>	Start periodic measurement mode on the ADC channel. Samples are taken every 5s. Every 5s the URC " <code>^SRADC</code> " appears to report the measured voltages. The first parameter represents the number of measured samples, in this case only one.
<code>^SRADC: 1,76</code>	
<code>^SRADC: 1,78</code>	
<code>^SRADC: 1,76</code>	
<code>^SRADC: 1,76</code>	
<code>AT^SRADC=0</code>	Stop the periodic measurement
<code>OK</code>	

EXAMPLE 3

Periodic measurement at high sample rate (250ms):

AT^SRADC=1,250	Start periodic measurement on the ADC channel.
^SRADC: 5,76,76,77,76,76	Samples are taken every 250ms. Every second a
^SRADC: 5,76,76,75,76,76	URC " ^SRADC " appears to report the measured volt-
^SRADC: 5,77,77,76,76,76	age. The number of samples is 5.
^SRADC: 5,76,76,75,76,76	
AT^SRADC=0	
OK	Stop the periodic measurement

EXAMPLE 4

Handling of "**^SRADC**" URCs and AT command execution on the same interface:

AT^SRADC=1,250	Start periodic measurement mode on the ADC chan-
^SRADC: 5,76,76,77,76,76	nel. Samples are taken every 250ms.
^SRADC: 5,76,76,75,76,76	
^SRADC: 5,77,77,76,76,76	
^SRADC: 5,76,76,75,76,76	
AT^SRADC?	Input of AT command and <CR> takes some sec-
	onds.
^SRADC: 1,250	
OK	
^SRADC: 5,75,75,75,75,75	Some URCs were buffered during command input
^SRADC: 5,76,76,77,76,76	and sent after completion.
^SRADC: 5,76,76,75,76,76	
^SRADC: 5,77,77,76,76,76	
^SRADC: 5,76,76,75,76,76	
^SRADC: 5,77,77,76,76,76	
^SRADC: 5,76,76,77,76,77	
^SRADC: 5,76,76,75,76,76	

16.6 AT^SSPI Serial Protocol Interface

The `AT^SSPI` command enables the module to be connected to external I²C or SPI devices.

Keep in mind that the two SPI chip select lines are shared with GPIO lines: SPI_CS1 with GPO26, SPI_C2 with GPIO27. Therefore, a connected SPI device is only accessible if `AT^SCFG="Gpio/mode/SPI"` is set to "std" instead of "gpio". All other SPI lines are dedicated.

The I²C/SPI datastream is mapped through an internal I²C/SPI driver to and from an ASCII hex protocol which can be exchanged with an external application via V24.

The `AT^SSPI` write command configures and activates the I²C/SPI interface and changes from command mode into data mode. All values must be given in hexadecimal format (0 - 9, A - F) without "0x". For details on data mode please refer to Section 16.6.2, [Transmitting Data over AT Interface](#).

Syntax

Test Command

```
AT^SSPI=?
```

Response(s)

```
^SSPI:(list of supported <basicConfiguration>s), (list of supported <wordLength>s), (list of supported <extendedSpiConfiguration>s)
OK
```

Read Command

```
AT^SSPI?
```

Response(s)

```
^SSPI: <connectionState>, <basicConfiguration>, <wordLength>, <extendedSpiConfiguration>
OK
ERROR
+CME ERROR: <err>
```

Write Command

```
AT^SSPI=[<basicConfiguration>[, <wordLength>[, <extendedSpiConfiguration>]]]
```

Response(s)

```
CONNECT
(indicates that ME has entered data mode)
ERROR
+CME ERROR: <err>
```

PIN → Last

- + +

Parameter Description

`<connectionState>`^(num)

Parameter returned by the `AT^SSPI?` read command. Indicates whether or not the I²C or SPI channel is used. When the channel is open and the ME is in data mode, the read command can only be used if one of the remaining interfaces is available.

- | | |
|-----|---|
| [0] | Not connected (channel closed). All following parameters are the factory settings ^SSPI: 0,0000,0000,0000. |
| 1 | Connected (channel open, ME in data mode). All following parameters are the values currently used, for example ^SSPI: 1,0000,0000,0000. |

16.6.1 Selecting SPI Mode

The figure shows the four types of SPI mode selectable by setting the appropriate hexadecimal value within the parameter `<extendedSpiConfiguration>`.

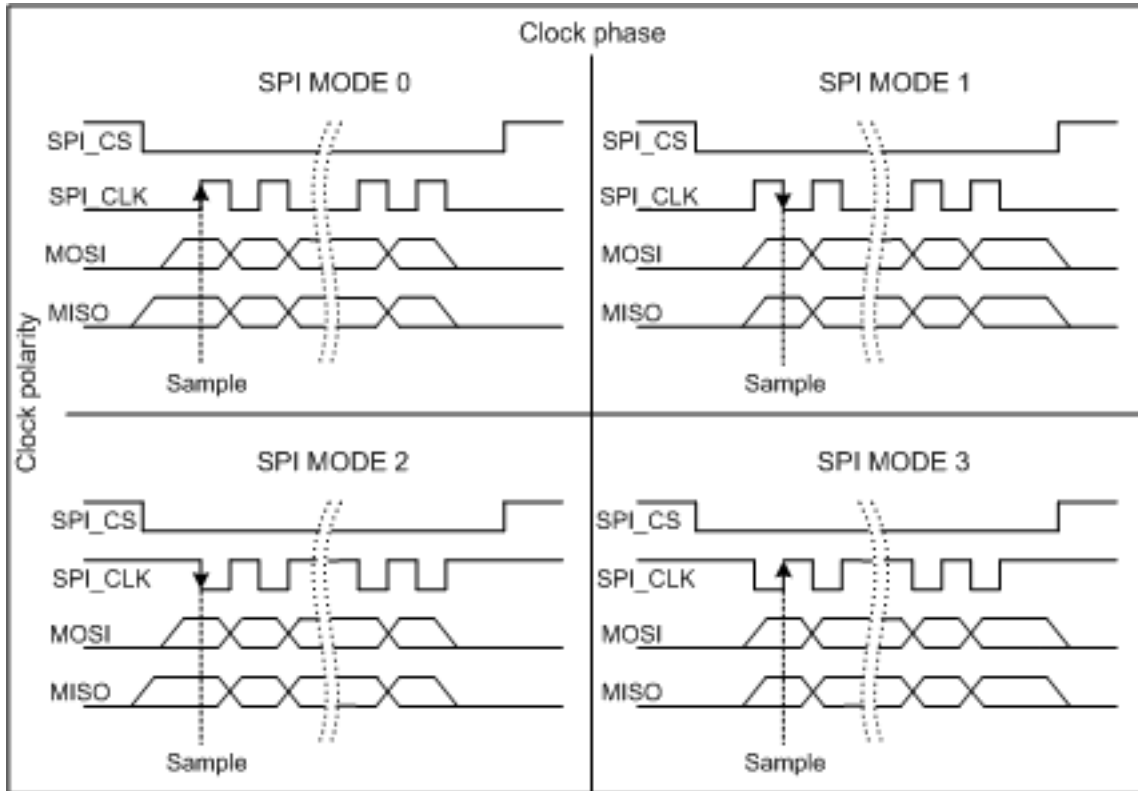

Figure 16.1: SPI modes selectable on SPI

16.6.2 Transmitting Data over AT Interface

This section provides information on the protocol used for data transmission to or from I²C /SPI devices and explains the data mode. It is assumed that you are familiar with the I²C specification.

Throughout this section the following document conventions are used to mark the direction of send and receive:

Transfer Message: AT → I²C or SPI device driver

Response Message: AT ← I²C or SPI device driver

Channel Open / Close:

To change from command mode to data mode use the AT^SSPI write command. To close down the channel and return to command mode send the ASCII code # (0x23).

ASCII Protocol for I²C or SPI communication over AT interface:

The protocol allows using a Terminal program for the communication between the module and the I²C slave device/SPI device. To visualize transferred characters and response data it is recommended to run the Terminal program in chat mode or to switch on local echo.

For transfer and response, special characters are defined, such as Start and Stop to mark a single message and Close to disconnect the data channel. All valid special characters are listed below:

Table 16.2: Special characters for ASCII coding

Direction AT - Driver	Function in protocol	Special character	Hex value	Description
→	Start Transfer Message	<	0x3C	Special character sent to the I ² C/SPI driver to start sending.
→	Stop Transfer Message	>	0x3E	Special character sent to the I ² C/SPI driver to stop sending.
→	Channel Close	#	0x23	For signalling. Channel Close can be sent any time inside or outside a transmit or receive message. Causes the transfer to be aborted and takes the ME back to AT command mode.
←	Start Response Message	{	0x7B	Special character sent to the I ² C/SPI driver to mark the beginning of a Response Message.
←	Stop Response Message	}	0x7D	Special character sent to the I ² C/SPI driver to mark the end of a Response Message.
←	Protocol error	!	0x21	For signalling. Reports to the AT interface that the Transfer Frame does not comply with the protocol definition (syntax error).
←	Transmission OK (in I ² C protocol referred to as ACK)	+	0x2B	Notifies the AT interface that data were successfully transmitted or, on the I ² C bus, the I ² C Slave Address was recognized.
<i>On I²C bus only:</i>				
←	Transmission error (in I ² C protocol referred to as NAK)	-	0x2D	Notifies the AT interface that data transmission failed or the I ² C Slave Address was not recognized. On the I ² C bus, the faulty data byte (16 bit byte counter) is identified as well.

Message syntax:

Each Message consists of a Start and Stop character, a Message-ID, further protocol data and user data. The notation of all elements is explained below:

Notation of Message-ID:

- All ASCII characters between 0x00...0x7F. It is recommended to use only the characters 0...9, A...Z, a...z.
- Length of the Message-ID: only one character

Notation of protocol data (except Message-ID) and user data:

- Hex (0...9, a...f, A...F)
- Without "0x" (0x01 → 01)
- Each hex value consists of 2 characters (1 → 01)
- Without delimiters such as comma, semicolon, space etc. (0xAE 0x01 0xA5 → AE01A5)
- In a Transfer Message, the number of all characters after the Message ID shall be even. If it is odd, a protocol error will be reported. On the I²C bus, this applies to the I²C Slave Address and all subsequent written user data. On the SPI this applies to the Read Offset Byte and the Read Length and, if available, all written user data. (Keep in mind that the number of all characters transmitted between Start "<" and Stop ">" of the Transfer Frame shall always be odd because the ID is one character only.)
- Length of I²C Slave Address and user data: ≤ 2048 bytes

The first element of each message is the Start character ("<" for Transfer, "{" for the Response). Accordingly, the last character of a message is the Stop character (">" for Transfer, "}" for the Response).

The second element of each message is the Message ID (1 character). The Message ID serves the user to distinguish between different messages. It is only relevant on protocol level (between AT interface and I²C device driver), i.e. it is not sent to the I²C slave device.

Each transfer to the device is followed by a Response Message sent from the driver to the AT interface. The response includes the Message ID and either OK ("+") or error characters ("- or "!"). A successful response to a Read Message contains the OK character and the read data. If an error occurs on the I²C bus, the response consists of an error character followed by a 16 bit code specifying the faulty byte.

After each Transfer Message, wait for the Response Message before sending the next Transfer Message.

All characters entered outside a valid message (i.e. not input between Start character "<" and Stop character ">") are ignored.

16.6.2.1 Structure of Messages on the I²C Bus

Table 16.3: Structure of Transfer and Response Messages on the I²C bus

Frame	Format
Write Transfer Message	< ID SlaveAddress Data > Maximum length: 2048 bytes for I ² C Slave Address and written data. LSB of I ² C Slave Address = "0".
Read Transfer Message	< ID SlaveAddress ReadLength > Read Length ≤ 2048 bytes. LSB I ² C of Slave Address = "1".
Response Message	
Write OK	{ID + }
Read of x bytes OK	{ID + Data }
NAK for x th byte if Read or Write	{ID - xxxx }
Protocol error in x th byte	{ID ! xxxx }

On the I²C bus, read and write data are handled in two separate frames transmitted one after the other. This is because the I²C bus has only two bus lines, I2CDAT for the serial data and I2CCLK for the serial clock. Write data are packed into a Transfer Frame. Read data are packed into a Response Frame. The Transfer Frame con-

tains a Receive or Transmit Request (R/W Request) for the I²C master.

In a Transfer Message (Read or Write), the third element is the 7-bit I²C Slave Address (2 characters) that identifies each single device connected to the bus. The 8th bit of this byte is the LSB that determines the direction of the message. If the LSB is "0" the master will write information to the selected slave. If the LSB is "1" the master will read information sent from the slave.

In a Read Transfer Message on the I²C bus, the size of the expected data must be specified explicitly. This is an element of 4 characters stating the number of bytes to be read. It must be placed after the I²C Slave Address.

16.6.2.2 Structure of Messages on the SPI

Table 16.4: Structure of Transfer and Response Messages for SPI

Message	Format
Transfer Message	Read data: <ID ReadOffset ReadLength> Write data: <ID Data> Read and write data: <ID ReadOffset ReadLength Data> Read Offset = 8 bits Read Length = 16 bits Max. length of data: 2048 bytes
Response Message	
Write OK	{ID +}
Reading x bytes was OK	{ID + Data }
Protocol error in x th byte	{ID ! xxxx }

The SPI has two serial data lines, MOSI for sending data from the master to the slave, and MISO for receiving data sent from the slave to the master. Both data lines are controlled by one serial clock line SPI_CLK. ELS31-V acts as master providing the clock. Write and read data are handled in the same Transfer Messages and Response Messages. In a Transfer Message, the next two elements after the ID are the Read Offset and the Read Length, both required to enable reading data from the slave. The Read Offset specifies where to start reading, i.e. which byte is the first to start reading from. If the Read Offset is zero then reading starts from the first byte. The Read Length specifies the number of expected bytes. If the Read Offset is zero and the Read Length does not equal zero, the master reads the specified number of bytes, starting from the first byte. If the Read Length is zero, the Read Offset is ignored, meaning that the master will not read data from the slave. To transmit data from the master to the slave all data can be entered after the Read Length.

In a Response Message the ID is followed by a special character to indicate the result of reading. If successful, "+" is given, followed by the read data. If reading fails only "!" is received.

16.6.3 Error Handling on the I²C Bus

Protocol error:

If a protocol error is detected the ASCII value "!" is sent to the AT interface. Also, a Stop Condition is sent to the I²C device.

A protocol error occurs if

- any data / address characters do not equal 0...9, a...f and A...F
- the length of a read word is smaller or greater than 16 bits
- the number of ASCII data is odd (e.g. "af1" instead of "af01")
- the Read or Write request is greater than 2 KB (0x0800).

Acknowledge:

Once a transmission has completed successfully (Write or Read), the special character "+" (ACK) is included in the Response sent to the AT interface.

During a Write Transfer, the I²C driver acknowledges each transferred byte, but the Response contains only one

ACK which is transmitted only if all bytes are successfully transferred. During a Read Transfer, an ACK is sent when the I²C slave device notifies that it has recognized the I²C Slave Address.

Not Acknowledge:

During a Transmit Transfer, a NAK is given when the I²C Slave Device notifies a failure to receive either the I²C Slave Address or a data byte. In this case, a Stop Condition is sent to the I²C device.

During a Receive Transfer, a NAK is transmitted only when the I²C does not receive any response for the I²C Slave Address. The I²C device never acknowledges the validity of the received data (by sending an ACK the master acknowledges each received byte to the slave).

16.6.4 Example: Using I²C Bus

As stated above, it is recommended to run the Terminal program in chat mode or to use the local echo. First, activate the I²C interface:

```
AT^SSPI=0000,0000,0000
CONNECT
```

The first group of characters forms the [<basicConfiguration>](#), where the first "0" sets I²C, the second "0" is the internal port, the digit "0" sets 100 kbps bit rate on the I²C bus, and the next "0" selects ASCII coding.

Note: If omitted all above parameters are assumed by default. Therefore, instead of AT^SSPI=0000,0000,0000 it is sufficient to enter only AT^SSPI=

The module is in data mode now. This allows you to send a Write Transfer Message:

```
<aAE000102030405060708090A0B0C0D0E0F>
```

```
{a+}
```

```
<bAF0010>
```

```
{b+000102030405060708090A0B0C0D0E0F}
```

Write Transfer Frame, where a = ID, AE = Slave Address and write request.

Write Response Message, where a = ID.

Read Transfer Message, where b = ID, AF = Slave Address and read request, 0010 = number of expected bytes.

Read Response Message, where b = ID.

To quit data mode and return to command mode enter the Close character "#":

```
#
OK
```

The response OK confirms that the ME is back to command mode and ready to accept any AT commands.

If the ME is in command mode, the response to the read command contains the factory settings.

```
AT^SSPI?
^SSPI: 0,0000,0000,0000
```

```
OK
```

The read command returns the connection state "not connected" (Channel closed) and the factory settings for I²C.

If the ME is in data mode, the response to the read command contains the current settings.

```
AT^SSPI?
^SSPI: 1,0000,0000,0000
```

```
OK
```

The read command returns the connection state "connected" (Channel open) and the current settings for I²C.

16.6.5 Example: Transfer and Response Messages on SPI

The following examples shall illustrate the message structure and write/read procedures explained in Section [16.6.2.2, Structure of Messages on the SPI](#). Blanks are inserted only to better visualize frame elements. In practice no blanks are allowed.

<pre><0 00 0000 11 22 33> { 0 + }</pre>	<p>Transfer Message: The master writes 3 bytes. Response Message: Transmission successful.</p>
<pre><1 00 0010> { 1 + 11 22 33 44 ... FF 00 }</pre>	<p>Transfer Message: The master requests to read 16 bytes from the slave. Read Offset is zero, therefore, reading starts from the first byte. Response Message: Reading data successful.</p>
<pre><2 03 0008> { 2 + 44 55 66 77 88 99 AA BB }</pre>	<p>Transfer Message: The master requests to read 8 bytes from the slave. Read Offset is 3, therefore, reading starts from the fourth byte. Response Message: Reading data successful.</p>
<pre><3 03 0004 11 22 33 44 55 66> { 3 + AA BB CC DD }</pre>	<p>Transfer Message: The master writes 6 bytes and requests to read 4 bytes from the slave. Read Offset is 3, therefore, reading starts from the fourth byte. Response Message: Reading and writing data successful.</p>

17. General Purpose I/O (GPIO) Pin related Commands

This chapter describes the AT commands used to access and configure the GPIO pins of ELS31-V.

Please also refer to [2] for electrical specifications of the GPIO pins.

17.1 AT^SCPIN Pin Configuration

The `AT^SCPIN` write command serves to add (or remove) and configure GPIO lines. Keep in mind that some GPIO lines share functions with other interfaces. For details see `AT^SCFG` "GPIO/mode/xxx" settings, Section 17.1.1, [GPIO Configuration Table](#) and following AT commands: `AT^SLED`, `AT^SCCNT`, `AT^SSPI`, `AT^SCFG` "MEShutdown/Fso".

Syntax

```

Test Command
AT^SCPIN=?
Response(s)
^SCPIN:(list of supported <mode>s), (list of supported <pin_id>s), (list of supported <direction>s), (list of supported <startValue>s)
OK

Write Command
AT^SCPIN=<mode>, <pin_id>, <direction>[, <startValue>]
Response(s)
OK
ERROR
+CME ERROR: <err>
    
```

Parameter Description

<code><mode></code> ^(num)	
0	Close GPIO line
1	Open GPIO line

<code><pin_id></code> ^(num)	
Pin identifier	
0	GPIO1
1	GPIO2
2	GPIO3
3	GPIO4
4	GPO5
5	GPIO6
6	GPIO7
7	GPIO8

17.1 AT^SCPIN

15	GPIO16
16	GPIO17
17	GPIO18
18	GPIO19
19	GPIO20
20	GPIO21
21	GPIO22
22	GPIO23
23	GPIO24
24	GPIO25
25	GPO26
26	GPIO27

`<direction>(num)`

Parameter `<direction>` is mandatory when opening a GPIO line, but can be omitted when closing a GPIO line.

0	Input
1	Output

`<startValue>(num)`

Can be set only for outputs.

[0]	Low
1	High

Notes

- For closing a GPIO line with the write command (`<mode>=0`), the parameter `<direction>` is not needed.
- Before changing the configuration of a GPIO line be sure to close the GPIO line.

17.1.1 GPIO Configuration Table

Some GPIO lines are shared with other interfaces, such as ASC1, Fast Shutdown line, Pulse Counter, SPI (Serial Peripheral Interface) and a status LED. The following table shows the configuration variants. All variants are mutually exclusive, i.e. a line configured for GPIO usage is locked for alternative use and vice versa.

GPIO Pin	GPIO Handler	Status LED	Pulse Counter	ASC0	ASC1	Fast Shut-down	SPI
GPIO1	yes	no	no	yes	no	no	no
GPIO2	yes	no	no	yes	no	no	no
GPIO3	yes	no	no	yes	no	no	no
GPIO4	yes	no	no	no	no	yes	no
GPO5	yes	yes	no	no	no	no	no
GPIO6	yes	no	no	no	no	no	no
GPIO7	yes	no	no	no	no	no	no
GPIO8	yes	no	yes	no	no	no	no
GPIO16	yes	no	no	no	yes	no	no

GPIO Pin	GPIO Handler	Status LED	Pulse Counter	ASC0	ASC1	Fast Shut-down	SPI
GPIO17	yes	no	no	no	yes	no	no
GPIO18	yes	no	no	no	yes	no	no
GPIO19	yes	no	no	no	yes	no	no
GPIO20	yes	no	no	no	no	no	no
GPIO21	yes	no	no	no	no	no	no
GPIO22	yes	no	no	no	no	no	no
GPIO23	yes	no	no	no	no	no	no
GPIO24	yes	no	no	yes	no	no	no
GPIO25	yes	no	no	no	no	no	no
GPO26	yes	no	no	no	no	no	yes
GPIO27	yes	no	no	no	no	no	yes

17.2 AT^SGIO Get IO State of a Specified Pin

Syntax

Test Command

```
AT^SGIO=?
```

Response(s)

```
^SGIO:(list of supported <io_id>s)  
OK
```

Write Command

```
AT^SGIO=<io_id>
```

Response(s)

```
^SGIO: <value>  
OK  
ERROR  
+CME ERROR: <err>
```

PIN → Last

- + -

Parameter Description

<io_id>^(num)

This is an already configured <pin_id> (see AT^SCPIN).

<value>^(num)

State read on this <io_id>.

0	Low for <pin_id>
1	High for <pin_id>

17.3 AT^SSIO Set IO State of a Specified Pin

Syntax

Test Command

```
AT^SSIO=?
```

Response(s)

```
^SSIO:(list of supported <io_id>s), (list of supported <value>s)  
OK
```

Write Command

```
AT^SSIO=<io_id>, <value>
```

Response(s)

```
OK  
ERROR  
+CME ERROR: <err>
```

PIN → Last

- + -

Parameter Description

<io_id>^(num)

This is an already configured <pin_id> (see AT^SCPIN).

<value>^(num)

State to be set for this <io_id>.

0	Low for <pin_id>
1	High for <pin_id>

17.4 AT^SSCNT Start and Stop Pulse Counter

The `AT^SSCNT` write command serves to read, start, restart and stop the pulse counter.

Syntax

```

Test Command
AT^SSCNT=?
Response(s)
^SSCNT: (list of supported <action>s)
OK

Read Command
AT^SSCNT?
Response(s)
^SSCNT: <action>
OK
If an error occurs:
ERROR
+CME ERROR: <err>

Write Command
AT^SSCNT=<action>
Response(s)
If <action>=0 or 1:
OK
If <action>=2 or 3:
OK
"^SSCNT" URC with parameter <pulse>
If an error occurs:
ERROR
+CME ERROR: <err>

```

PIN → Last

- + -

Unsolicited Result Code

`^SSCNT: <pulse>`

The URC applies only to the Start-Stop mode set with `AT^SSCNT`, parameter `<mode>=0`. It is delivered once the pulse counter result was requested with `<action>=2`, or the pulse counter was stopped with `<action>=3`. The URC indicates the number of pulses counted in batches of 8 pulses..

Parameter Description

`<action>`^(num)

This parameter can only be used after configuring the pulse counter with `AT^SSCNT` by using `<action>= 1` to open pulse counter, otherwise the `AT^SSCNT` read and write command will return error. The `<action>` types 0, 1 and 2 apply only to the Start-Stop counter mode set with `AT^SSCNT`, parameter `<mode>=0`.

- | | |
|---|--|
| 0 | Reset and start pulse counter from 0. |
| 1 | Restart pulse counter and continue counting from the <code><pulse></code> value of the last run. |
| 2 | Read out current <code><pulse></code> value. |

- 3 The effect of value 3 depends on the selected counter mode:
 If `AT^SSCNT`, parameter `<mode>= 0` (Start-Stop counter mode), then `<action>` type 3 stops the pulse counter and displays, as "`^SSCNT`" URC, the number of pulses counted until this time.
 If `AT^SSCNT`, parameter `<mode>= 1` (Limit counter mode), then `<action>` type 3 immediately stops the pulse counter without indicating the "`^SSCNT`" URC. This action has the same effect as the command `AT^SSCNT=0,0`.

`<pulse>`^(num)

Measurement result of the pulse counter in Start-Stop mode, indicated within the "`^SSCNT`" URC, if `AT^SSCNT`, parameter `<action>=2` or 3. The value range of `<pulse>` is 32 bits ($2^{31}-1$).

0...2147483647

Number of pulses counted.

The Pulse Counter works in batches of 8 pulses. In Start-Stop counter mode it reports only pulses per batches of 8 pulses.

Note

- Measurement accuracy: In Start-Stop mode, take care that pulse transmission begins after the start command (`AT^SSCNT=0` or 1) has returned OK and ends before the stop command (`AT^SSCNT=3`) is issued. Nevertheless, up to 4 pulses (depending on pulse frequency) may be lost when `<action>=2` (read) or 3 (stop) is sent within less than 15ms after the last pulse occurred.

17.4.1 Using the Pulse Counter in Start-Stop Counter Mode

<code>at^sscncnt=1,0</code>	Open pulse counter and enable Start-Stop counter mode.
OK	
<code>at^sscncnt=0</code>	Reset and start pulse counter from 0.
OK	
<code>at^sscncnt=2</code>	Request value.
OK	
<code>^SSCNT: 3248</code>	" <code>^SSCNT</code> " URC indicates number of pulses counted.
<code>at^sscncnt=2</code>	Request value.
OK	
<code>^SSCNT: 10024</code>	" <code>^SSCNT</code> " URC indicates number of pulses counted.
<code>at^sscncnt=2</code>	Request value.
OK	
<code>^SSCNT: 15136</code>	" <code>^SSCNT</code> " URC indicates number of pulses counted.
<code>at^sscncnt=3</code>	Request value and stop pulse counter.
OK	
<code>^SSCNT: 21024</code>	" <code>^SSCNT</code> " URC indicates number of pulses counted until this time.
<code>at^sscncnt=2</code>	Request value.
OK	
<code>^SSCNT: 21024</code>	" <code>^SSCNT</code> " URC still indicates the count of the last run.
<code>at^sscncnt=1</code>	Restart pulse counter at the value of the last run.
OK	
<code>at^sscncnt=2</code>	Request value.
OK	
<code>^SSCNT: 22120</code>	" <code>^SSCNT</code> " URC indicates number of pulses incremented from the last run.

17.5 AT^SCCNT Configure Pulse Counter

The `AT^SCCNT` write command serves to configure the GPIO8 line as pulse counter. The pulse counter is designed to measure signals from 0 to 1000 pulses per second. The measurement starts within <50ms after the OK result code has been sent.

Before execution of the `AT^SCCNT` write command take care that Pulse Counter functionality is enabled with `AT^SCFG="Gpio/mode/PULSE"` set to "std". Remember that if the GPIO8 line is configured as GPIO (see `AT^SCPIN`) any attempt to activate the pulse counter will be rejected. Vice versa, if the pulse counter is opened the GPIO8 line cannot be configured as GPIO.

See also [2] for further detail on the pulse counter.

Syntax

```

Test Command
AT^SCCNT=?
Response(s)
^SCCNT: (list of supported <action>s), (list of supported <mode>s), (list of supported <limit>s)
OK

Read Command
AT^SCCNT?
Response(s)
^SCCNT: <action>, <mode>[, <limit>]
OK
ERROR
+CME ERROR: <err>

Write Command
AT^SCCNT=<action>, <mode>[, <limit>]
Response(s)
OK
ERROR
+CME ERROR: <err>
    
```

PIN → Last
 - + -

Unsolicited Result Code

`^SCCNT: <time>`

The URC applies only to the Limit counter mode set with parameter `<mode>=1`. It is delivered once the pulse counter has completed counting the number of pulses requested with parameter `<limit>`.

Parameter Description

<code><action></code> ^(num)	
0	Close pulse counter
1	Open pulse counter

<mode> ^(num)	
0	Activates the Start-Stop counter mode. After setting this mode, use AT^SSCNT and the <action> parameter to start or stop the pulse counter or to read out the measured pulses.
1	Activates the Limit counter mode and immediately starts the pulse counter. Parameter <limit> is mandatory for this mode.

<limit> ^(num)	
1...65534	Number of pulses to be counted. Parameter <limit> applies only to the Limit counter mode and is mandatory for this mode. Once the given number of pulses is reached, the UE sends one single URC " ^SCCNT " which indicates the parameter <time>. The Pulse Counter works in batches of 8 pulses. In Limit counter mode it reports the right duration (see <time>), but if the <limit> parameter is not a multiple of 8, the report will be available after a batch of 8 pulses has completed.

<time> ^(num)	
1...2147483645	Time (in milliseconds) taken to count the number of pulses specified with <limit>. Measurement accuracy: The parameter <time> implies an inaccuracy <5ms which needs to be taken into account in addition to the measurement start-up time mentioned above.

17.5.1 Using the Pulse Counter in Limit Counter Mode

This example assumes that a 1 kHz frequency is applied at the GPIO8 line. Limit counter mode is enabled to request the time the pulse counter needs to count a specified number of pulses.

at^sccnt=1,1,1000	Open pulse counter, enable Limit counter mode, request the time needed to count 1000 pulses.
OK	
^SCCNT: 1047	" ^SCCNT " URC indicates the time taken to count 1000 pulses.
at^sccnt=1,1,2000	Open pulse counter, enable Limit counter mode, request the time needed to count 2000 pulses.
OK	
^SCCNT: 2040	" ^SCCNT " URC indicates the time taken to count 2000 pulses.
at^sccnt=1,1,10000	Open pulse counter, enable Limit counter mode, request the time needed to count 10000 pulses.
OK	
^SCCNT: 10043	" ^SCCNT " URC indicates the time taken to count 10000 pulses.
at^sccnt=1,1,20000	Open pulse counter, enable Limit counter mode, request the time needed to count 20000 pulses.
OK	
^SCCNT: 20040	" ^SCCNT " URC indicates the time taken to count 20000 pulses.

This example shows how to stop the Limit counter mode and close the pulse counter without waiting for the "[^SCCNT](#)" URC.

at^sccnt=0,0	Stop and close the pulse counter immediately, without " ^SCCNT " URC being indicated.
OK	

17.6 AT^SPIO GPIO Driver Open/Close

AT^SPIO AT^SPIO is implemented for compatibility reasons only, and has no effect.

Syntax

Test Command

```
AT^SPIO=?
```

Response(s)

```
^SPIO: (list of supported <mode>s)
```

```
OK
```

Write Command

```
AT^SPIO=<mode>
```

Response(s)

```
OK
```

```
ERROR
```

```
+CME ERROR: <err>
```

PIN → Last

- + -

Parameter Description

<mode>^(num)

0	Close General purpose I/O driver
1	Open General purpose I/O driver

18. Appendix

18.1 Available AT Commands and Dependency on SIM PIN

- ∅ ... Command not available
- ... Command does not require PIN1
- + ... Command requires PIN1
- ± ... Command sometimes requires PIN1

Table 18.1: Available AT Commands and Dependency on SIM PIN

AT Command	Exec	Test	Read	Write
Configuration Commands				
AT&F	-	∅	∅	∅
AT&V	-	∅	∅	∅
AT&W	-	∅	∅	∅
ATQ	-	∅	∅	∅
ATV	-	∅	∅	∅
ATZ	-	∅	∅	∅
AT+CFUN	∅	-	-	-
AT^SMSO	-	-	∅	∅
AT+CMEE	∅	-	-	-
AT+CSCS	∅	-	-	-
AT^SCFG	∅	-	-	-
AT^SPOW	∅	-	-	-
Status Control Commands				
AT+CEER	-	-	∅	-
AT^SIND	∅	-	-	-
AT+CPAS	-	-	∅	∅
AT+WS46	∅	-	-	-
Serial Interface Control Commands				
AT\Q	-	∅	∅	∅
AT&C	-	∅	∅	∅
AT&D	-	∅	∅	∅
AT&S	-	∅	∅	∅
ATE	-	∅	∅	∅
AT+ICF	∅	-	-	-
AT+IPR	∅	-	-	-
Identification Commands				
ATI	-	∅	∅	∅
AT+CGMI	-	-	∅	∅

18.1 Available AT Commands and Dependency on SIM PIN

AT Command	Exec	Test	Read	Write
AT+CGMM	-	-	∅	∅
AT+CGMR	-	-	∅	∅
AT+CGSN	-	-	∅	-
AT+GSN	-	-	∅	-
AT+CIMI	+	+	∅	∅
Security Commands				
AT+CPIN	∅	-	-	-
AT+CPINR	-	-	∅	-
AT+CLCK	∅	+	∅	+
AT+CPWD	∅	+	∅	+
Call related Commands				
ATH	-	∅	∅	∅
ATO	-	∅	∅	∅
+++	-	∅	∅	∅
Network Service Commands				
AT+COPN	-	-	∅	∅
AT+COPS	∅	±	±	±
AT+CESQ	+	+	∅	∅
AT+CPOL	∅	+	+	+
AT+CPLS	∅	+	+	+
AT+CTZR	∅	-	-	-
AT+CTZU	∅	-	-	-
AT^SMONI	-	-	∅	-
AT^SMONP	-	-	∅	-
AT^SNMON	∅	-	∅	-
Internet Service Commands				
AT^SICA	∅	+	+	+
AT^SICS	∅	-	-	-
AT^SIPS	∅	-	∅	-
AT^SISS	∅	-	-	-
AT^SISI	∅	-	-	-
AT^SISO	∅	-	-	+
AT^SISC	∅	-	∅	+
AT^SISR	∅	-	∅	+
AT^SISW	∅	-	∅	+
AT^SIST	∅	-	∅	-
AT^SISH	∅	-	∅	-
AT^SISX	∅	+	∅	+
AT^SISE	∅	-	∅	-

18.1 Available AT Commands and Dependency on SIM PIN

AT Command	Exec	Test	Read	Write
Packet Domain Related Commands				
AT+CGACT	∅	+	+	+
AT+CGATT	∅	+	+	+
AT+CGDCONT	∅	-	-	-
AT+CGDSCONT	∅	-	-	-
AT+CGCMOD	∅	+	∅	+
AT+CEREG	∅	+	+	+
AT+CGEREP	∅	+	+	+
AT+CGPADDR	+	+	∅	+
AT+CGPIAF	∅	+	+	+
AT+CGEQOS	∅	-	-	-
AT+CGEQOSRDP	∅	+	∅	+
AT+CGCONTRDP	+	+	∅	+
AT+CGSCONTRDP	∅	+	∅	+
AT+CGTFT	∅	-	-	-
AT+CGTFTRDP	+	+	∅	+
AT+CGAUTH	∅	-	-	-
AT+CGDATA	∅	+	∅	+
AT+CGSMS	∅	+	+	+
ATD*99#	+	∅	∅	∅
Short Message Service (SMS) Commands				
AT+CMGC	∅	+	∅	+
AT+CMGD	∅	+	∅	+
AT+CMGF	∅	-	-	-
AT+CMGL	+	+	∅	+
AT+CMGR	∅	+	∅	+
AT+CMGS	∅	+	∅	+
AT+CMGW	+	+	∅	+
AT+CMMS	∅	+	+	+
AT+CMSS	∅	+	∅	+
AT+CNMA	+	+	∅	+
AT+CNMI	∅	+	+	+
AT+CPMS	∅	+	+	+
AT+CSCA	∅	+	+	+
AT+CSDH	∅	-	-	-
AT+CSMP	∅	+	+	+
AT+CSMS	∅	+	+	+
AT^SMGL	+	+	∅	+
AT^SMGR	∅	+	∅	+
AT^SMGSIMS	∅	∅	∅	-

18.1 Available AT Commands and Dependency on SIM PIN

AT Command	Exec	Test	Read	Write
AT^SMGRIMS	∅	∅	∅	-
AT^SMGLIMS	-	∅	∅	∅
AT^SMGDIMS	∅	-	∅	-
AT^SIMSCFGSMS	∅	-	-	-
(U)SIM related Commands				
AT+CCID	-	-	-	∅
AT+CRSM	∅	-	∅	-
AT+CSIM	∅	-	∅	-
(U)SIM Application Toolkit (SAT) Commands				
AT^SSTA	∅	-	-	-
AT+STKPRO	∅	-	∅	∅
AT+STKTR	∅	±	∅	±
AT+STKENV	∅	±	∅	±
AT+STKCC	∅	∅	∅	∅
AT+STKCNF	∅	∅	∅	∅
Phonebook Commands				
AT+CNUM	+	+	∅	∅
Miscellaneous Commands				
A/	-	∅	∅	∅
ATS3	∅	∅	-	-
ATS4	∅	∅	-	-
ATS5	∅	∅	-	-
AT^SBNR	∅	-	-	-
AT^SBNW	∅	∅	∅	-
AT^SFDL	-	-	∅	∅
Hardware related Commands				
AT+CCLK	∅	-	-	-
AT^SBV	-	-	∅	∅
AT^SCTM	∅	-	-	-
AT^SLED	∅	-	-	-
AT^SRADC	∅	-	-	-
AT^SSPI	∅	-	-	-
General Purpose I/O (GPIO) Pin related Commands				
AT^SCPIN	∅	-	∅	-
AT^SGIO	∅	-	∅	-
AT^SSIO	∅	-	∅	-
AT^SSCNT	∅	-	-	-

AT Command	Exec	Test	Read	Write
AT^SCCNT	∅	-	-	-
AT^SPIO	∅	-	∅	-

18.2 Availability of AT Commands Depending on Operating Mode of ME

18.2 Availability of AT Commands Depending on Operating Mode of ME

- ... AT command not supported
 - + ... AT command supported
 - ± ... AT command partially supported
- See description of AT command for details.

Table 18.2: Availability of AT Commands Depending on Operating Mode of ME

AT Command	Normal Mode	→
Configuration Commands		
AT&F	+	+
AT&V	+	+
AT&W	+	+
ATQ	+	+
ATV	+	+
ATZ	+	+
AT+CFUN	+	+
AT^SMSO	+	+
AT+CMEE	+	+
AT+CSCS	+	+
AT^SCFG	+	±
AT^SPOW	+	+
Status Control Commands		
AT+CEER	+	+
AT^SIND	+	+
AT+CPAS	+	+
AT+WS46	+	+
Serial Interface Control Commands		
AT\Q	+	+
AT&C	+	+
AT&D	+	+
AT&S	+	+
ATE	+	+
AT+ICF	+	+
AT+IPR	+	+
Identification Commands		
ATI	+	+
AT+CGMI	+	+
AT+CGMM	+	+
AT+CGMR	+	+
AT+CGSN	+	+

18.2 Availability of AT Commands Depending on Operating Mode of ME

AT Command	Normal Mode	→
AT+GSN	+	+
AT+CIMI	+	+
Security Commands		
AT+CPIN	+	+
AT+CPINR	+	+
AT+CLCK	+	±
AT+CPWD	+	±
Call related Commands		
ATH	+	-
ATO	+	-
+++	+	+
Network Service Commands		
AT+COPN	+	+
AT+COPS	+	-
AT+CESQ	+	-
AT+CPOL	+	+
AT+CPLS	+	-
AT+CTZR	+	+
AT+CTZU	+	+
AT^SMONI	+	-
AT^SMONP	+	-
AT^SNMON	+	-
Internet Service Commands		
AT^SICA	+	-
AT^SICS	+	+
AT^SIPS	+	+
AT^SISS	+	+
AT^SISI	+	+
AT^SISO	+	-
AT^SISC	+	-
AT^SISR	+	-
AT^SISW	+	-
AT^SIST	+	-
AT^SISH	+	-
AT^SISX	+	-
AT^SISE	+	-
Packet Domain Related Commands		
AT+CGACT	+	+

18.2 Availability of AT Commands Depending on Operating Mode of ME

AT Command	Normal Mode	→
AT+CGATT	+	-
AT+CGDCONT	+	+
AT+CGDSCONT	+	+
AT+CGCMOD	+	-
AT+CEREG	+	+
AT+CGEREP	+	+
AT+CGPADDR	+	+
AT+CGPIAF	+	+
AT+CGEQOS	+	+
AT+CGEQOSRDP	+	-
AT+CGCONTRDP	+	-
AT+CGSCONTRDP	+	-
AT+CGTFT	+	+
AT+CGTFTRDP	+	-
AT+CGAUTH	+	+
AT+CGDATA	+	-
AT+CGSMS	+	+
ATD*99#	+	-
Short Message Service (SMS) Commands		
AT+CMGC	+	-
AT+CMGD	+	+
AT+CMGF	+	+
AT+CMGL	+	+
AT+CMGR	+	+
AT+CMGS	+	-
AT+CMGW	+	+
AT+CMMS	+	+
AT+CMSS	+	-
AT+CNMA	+	-
AT+CNMI	+	+
AT+CPMS	+	+
AT+CSCA	+	+
AT+CSDH	+	+
AT+CSMP	+	+
AT+CSMS	+	+
AT^SMGL	+	+
AT^SMGR	+	+
AT^SMGSIMS	+	-
AT^SMGRIMS	+	-
AT^SMGLIMS	+	-
AT^SMGDIMS	+	+

18.2 Availability of AT Commands Depending on Operating Mode of ME

AT Command	Normal Mode	→
AT^SIMSCFGSMS	+	-
(U)SIM related Commands		
AT+CCID	+	+
AT+CRSM	+	+
AT+CSIM	+	+
(U)SIM Application Toolkit (SAT) Commands		
AT^SSTA	+	+
AT+STKPRO	+	+
AT+STKTR	+	+
AT+STKENV	+	+
AT+STKCC	+	+
AT+STKCNF	+	+
Phonebook Commands		
AT+CNUM	+	+
Miscellaneous Commands		
A/	+	+
ATS3	+	+
ATS4	+	+
ATS5	+	+
AT^SBNR	+	+
AT^SBNW	+	+
AT^SFDL	+	+
Hardware related Commands		
AT+CCLK	+	+
AT^SBV	+	+
AT^SCTM	+	+
AT^SLED	+	+
AT^SRADC	+	+
AT^SSPI	+	+
General Purpose I/O (GPIO) Pin related Commands		
AT^SCPIN	+	+
AT^SGIO	+	+
AT^SSIO	+	+
AT^SSCNT	+	+
AT^SCCNT	+	+
AT^SPIO	+	+

18.3 AT Command Settings storable with AT&W

Table 18.3: Settings Stored to User Profile on ASC0

AT Command	Stored Parameters
Configuration Commands	
ATQ	<n>
ATV	<value>
AT+CMEE	<errMode>
Serial Interface Control Commands	
AT\Q	<n>
AT&C	<value>
AT&D	<value>
AT&S	<value>
ATE	<value>
AT+ICF	<format>, <parity>
Network Service Commands	
AT+COPS	<format>
Packet Domain Related Commands	
AT+CEREG	<n>
Short Message Service (SMS) Commands	
AT+CMGF	<mode>
AT+CNMI	<mode>, <mt>, <bm>, <ds>
AT+CSDH	<show>
AT+CSMS	<service>
Miscellaneous Commands	
ATS3	<n>
ATS4	<n>
ATS5	<n>

18.4 Factory Default Settings Restorable with AT&F

Table 18.4: Factory Default Settings Restorable with AT&F

AT Command	Factory Defaults
Configuration Commands	
ATQ	<n>=0
ATV	<value>=1
AT+CMEE	<errMode>=0
AT+CSCS	<chset>="GSM"
Serial Interface Control Commands	
AT\Q	<n>=3
AT&C	<value>=1
AT&D	<value>=2
AT&S	<value>=0
ATE	<value>=1
AT+ICF	<format>=3
Network Service Commands	
AT+COPS	<format>=0
Packet Domain Related Commands	
AT+CREG	<n>=0
Short Message Service (SMS) Commands	
AT+CMGF	<mode>=0
AT+CNMI	<mode>=1
AT+CSDH	<show>=0
AT+CSMS	<service>=0
Miscellaneous Commands	
ATS3	<n>=013
ATS4	<n>=010
ATS5	<n>=008

18.5 Summary of Unsolicited Result Codes (URC)

Table 18.5: Summary of Unsolicited Result Codes (URC)

AT Command	URC
Unsolicited Result Code Presentation	
	<code>^SYSSTART</code>
	<code>^SBC: Undervoltage Warning</code>
	<code>^SBC: Undervoltage Shutdown</code>
	<code>^SBC: Overvoltage Warning</code>
	<code>^SBC: Overvoltage Shutdown</code>
Configuration Commands	
<code>AT^SMSO</code>	<code>^SHUTDOWN</code>
Status Control Commands	
<code>AT^SIND</code>	<code>+CIEV: <indDescr>, <indValue></code>
<code>AT^SIND</code>	<code>+CIEV: <indDescr></code>
<code>AT^SIND</code>	<code>+CIEV: <indDescr>, <nitzUT>, <nitzTZ>, <nitzDST></code>
<code>AT^SIND</code>	<code>+CIEV: <indDescr>, <srvProfileId>, <issuer>, <serialNumber>, <subject>, <signatureAlgorithm>, <thumbprintAlgorithm>, <thumbprint></code>
Network Service Commands	
<code>AT+CTZR</code>	<code>+CTZV: <timezone></code>
<code>AT+CTZR</code>	<code>+CTZE: <timezone>, <dst>[, <time>]</code>
Internet Service Commands	
<code>AT^SISR</code>	<code>^SISR: <srvProfileId>, <urcCauseId></code>
<code>AT^SISW</code>	<code>^SISW: <srvProfileId>, <urcCauseId></code>
Internet Service URC " <code>^SIS</code> "	<code>^SIS: <srvProfileId>, <urcCause>[, [<urcInfoId>][, <urcInfoText>]]</code>
Packet Domain Related Commands	
<code>AT+CEREG</code>	<code>+CEREG: <stat></code>
<code>AT+CEREG</code>	<code>+CEREG: <stat>[, <tac>][, <ci>][, <AcT>]</code>
<code>AT+CGEREP</code>	<code>+CGEV: NW DEACT <pcid>, <cid>, <event-type></code>
<code>AT+CGEREP</code>	<code>+CGEV: ME DEACT <pcid>, <cid>, <event-type></code>
<code>AT+CGEREP</code>	<code>+CGEV: NW DETACH</code>
<code>AT+CGEREP</code>	<code>+CGEV: ME DETACH</code>
<code>AT+CGEREP</code>	<code>+CGEV: PDN DEACT <cid></code>
<code>AT+CGEREP</code>	<code>+CGEV: ME ACT <pcid>, <cid>, <event-type></code>
<code>AT+CGEREP</code>	<code>+CGEV: NW MODIFY <cid>, <change-reason>, <event-type></code>
<code>AT+CGEREP</code>	<code>+CGEV: NW PDN ACT <cid></code>
<code>AT+CGEREP</code>	<code>+CGEV: NW PDN DEACT <cid></code>
<code>AT+CGEREP</code>	<code>+CGEV: ME PDN DEACT <cid></code>

AT Command	URC
AT+CGEREP	+CGEV: NW ACT <pcid>, <cid>, <event-type>
AT+CGEREP	+CGEV: ME MODIFY <cid>, <change-reason>, <event-type>
AT+CGEREP	+CGEV: ME PDN ACT <cid>[, <reason>]
Short Message Service (SMS) Commands	
AT+CNMI	+CMTI: <mem3>, <index>
AT+CNMI	+CMT: [<alpha>], <length><CR><LF><pdu>
AT+CNMI	+CMT: <oa>, [<alpha>], <scts>[, <toa>, <fo>, <pid>, <dcs>, <sca>, <tosca>, <length>]<CR><LF><data>
AT+CNMI	+CDS: <length><CR><LF><pdu>
AT+CNMI	+CDS: <fo>, <mr>[, <ra>][, <tora>], <scts>, <dt>, <st>
AT+CNMI	+CDSI: <mem3>, <index>
AT^SMGSIMS	^SMGSIMS: SENT ERROR, <index>, 500
AT^SMGSIMS	^SMGSIMS: SENT OK, <index>, <ackstatus>, 500
AT^SMGSIMS	^SMGSIMS: ACK OK, <index>, 500
AT^SMGSIMS	^SMGSIMS: ACK OK <index>, <ackstatus>
(U)SIM Application Toolkit (SAT) Commands	
AT+STKPRO	+STKPRO: 01, <CmdQualifier>
AT+STKPRO	+STKPRO: 05, <EventList>
AT+STKPRO	+STKPRO: 19, <Alpha>, <IconId>, <RefNumber>
AT+STKPRO	+STKPRO: 21, <Url>, <Alpha>, <IconId>
AT+STKPRO	+STKPRO: 32, <Tone>, <TimeUnit>, <Interval>, <Alpha>, <IconId>
AT+STKPRO	+STKPRO: 33, <CmdQualifier>, <Dcs>, <HexString>, <IconId>
AT+STKPRO	+STKPRO: 34, <CmdQualifier>, <Dcs>, <HexString>, <IconId>
AT+STKPRO	+STKPRO: 35, <CmdQualifier>, <Dcs>, <HexString>, <MaxRespLen>, <MinRespLen>, <DefaultText>, <IconId>
AT+STKPRO	+STKPRO: 36, <CmdQualifier>, <Alpha>, <ItemId>, <TotalItems>, <ItemText>, <NextAction>, <DefaultItem>, <IconId>, <IconIdListElem>
AT+STKPRO	+STKPRO: 37, <CmdQualifier>, <Alpha>, <ItemId>, <TotalItems>, <ItemText>, <NextAction>, <IconId>, <IconIdListElem>
AT+STKPRO	+STKPRO: 38, <CmdQualifier>
AT+STKPRO	+STKPRO: 40, <Dcs>, <HexString>, <IconId>
AT+STKPRO	+STKPRO: 52, <CmdQualifier>, <Alpha>, <IconId>, <AtCommand>
AT+STKPRO	+STKPRO: 53, <Lang>
AT+STKCC	+STKCC: 2, <ResVal>, <Alpha>, <SsCode>
AT+STKCC	+STKCC: 3, <ResVal>, <Alpha>, <UssdCode>
AT+STKCC	+STKCC: 4, <ResVal>, <Alpha>, <ToSca>, <Sca>, <ToRa>, <Ra>
AT+STKCNF	+STKCNF: <ProactCmd>, <Result>, <AddResult>, <Sw1>
Hardware related Commands	
AT^SCTM	^SCTM_B: <UrcCause>
AT^SCTM	^SHUTDOWN

AT Command	URC
AT^SRADC	^SRADC: <count>, <value>[, <value>[, <value>[, <value>[, <value>[, <value>[, <value>[, <value>[, <value>]]]]]]]]]
General Purpose I/O (GPIO) Pin related Commands	
AT^SSCNT	^SSCNT: <pulse>
AT^SCCNT	^SCCNT: <time>

18.6 Alphabetical List of AT Commands

Table 18.6: Alphabetical List of AT Commands

AT Command	Description	Section and Page
+++	Switch from data mode or PPP online mode to command mode	Section 7.3, page 101
A/	Repeat Previous Command Line	Section 15.1, page 279
AT&C	Set Data Carrier Detect (DCD) Line Mode	Section 4.2, page 72
AT&D	Set Data Terminal Ready (DTR) Line Mode	Section 4.3, page 73
AT&F	Reset AT Command Settings to Factory Default Values	Section 2.1, page 26
AT&S	Set Data Set Ready (DSR) Line Mode	Section 4.4, page 74
AT&V	Display current configuration	Section 2.2, page 27
AT&W	Store AT Command Settings to User Defined Profile	Section 2.3, page 29
AT+CCID	(U)SIM Card Identification Number	Section 12.1, page 252
AT+CCLK	Real Time Clock	Section 16.1, page 288
AT+CEER	Extended Error Report	Section 3.1, page 62
AT+CEREG	EPS Network Registration Status	Section 10.6, page 187
AT+CESQ	Extended Signal Quality	Section 8.3, page 106
AT+CFUN	Functionality Level	Section 2.7, page 33
AT+CGACT	PDP context activate or deactivate	Section 10.1, page 178
AT+CGATT	GPRS attach or detach	Section 10.2, page 180
AT+CGAUTH	Define PDP Context Authentication Parameters	Section 10.16, page 209
AT+CGCMOD	PDP Context Modify	Section 10.5, page 186
AT+CGCONTRDP	PDP context read dynamic parameters	Section 10.12, page 200
AT+CGDATA	Enter data state	Section 10.17, page 211
AT+CGDCONT	Define PDP Context	Section 10.3, page 181
AT+CGDSCONT	Define Secondary PDP Context	Section 10.4, page 184
AT+CGEQOS	Define EPS Quality of Service	Section 10.10, page 196
AT+CGEQOSRDP	EPS Quality of Service Read Dynamic Parameters	Section 10.11, page 198
AT+CGEREP	Packet Domain Event Reporting	Section 10.7, page 189
AT+CGMI	Request manufacturer identification	Section 5.2, page 82
AT+CGMM	Request model identification	Section 5.3, page 83
AT+CGMR	Request revision identification of software status	Section 5.4, page 84
AT+CGPADDR	Show PDP Address	Section 10.8, page 192
AT+CGPIAF	Select Printing IP address format	Section 10.9, page 194
AT+CGSCONTRDP	Secondary PDP Context Read Dynamic Parameters	Section 10.13, page 202
AT+CGSMS	Select Service for MO Short messages	Section 10.18, page 213
AT+CGSN	Request International Mobile Equipment Identity (IMEI)	Section 5.5, page 85
AT+CGTFT	Traffic Flow Template	Section 10.14, page 203
AT+CGTFTTRDP	Traffic Flow Template Read Dynamic Parameters	Section 10.15, page 206
AT+CIMI	Request International Mobile Subscriber Identity (IMSI)	Section 5.7, page 89
AT+CLCK	Facility lock	Section 6.3, page 94
AT+CMEE	Error Message Format	Section 2.9, page 36

AT Command	Description	Section and Page
AT+CMGC	Send SMS Command	Section 11.2, page 219
AT+CMGD	Delete short message	Section 11.3, page 220
AT+CMGF	Select SMS message format	Section 11.4, page 221
AT+CMGL	List SMS messages from preferred store	Section 11.5, page 222
AT+CMGR	Read SMS messages	Section 11.6, page 224
AT+CMGS	Send SMS	Section 11.7, page 226
AT+CMGW	Write Short Messages to Memory	Section 11.8, page 227
AT+CMMS	More Messages to Send	Section 11.9, page 229
AT+CMSS	Send short messages from storage	Section 11.10, page 230
AT+CNMA	New Message Acknowledgement to UE/TE	Section 11.11, page 231
AT+CNMI	SMS Event Reporting Configuration	Section 11.12, page 232
AT+CNUM	Read own numbers	Section 14.1, page 278
AT+COPN	Read operator names	Section 8.1, page 102
AT+COPS	Operator Selection	Section 8.2, page 103
AT+CPAS	Activity Status	Section 3.3, page 69
AT+CPIN	PIN Authentication	Section 6.1, page 90
AT+CPINR	Remaining PIN Entries	Section 6.2, page 92
AT+CPLS	Select Preferred Operator List	Section 8.5, page 110
AT+CPMS	Preferred SMS message storage	Section 11.13, page 235
AT+CPOL	Preferred Operator List	Section 8.4, page 108
AT+CPWD	Change Password	Section 6.4, page 97
AT+CRSM	Restricted SIM Access	Section 12.2, page 254
AT+CSCA	SMS Service Center Address	Section 11.14, page 237
AT+CSCS	Character Set	Section 2.10, page 41
AT+CSDH	Show SMS text mode parameters	Section 11.15, page 238
AT+CSIM	Generic (U)SIM Access	Section 12.3, page 256
AT+CSMP	Set SMS Text Mode Parameters	Section 11.16, page 239
AT+CSMS	Select Message Service	Section 11.17, page 241
AT+CTZR	Time Zone Reporting	Section 8.6, page 111
AT+CTZU	Automatic Time Zone Update	Section 8.7, page 113
AT+GSN	Request International Mobile Equipment Identity (IMEI)	Section 5.6, page 87
AT+ICF	Character Framing	Section 4.6, page 76
AT+IPR	Bit Rate	Section 4.7, page 78
AT+STKCC	SAT Call Control Notification	Section 13.5, page 274
AT+STKCNF	SAT Proactive Session Status	Section 13.6, page 275
AT+STKENV	SAT Envelope Command	Section 13.4, page 272
AT+STKPRO	SAT Proactive Command URCs	Section 13.2, page 261
AT+STKTR	SAT Terminal Response Commands	Section 13.3, page 267
AT+WS46	Select wireless network	Section 3.4, page 70
AT\Q	Flow Control	Section 4.1, page 71
AT^SBNR	Binary Read	Section 15.5, page 283
AT^SBNW	Binary Write	Section 15.6, page 285

AT Command	Description	Section and Page
AT^SBV	Battery/Supply Voltage	Section 16.2, page 290
AT^SCCNT	Configure Pulse Counter	Section 17.5, page 314
AT^SCFG	Extended Configuration Settings	Section 2.11, page 42
AT^SCPIN	Pin Configuration	Section 17.1, page 307
AT^SCTM	Critical Operating Temperature Monitoring	Section 16.3, page 291
AT^SFDL	Firmware Download	Section 15.7, page 287
AT^SGIO	Get IO State of a Specified Pin	Section 17.2, page 310
AT^SICA	Internet Connection Activate or Deactivate	Section 9.1, page 126
AT^SICS	Internet Connection Settings	Section 9.2, page 127
AT^SIMSCFGSMS	Configure 3GPP2 SMS over IMS	Section 11.24, page 250
AT^SIND	Extended Indicator Control	Section 3.2, page 64
AT^SIPS	Internet Profile Storage	Section 9.3, page 129
AT^SISC	Internet Service Close	Section 9.7, page 143
AT^SISE	Internet Service Error Report	Section 9.13, page 156
AT^SISH	Disconnect Remote Client	Section 9.11, page 152
AT^SISI	Internet Service Information	Section 9.5, page 138
AT^SISO	Internet Service Open	Section 9.6, page 140
AT^SISR	Internet Service Read Data	Section 9.8, page 144
AT^SISS	Internet Service Setup Profile	Section 9.4, page 130
AT^SIST	Enter Transparent Mode	Section 9.10, page 150
AT^SISW	Internet Service Write Data	Section 9.9, page 147
AT^SISX	Internet Service Execution	Section 9.12, page 153
AT^SLED	LED Feature	Section 16.4, page 293
AT^SMGDIMS	Delete 3GPP2 SMS over IMS	Section 11.23, page 249
AT^SMGL	List Short Messages from preferred store without setting status to REC READ	Section 11.18, page 243
AT^SMGLIMS	List 3GPP2 SMS over IMS	Section 11.22, page 248
AT^SMGR	Read short message without setting status to REC READ	Section 11.19, page 244
AT^SMGRIMS	Read 3GPP2 SMS over IMS	Section 11.21, page 247
AT^SMGSIMS	Send 3GPP2 SMS over IMS	Section 11.20, page 245
AT^SMONI	Monitoring Serving Cell	Section 8.8, page 114
AT^SMONP	Monitoring Neighbour Cells	Section 8.9, page 117
AT^SMSO	Switch Off ELS31-V	Section 2.8, page 35
AT^SNMON	Network Monitoring	Section 8.10, page 120
AT^SPIO	GPIO Driver Open/Close	Section 17.6, page 316
AT^SPOW	Set UART Mode and SLEEP Mode on UART	Section 2.12, page 60
AT^SRADC	Configure and Read ADC Measurement	Section 16.5, page 295
AT^SSCNT	Start and Stop Pulse Counter	Section 17.4, page 312
AT^SSIO	Set IO State of a Specified Pin	Section 17.3, page 311
AT^SSPI	Serial Protocol Interface	Section 16.6, page 298
AT^SSTA	Remote-SAT Interface Activation	Section 13.1, page 259
ATD*99#	Request Packet Domain Service	Section 10.19, page 214

AT Command	Description	Section and Page
ATE	AT Command Echo	Section 4.5 , page 75
ATH	Disconnect existing connection	Section 7.1 , page 99
ATI	Display product identification information	Section 5.1 , page 80
ATO	Switch from command mode to data mode / PPP online mode	Section 7.2 , page 100
ATQ	Result Code Presentation Mode	Section 2.4 , page 30
ATS3	Command Line Termination	Section 15.2 , page 280
ATS4	Response Formatting	Section 15.3 , page 281
ATS5	Command Line Editing	Section 15.4 , page 282
ATV	Result code format mode	Section 2.5 , page 31
ATZ	Restore AT Command Settings from User Defined Profile	Section 2.6 , page 32

About Gemalto

Gemalto (Euronext NL0000400653 GTO) is the world leader in digital security with 2015 annual revenues of €3.1 billion and blue-chip customers in over 180 countries. Our 14,000+ employees operate out of 118 offices, 45 personalization and data centers, and 27 research and software development centers located in 49 countries.

We are at the heart of the rapidly evolving digital society. Billions of people worldwide increasingly want the freedom to communicate, travel, shop, bank, entertain and work - anytime, everywhere - in ways that are enjoyable and safe. Gemalto delivers on their expanding needs for personal mobile services, payment security, authenticated cloud access, identity and privacy protection, eHealthcare and eGovernment efficiency, convenient ticketing and dependable machine-to-machine (M2M) applications.

Gemalto develops secure embedded software and secure products which we design and personalize. Our platforms and services manage these secure products, the confidential data they contain and the trusted end-user services they enable. Our innovations enable our clients to offer trusted and convenient digital services to billions of individuals.

Gemalto thrives with the growing number of people using its solutions to interact with the digital and wireless world.

For more information please visit

m2m.gemalto.com, www.facebook.com/gemalto, or [Follow@gemaltom2m](https://twitter.com/Follow@gemaltom2m) on twitter.

Gemalto M2M GmbH
St.-Martin-Str. 60
81541 Munich
Germany

➔ M2M.GEMALTO.COM

gemalto
security to be free